

NEW VIDEOS ON
WWW.BARRETSPOORT.COM



ATTREZZATURE PER L'ALLENAMENTO DEI CAMPIONI
TRAINING TOOLS FOR CHAMPIONS



ATTREZZATURE PER L'ALLENAMENTO DEI CAMPIONI
TRAINING TOOLS FOR CHAMPIONS



BARRET SRL

Via Marie Curie, 6/8
Zona Ind.le S. Pietro in Palazzi
57023 Cecina (LI) - Italy
tel. (+39) 0586 661215
fax (+39) 0586 662417
info@barretsport.com
www.barretsport.com



FINITO DI STAMPARE NEL MESE DI LUGLIO 2024 - TIPOGRAFIA EUROSTAMPA GROUP - CECINA (LI)

**catalogo
2024-2025
brochure**

GET READY FOR THE MATCH!

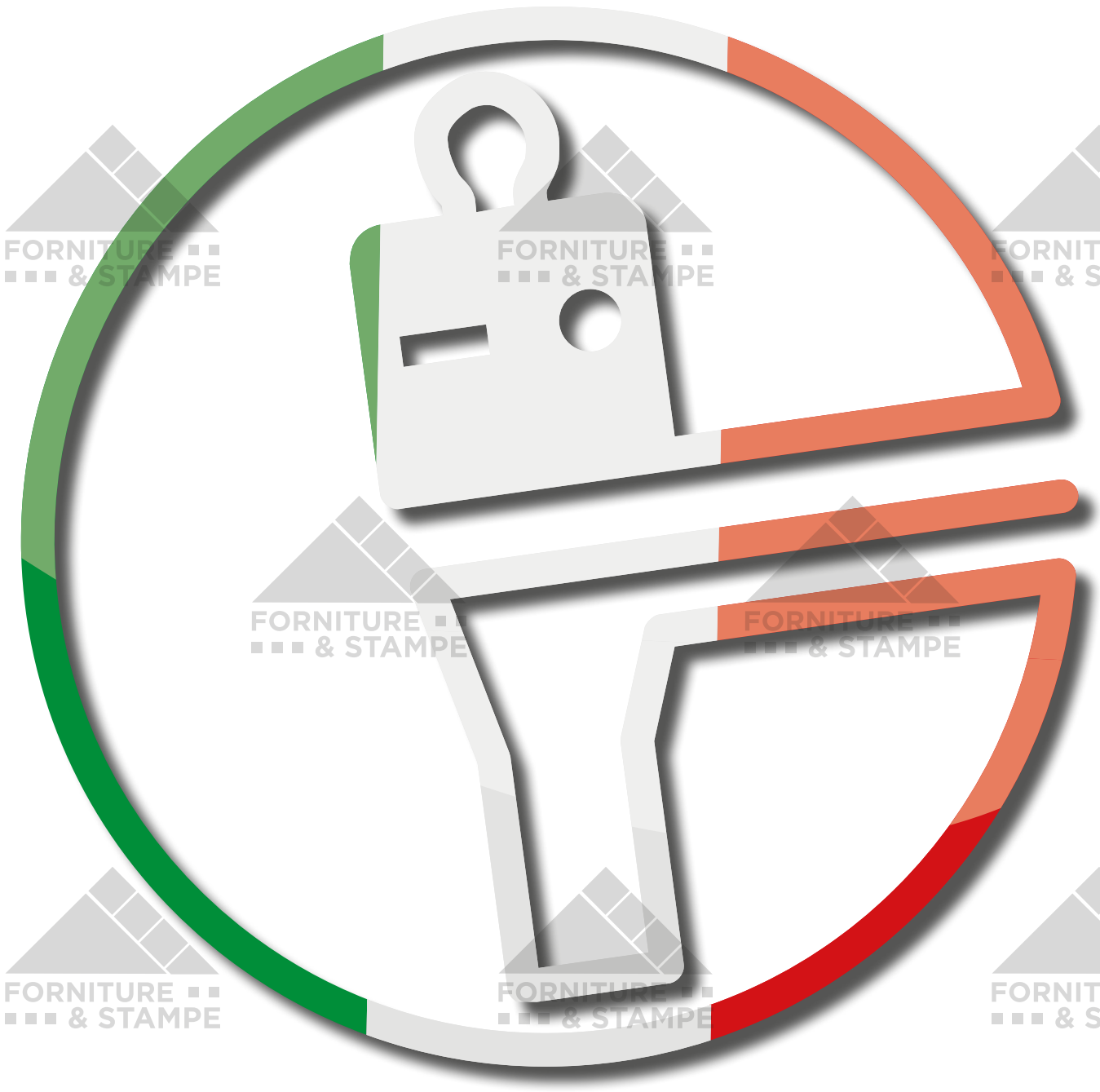
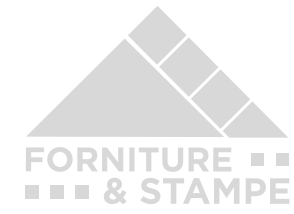
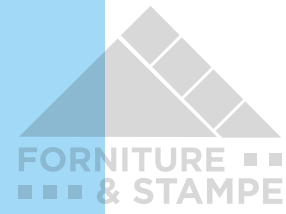
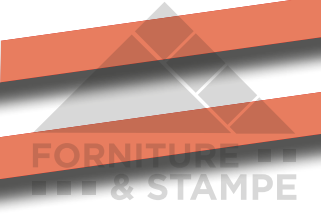
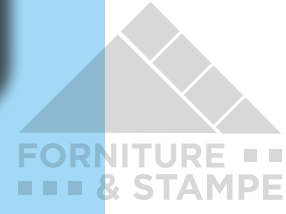
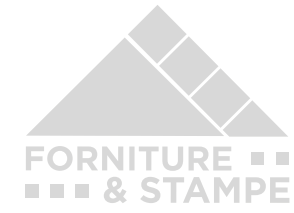
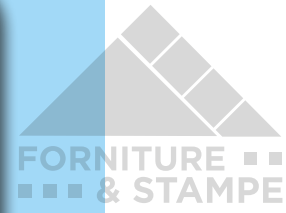
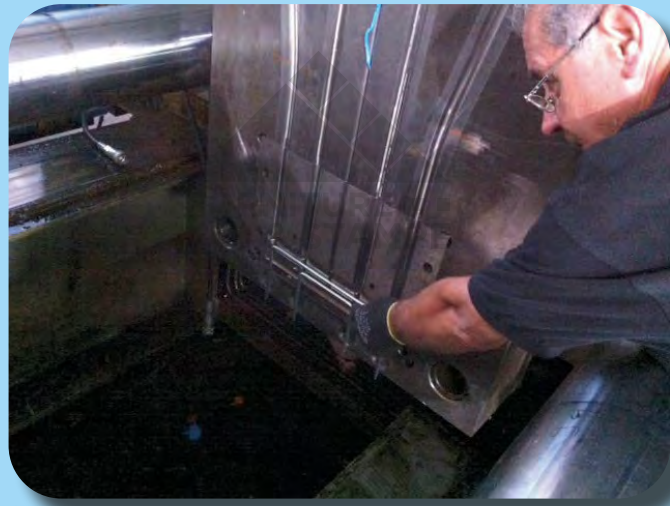

Barret Srl

Dal 1989 Barret Srl produce attrezzature tecniche per lo sport.

In particolare, l'Azienda si è affermata nel corso degli anni per la ideazione e realizzazione di strumenti di allenamento ormai divenuti indispensabili per la preparazione fisica, tecnica e tattica dei giocatori di calcio, così come per la preparazione degli atleti di molti altri sport, sia di squadra che individuali.

Barret offre la più ampia varietà di attrezzature quali sagome, ostacoli, delimitatori, birilli, paletti per slalom, archi di precisione, kit per calcio-tennis, forche, bande elastiche, slitte, plinti, tavolette propriocettive, telai con rete, muri in vetroresina, porte minicalcio, porte bifrontali, ridotte e regolamentari.

La qualità che contraddistingue i prodotti offerti e le numerose innovazioni proposte con continuità nel corso degli anni hanno permesso all'Azienda di affermarsi non solo sul mercato italiano, ma anche su quello internazionale.

Barret ha sviluppato nel tempo una preziosa collaborazione con Juventus FC, AC Milan e FC Internazionale fondamentale per permettere un interscambio di idee ed informazioni con i preparatori atletici della prima squadra e del settore giovanile, finalizzato al continuo miglioramento della funzionalità delle attrezzature tecniche per l'allenamento.

I prodotti Barret, infatti, vengono utilizzati quotidianamente sui campi di allenamento de La Continassa, di Milanello e di Appiano Gentile per coadiuvare la preparazione fisica e tecnica di alcuni tra i migliori giocatori di calcio del mondo.

Sarebbe impresa ardua ricordare tutti i Club nazionali ed internazionali e le Federazioni che hanno scelto più volte di acquistare le nostre attrezzature attraverso la rete distributiva italiana ed estera.

Cogliamo l'occasione per ringraziare i preparatori atletici ed i responsabili acquisti di Milan, Inter, Juventus, Roma, Lazio, Napoli, Sampdoria, Fiorentina, Udinese, Palermo, Torino, Empoli, Cagliari, Bologna, Sassuolo, Spal, Barcellona, Real Madrid, Bayern Monaco, PSG, Arsenal, Chelsea, Manchester City, Zenit e delle Nazionali di Calcio di Italia, Germania, Inghilterra, Francia, Spagna, Portogallo e Russia.

Company Profile

Founded in 1989, Barret Srl gained a foothold in the international football training equipment market by creating innovative tools which have become more and more essential during training sessions of pro athletes worldwide.

Barret manufactures products such as mannequins, hurdles, markers, cones, slalom poles, shooting arcs, soccer-tennis kits, heading trellises, all kinds of fiberglass and net rebounders, sledges, vaulting boxes, equilibrium boards, any size goals and mini goals.

The quality and variety of products introduced over the years make Barret the go-to company when a training camp is about to start.

Barret has a long history of working together with Juventus FC, AC Milan and FC Internazionale, three of the most prestigious clubs in football history: all the inputs and feedbacks received by their coaches always pushes Barret to shape and improve new products.

As a matter of fact Barret tools are used everyday at La Continassa, Milanello and Appiano Gentile Training Centers in order to constantly enhance some of the best world football players' athletic and technical performances.

It would be nearly impossible to name all professional Football Clubs and National Teams that have chosen to purchase Barret products through our distribution network.

However we would like to take this opportunity to thank clubs such as Milan, Inter, Juventus, Roma, Lazio, Napoli, Sampdoria, Fiorentina, Udinese, Palermo, Torino, Empoli, Cagliari, Bologna, Sassuolo, Spal, Barcellona, Real Madrid, Bayern Monaco, PSG, Arsenal, Chelsea, Manchester City, Zenit and the Italian, English, German, Spanish, Portuguese, French and Russian National Teams.

BARRET®

Le materie prime (i vari preparati plastici ed i profilati in polipropilene copolimero ed in PVC nei vari diametri, spessori e colori) utilizzate da BARRET per lo stampaggio e l'assemblaggio degli articoli in materiale plastico sono certificate dai nostri fornitori nel rispetto delle normative vigenti che impediscono l'utilizzo di sostanze ritenute tossiche per la salute dell'uomo e dell'ambiente.

Barret manufactures plastic products in PVC and polypropylene such as dummies, cones, markers, hurdles, slalom poles etc. using only certified non toxic raw materials not dangerous for human beings and the environment.



 **FORNITORE UFFICIALE**



Centro Sportivo Luigi Berlusconi - Monza



WWW.FORNITURESTAMPE.COM
UFFICIALE





FORNITORE UFFICIALE

FORNITURE ■ ■ ■ ■
& STAMPE

FORNITURE ■ ■ ■ ■
& STAMPE



FORNITURE ■ ■ ■ ■
& STAMPE

Centro Sportivo Luigi Berlusconi - Monza

BARRET srl
dal 1989
since 1989



BARRET
 ATTREZZATURE PER L'ALLENAMENTO DEI CAMPIONI
 TRAINING TOOLS FOR CHAMPIONS

BARRET s.r.l.
 Via Maria Curie, 6/8
 37070 Zenebio (Le) - P.le della Pace, 10
 37070 ZENEBO (LE) - Italy
 Telefono (+39) 0586 642117
 Fax (+39) 0586 642117
 E-mail: info@barrept.com
 Web: http://www.barrept.com

BARRET
 ATTREZZATURE PER L'ALLENAMENTO DEI CAMPIONI
 TRAINING TOOLS FOR CHAMPIONS

F.C. INTERNAZIONALE
 APPIANO GENTILE

BARRET s.r.l.
 Via Maria Curie, 6/8
 37070 Zenebio (Le) - P.le della Pace, 10
 37070 ZENEBO (LE) - Italy
 Telefono (+39) 0586 642117
 Fax (+39) 0586 642117
 E-mail: info@barrept.com
 Web: http://www.barrept.com

BARRET
 ATTREZZATURE PER L'ALLENAMENTO DEI CAMPIONI
 TRAINING TOOLS FOR CHAMPIONS

F.C. INTERNAZIONALE
 CAMPO DI ALLENAMENTO APPIANO GENTILE
 F.C. INTERNAZIONALE TRAINING CENTRE

BARRET s.r.l.
 Via Maria Curie, 6/8
 37070 Zenebio (Le) - P.le della Pace, 10
 37070 ZENEBO (LE) - Italy
 Telefono (+39) 0586 642117
 Fax (+39) 0586 642117
 E-mail: info@barrept.com
 Web: http://www.barrept.com

Catálogo 2009-2010
 2009-2010
 Brochure

BARRET
 ATTREZZATURE PER L'ALLENAMENTO DEI CAMPIONI
 TRAINING TOOLS FOR CHAMPIONS

“In ogni attività la passione è il più grande punto di partenza”

F.C. Internazionale
 Centro sportivo Angelo Moratti
 Appiano Gentile

A.C. Milan
 Centro Sportivo Milanello

BARRET s.r.l.
 Via Maria Curie, 6/8
 Zenebio (Le) - P.le della Pace, 10
 37070 ZENEBO (LE) - Italy
 Telefono (+39) 0586 642117
 Fax (+39) 0586 642117
 E-mail: info@barrept.com
 www.barrept.com

Catálogo 2010-2011
 2010-2011
 Brochure

BARRET
 ATTREZZATURE PER L'ALLENAMENTO DEI CAMPIONI
 TRAINING TOOLS FOR CHAMPIONS

BARRET s.r.l.
 Via Maria Curie, 6/8
 Zenebio (Le) - P.le della Pace, 10
 37070 ZENEBO (LE) - Italy
 Telefono (+39) 0586 642117
 Fax (+39) 0586 642117
 E-mail: info@barrept.com
 www.barrept.com

Catálogo 2013-2014
 2013-2014
 Brochure

BARRET
 ATTREZZATURE PER L'ALLENAMENTO DEI CAMPIONI
 TRAINING TOOLS FOR CHAMPIONS

BARRET s.r.l.
 Via Maria Curie, 6/8
 Zenebio (Le) - P.le della Pace, 10
 37070 ZENEBO (LE) - Italy
 Telefono (+39) 0586 642117
 Fax (+39) 0586 642117
 E-mail: info@barrept.com
 www.barrept.com

ESIBIZIONE
2014/2015
350000

BARRET
ATTREZZATURE PER L'ALLENAMENTO DEI CAMPIONI
TRAINING TOOLS FOR CHAMPIONS



F.C. INTERNAZIONALE
CAMPO DI ALLENAMENTO APRANO GENTILE
F.C. INTERNAZIONALE TRAINING CENTRE



BARRET s.r.l.
Via Maria Curie, 4/B
37023 Zene (td) - S. Pietro in Palazzi
CECINA (SI) - Italy
Telefono (+39) 0584.842417
Fax (+39) 0584.842417
E-mail: info@barretsport.com
www.barretsport.com

ESIBIZIONE
2014/2015
350000

BARRET
ATTREZZATURE PER L'ALLENAMENTO DEI CAMPIONI
TRAINING TOOLS FOR CHAMPIONS



Juventus Football Club - Torino
centro di allenamento
Training Center



BARRET s.r.l.
Via Maria Curie, 4/B
37023 Zene (td) - S. Pietro in Palazzi
CECINA (SI) - Italy
Telefono (+39) 0584.842417
Fax (+39) 0584.842417
E-mail: info@barretsport.com
www.barretsport.com

Esibizione
2014/2015
350000

BARRET
ATTREZZATURE PER L'ALLENAMENTO DEI CAMPIONI
TRAINING TOOLS FOR CHAMPIONS





BARRET s.r.l.
Via Maria Curie, 4/B
37023 Zene (td) - S. Pietro in Palazzi
CECINA (SI) - Italy
Telefono (+39) 0584.842417
Fax (+39) 0584.842417
E-mail: info@barretsport.com
www.barretsport.com

Juventus Training Center - Vinova (TO)

ESIBIZIONE
2014-2015
350000



BARRET
ATTREZZATURE PER L'ALLENAMENTO DEI CAMPIONI
TRAINING TOOLS FOR CHAMPIONS



BARRET s.r.l.
Via Maria Curie, 4/B
37023 Zene (td) - S. Pietro in Palazzi
CECINA (SI) - Italy
Telefono (+39) 0584.842417
Fax (+39) 0584.842417
E-mail: info@barretsport.com
www.barretsport.com

ESIBIZIONE
2015-2016
350000

BARRET
ATTREZZATURE PER L'ALLENAMENTO DEI CAMPIONI
TRAINING TOOLS FOR CHAMPIONS

BARRET s.r.l.
Via Maria Curie, 4/B
37023 Zene (td) - S. Pietro in Palazzi
CECINA (SI) - Italy
Telefono (+39) 0584.842417
Fax (+39) 0584.842417
E-mail: info@barretsport.com
www.barretsport.com

BARRET
ATTREZZATURE PER L'ALLENAMENTO DEI CAMPIONI
TRAINING TOOLS FOR CHAMPIONS



BARRET s.r.l.
Via Maria Curie, 4/B
37023 Zene (td) - S. Pietro in Palazzi
CECINA (SI) - Italy
Telefono (+39) 0584.842417
Fax (+39) 0584.842417
E-mail: info@barretsport.com
www.barretsport.com

BARRET srl
dal 1989
since 1989

NUOVI PRODOTTI - NEW PRODUCTS



pag. 88

Art. CGG24

Cuscino gonfiabile con maniglie cm.70x50 per contrasto alle uscite alte del portiere
Inflatable cushion 70x50 cm. with handles for football goalkeeper exit training

FORNITURE ■ ■ ■ & STAMPE

FORNITURE ■ ■ ■ & STAMPE

FORNITURE ■ ■ ■ & STAMPE

FORNITURE ■ ■ ■ & STAMPE

Art. S4DB

Scala doppia lunghezza m. 4 con 20 listelli piatti a distanza regolabile per esercizi di coordinazione motoria (compresa sacca per il trasporto)
Double speed ladder length 4 meters with 20 adjustable flat rungs for quick step and coordination exercises, bag included

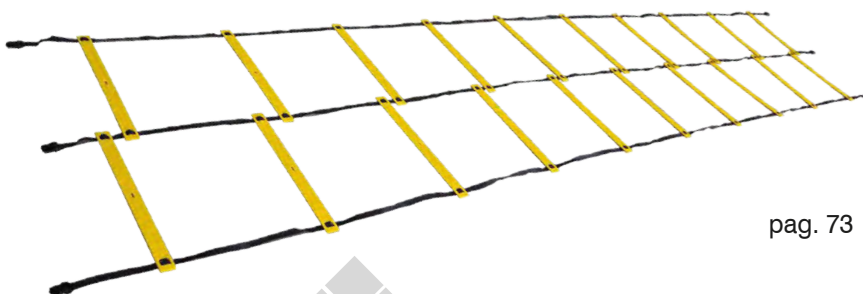

pag. 73

Art. S3PP Set 3 piattaforme pliometriche con 3 diverse altezze: cm. 30, cm. 45 e cm. 60 - rivestimento antiscivolo sulla parte superiore e cuscinetti in gomma sotto ciascuna piattaforma per una maggiore sicurezza - impilabili

per un pratico stoccaggio
Set of 3 plyometric platforms with 3 different heights: 30 cm., 45 cm. and 60 cm. anti-skid coating on top and rubber pads under each platform for added safety. Stackable for practical storage



pag. 70

Art. RC100

Bobina con fettuccia elastica per delimitazione temporanea campo da gioco.

Con questo nastro la marcatura può essere comodamente installata su campi senza gesso o vernice, e può essere rimossa senza lasciare residui dopo una partita o un allenamento. Il nastro può essere facilmente srotolato dalla bobina, e poi riavvolto con la stessa facilità.

Lunghezza 100 metri (ma può estendersi fino a circa il doppio) Larghezza cm. 2,5 - colore bianco - 25 picchetti in plastica inclusi per il fissaggio

Spool with elastic tape for temporary delimitation of the playing field. With this tape the marking can be conveniently installed on pitches with no chalk or paint, and can be removed without leaving residue after a match or training. The tape can be easily unwound from the spool, and then rewound just as easily.

Length 100 meters (but can extend to approximately double that) Width 2,5 cm. - white color - 25 plastic pegs included for fixing



pag. 164

FORNITURE ■ ■ ■ & STAMPE

FORNITURE ■ ■ ■ & STAMPE

FORNITURE ■ ■ ■ & STAMPE

FORNITURE ■ ■ ■ & STAMPE

FORNITURE ■ ■ ■ & STAMPE

FORNITURE ■ ■ ■ & STAMPE

FORNITURE ■ ■ ■ & STAMPE

FORNITURE ■ ■ ■ & STAMPE

NUOVI PRODOTTI - NEW PRODUCTS



- Art. **MBLT** MINI BAND LIGHT in poliestere ø cm.20,70 h.mm.50
 Art. **MBME** MINI BAND MEDIUM in poliestere ø cm.18,80 h.mm.50
 Art. **MBST** MINI BAND STRONG in poliestere ø cm.19,10 h.mm.50
 Art. **MBEX** MINI BAND EXTRA STRONG in poliestere ø cm.19,10 h.mm.54
 Polyester Mini Bands

pag. 81

Art. **ELAC** Fascia elastica ad anello in tessuto extra strong circonferenza cm. 400 - h. cm.5 pensata per l'allenamento multidirezionale consente lo sviluppo di forza, esplosività, velocità, agilità e salto

Elastic extra strong fabric loop band circumference 400 cm. - h. 5 cm. designed for multidirectional training allows the improvement of strength, explosiveness, speed, agility and jumping

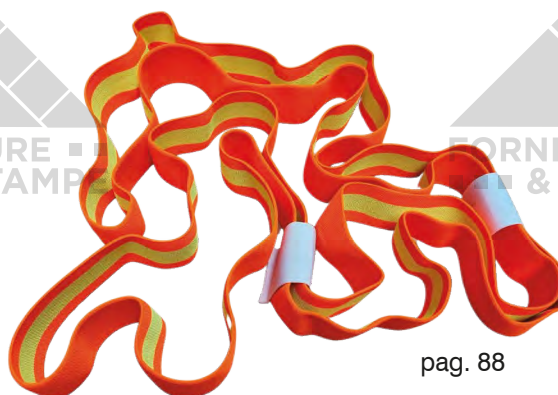

pag. 88



Art. **V6293 / V6294**

Panchina allenatori trasportabile su ruote lunghezza metri 3 profilo curvato mm.50x30 in lega di alluminio - altezza utile cm.210 copertura in policarbonato alveolare mm.4 oppure in policarbonato trasparente mm.3 sedute su 2 file (11 posti in totale)

Transportable dug-out on wheels length 3 meters, aluminium alloy frame 50x30 mm. height 210 cm.

4 mm. non transparent polycarbonate cover or 3 mm. transparent polycarbonate cover, seating in 2 rows (11 seats in total)

pag. 159



Art. **PBRCK** SET 2 RACCHETTE Pickleball, 6 palline, custodia

Art. **PBPLI** SET 6 PALLINE Pickleball indoor 26 fori

Art. **PBPLO** SET 6 PALLINE Pickleball outdoor 40 fori

Art. **PBSET** SET Pickleball con rete portatile, 4 racchette, 6 palline, set righe campo, custodie

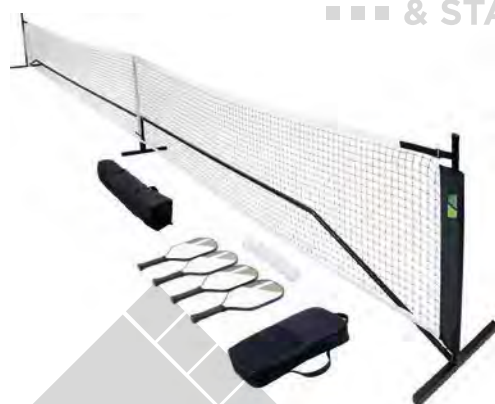

pag. 203

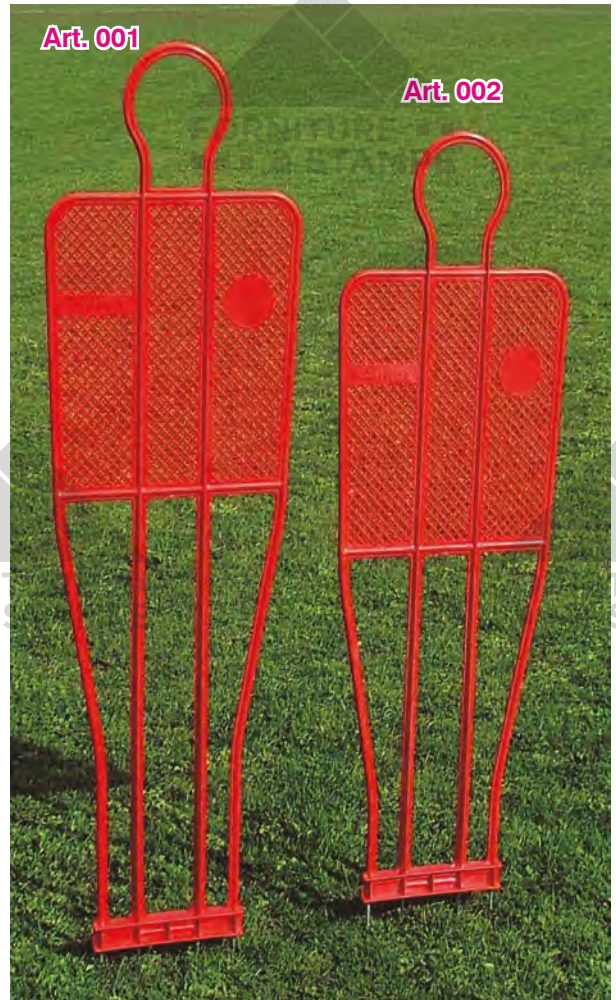
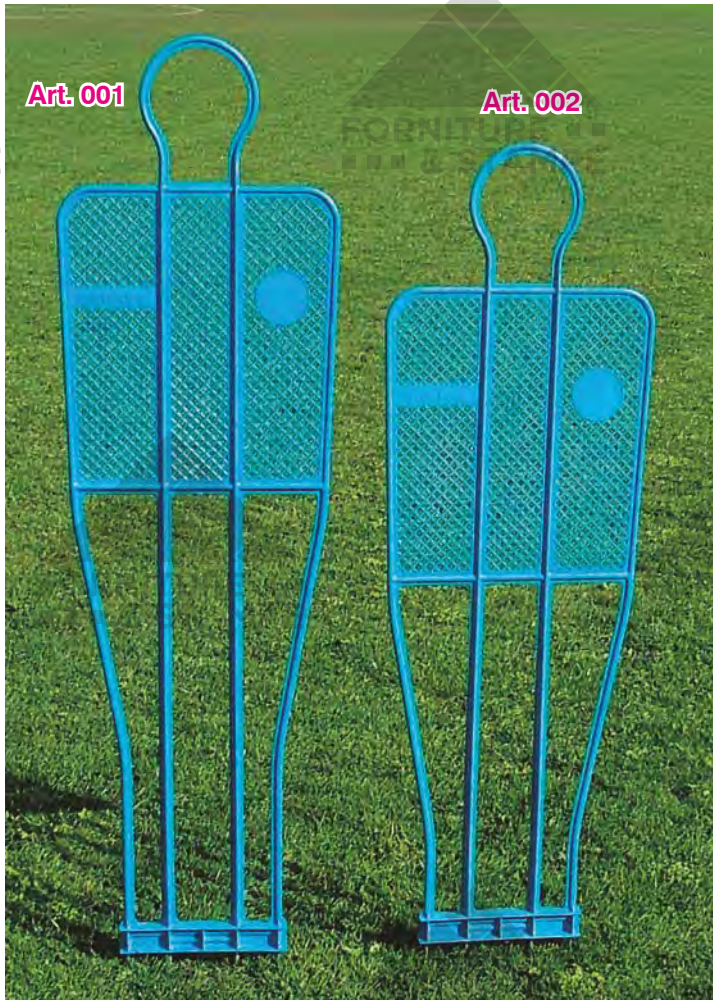

pg.1

**NUOVO MATERIALE PIÙ FLESSIBILE
NEW MORE ELASTIC PLASTIC MATERIAL**



Art. 001 **138,25€**
Sagoma Barret brevettata
cm. 180 Kg. 3,5
 Patented Barret Mannequin
 cm. 180 Kg. 3,5

Art. 002
Sagoma Barret brevettata
cm. 160 Kg. 3
 Patented Barret Mannequin
 cm. 160 Kg. 3

129,20€

Colori:
Rosso, Blu e Giallo
Colors:
Red, Blue and Yellow

SAGOME BARRET BREVETTATE
 leggere, flessibili, super-resistenti,
 antinfortunistiche!

PATENTED BARRET MANNEQUINS
 light, flexible, strong, safe!

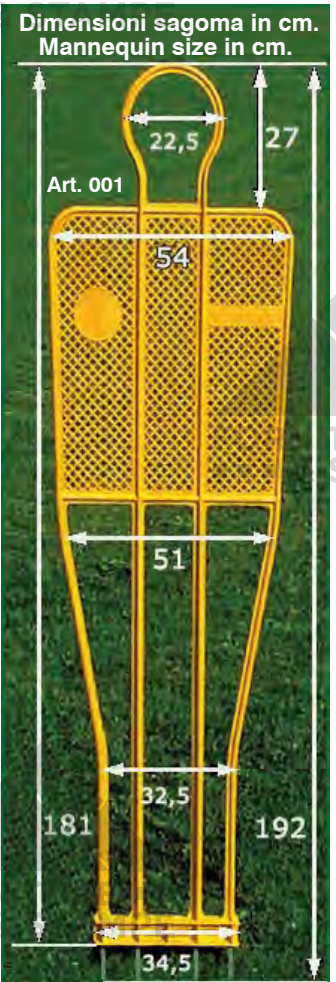

SAGOME E BARRIERE - Barriers



Art. 003 Carrello porta 5 sagome in acciaio zincato con ruote
Trolley for carrying 5 mannequins in galvanized steel, with wheels

530,00€



**4 puntali in acciaio zincato alla base
per posizionamento su
terreno naturale
o su carrello porta sagome**
4 galvanized steel spikes at the base,
for easy positioning on natural grass
or upon Barret trolley

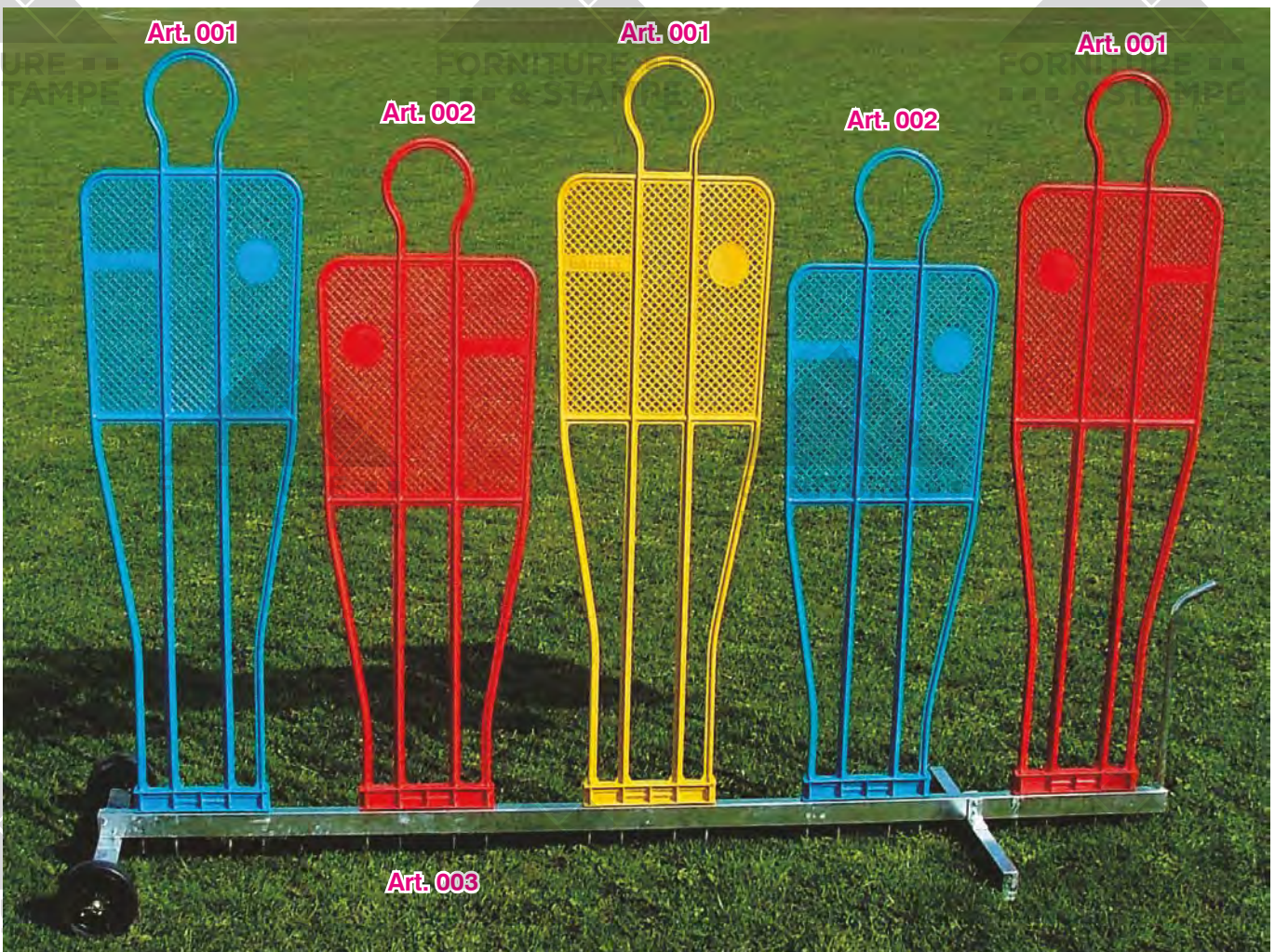

3 x Art. 001 + 2 x Art. 002 + Art. 003



Art. NCP3S
Carrello porta 3 sagome in acciaio zincato con ruote
Trolley for carrying 3 mannequins in galvanized steel, with wheels



509,00€

pg.1

Video dimostrativo disponibile su www.barretsport.com
Video available on www.barretsport.com

3 x Art. 001 + Art. NCP3S



Il carrello regolabile in altezza permette di simulare la presenza di giocatori in barriera che saltano al momento del calcio di punizione

This trolley allows free kick practicing by simulating jumping defenders

3 x Art. 001 + 2 x Art. 002 + Art. 003RG

Art. 003RG

Carrello porta 5 sagome in acciaio zincato con ruote - regolabile a 4 altezze (la sagoma Art. 001 può arrivare ad un'altezza massima da terra di cm.225)

612,00€

Trolley for carrying 5 mannequins in galvanized steel, with wheels - 4 adjustable heights (Art. 001 can reach up to 225 cm. height)

I numeri in giallo indicano la pagina di riferimento del Listino Prezzi 2024-2025

59,00€

56,25€



Art. 001R
Rivestimento per sagoma cm. 180 in nylon impermeabile antistrappo con cerniera
Colori: rosso, blu, giallo
Nylon Cover for cm. 180 mannequin with zip
Colors: red, blue, yellow

Art. 002R
Rivestimento per sagoma cm. 160 in nylon impermeabile antistrappo con cerniera
Colori: rosso, blu, giallo
Nylon Cover for cm. 160 mannequin with zip
Colors: red, blue, yellow



5 x Art. 001 + 5 x Art. 001R



5 x Art. 001 + 5 x Art. 001R + Art. 003RG

pg.1



Art. BPS001

Borsa porta 5 sagome in nylon impermeabile con tracolla e maniglie, rinforzi laterali in polipropilene rigido
Nylon carrying bag for 5 mannequins with shoulder belt and handles, waterproof, reinforced on both sides

pg.1

232,00€

SAGOME BARRET BREVETTATE
indispensabili per:
calci di punizione, slalom, dribbling, esercizi di anticipo, uscite aeree, schemi tattici ...

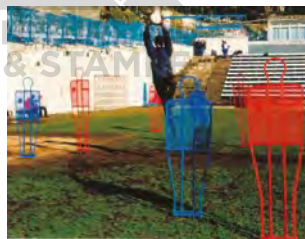

PATENTED BARRET MANNEQUINS

very useful for:
free kicks, slalom, dribbling, tackles, headers, goalkeeper exercises, tactics ...

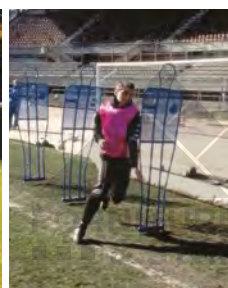

Numbers in yellow show the relevant page on 2024-2025 Price List



I numeri in giallo indicano la pagina d

322,00€

listino Prezzi 2024-2025



Art. 003S Carrello porta sagoma zincato con ruote, con molle antibaltamento
Trolley for single mannequin in galvanized steel with springs, on wheels

pg.1

Grazie alle molle il carrello Art. 003S impedisce alla sagoma di cadere a terra se colpita dalla palla
Thanks to the springs trolley Art. 003S allows mannequin to come back straight up when hit by the ball



Art. 001 + Art. 003S

Art. 003S

261,00€

Art. 001B Base per sagoma zavorrabile in acciaio zincato, per posizionamento su terreni sintetici
Peso: kg. 10 vuota, kg. 20 riempita con sabbia

Galvanized steel base to be filled with sand for mannequin positioning on artificial grass
Weight: 10 kg. empty 20 kg. filled with sand



Art. 001B

Art. 001 + Art. 001B



80,90€

Art. SF3454

Base zavorrata in caucciù per posizionamento sagoma su terreni sintetici - peso kg. 13

Rubber base for mannequin positioning on artificial grass - weight 13 kg.

pg.1

Art. 001 + Art. SF3454



Numbers in yellow show the relevant page on 2024-2025 Price List



207,50€

Art. 001FE
Sagoma Barret
 in acciaio zincato
 con 4 puntali
 altezza cm.180
 peso kg.5
 Barret mannequin
 180 cm. height
 in galvanized steel
 with 4 spikes
 weight 5 Kg.



Art. 001FE



Art. 001FE
 + **Art. 001B**



Art. 001FE
 + **Art. 001R**
 + **Art. 001B**

pg.1



207,50€

Art. 002FE

Sagoma Barret in acciaio
 zincato con 4 puntali
 altezza cm.160
 peso kg.4,5

Barret mannequin
 160 cm.
 height in galvanized steel
 with 4 spikes weight 4,5 Kg.



3 x Art. 001FE + **2 x Art. 001R**
2 x Art. 002FE + **2 x Art. 002R**
 + **Art. 003**



374,80€

Art. 001TD Rivestimento tridimensionale per sagoma Art. 001
h. cm. 180 spessore cm. 20
in PVC bispalmato 600 gr/mq
imbottitura in gommapiuma d. 16 kg/mc
3D Cover 20 cm. thick
for mannequin Art. 001
180 cm. height

I rivestimenti tridimensionali simulano perfettamente il volume del corpo dei giocatori permettendo una serie di esercizi tecnici e tattici con e senza palla ancora più realistici e sicuri.
L'imbottitura è inoltre utile per proteggere la sagoma dagli urti della palla calciata ad alta velocità durante l'allenamento ai calci piazzati di potenza



pg.1

355,00€

Art. 002TD Rivestimento tridimensionale per sagoma Art. 002
h. cm. 160
spessore cm. 20
in PVC bispalmato
600 gr/mq
imbottitura in gommapiuma
d. 16 kg/mc
3D Cover 20 cm. thick
for mannequin Art. 002
160 cm. height

3D Covers
perfectly resemble
players' bodies allowing even
more realistic and safe
technical and
tactical exercises with and
without ball.
The soft sandwich
protections also avoid possible
damages caused by high
power free kick practising



617,00€

Art. GP170

Sagoma in gommapiuma
h. cm. 170 - rivestimento in PVC
con decorazione digitale
fronte-retro del giocatore,
zavorrata alla base con sabbia
con maniglie per il trasporto
colori disponibili: rosso, blu,
giallo, arancio, bianco
Ø base cm. 59 - peso kg. 31
Foam rubber Dummy
170 cm. height with PVC Cover
with player's sketch
weighted base with sand
with handles
available colors: red, blue,
yellow, orange, white
base Ø 59 cm. - weight 31 kg.

**Nessun problema di
forature, perdite d'aria
o lacerazioni**
No problems with
punctures, deflation or
lacerations

384,00€

Art. GP170SL

**Sagoma in gommapiuma
come Art. GP170
solo con logo
BARRET (senza
la decorazione
del giocatore)**
Foam rubber
Dummy same of
Art. GP170
only with BARRET
logo (without
player's sketch)



402,00€

Art. GP205SL

**Sagoma in gommapiuma
come Art. GP205
solo con logo
BARRET (senza
la decorazione
del giocatore)**
Foam rubber
Dummy same of
Art. GP205
only with BARRET
logo (without
player's sketch)

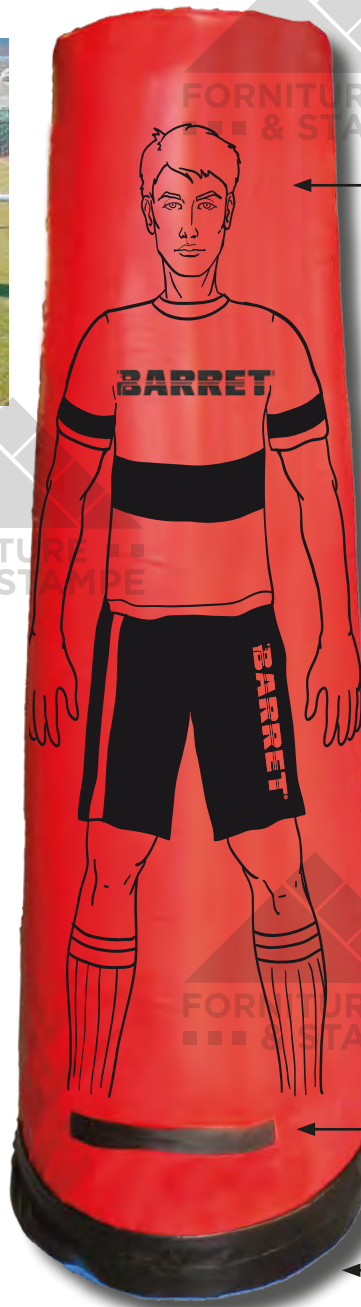

Rivestimento in PVC
PVC Cover outside

Imbottitura in poliuretano espanso
Foam rubber inside

pg.1

623,00€

Art. GP205

Sagoma in gommapiuma
h. cm. 205 - rivestimento in PVC
con decorazione digitale
fronte-retro del giocatore,
zavorrata alla base con sabbia
con maniglie per il trasporto
colori disponibili: rosso, blu,
giallo, arancio, bianco
Ø base cm. 59 - peso kg. 32
Foam rubber Dummy
205 cm. height with PVC Cover
with player's sketch
weighted base with sand
with handles
available colors: red, blue,
yellow, orange, white
base Ø 59 cm. - weight 32 kg.

**Maniglia
su entrambi i lati**
Handle on both
sides

Base zavorrata
Weighted base

pg.1

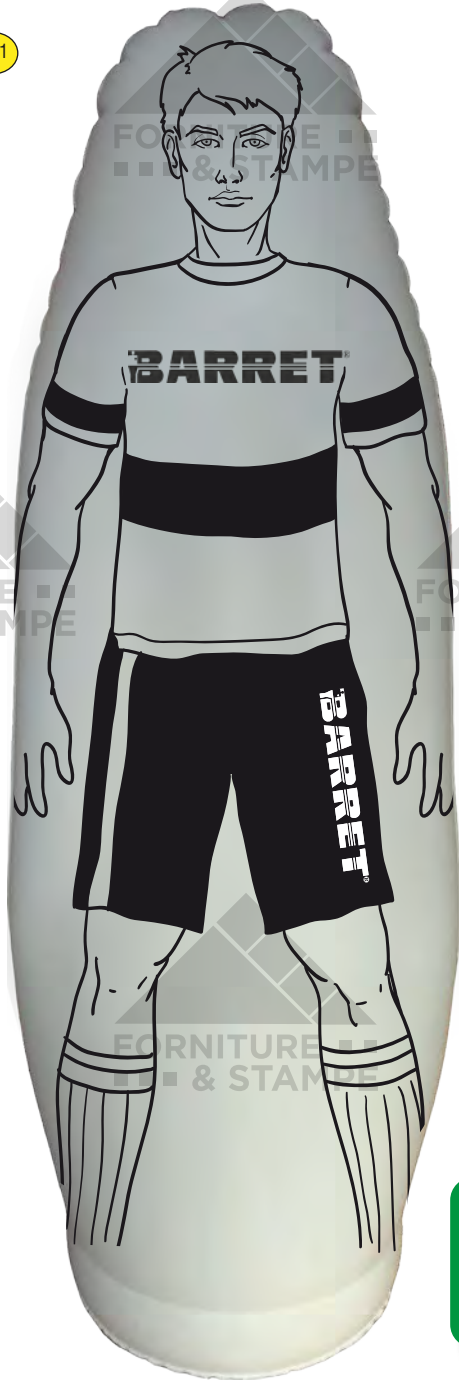

**SEMPRE IN PIEDI
POP UP DUMMIES**

pg.1

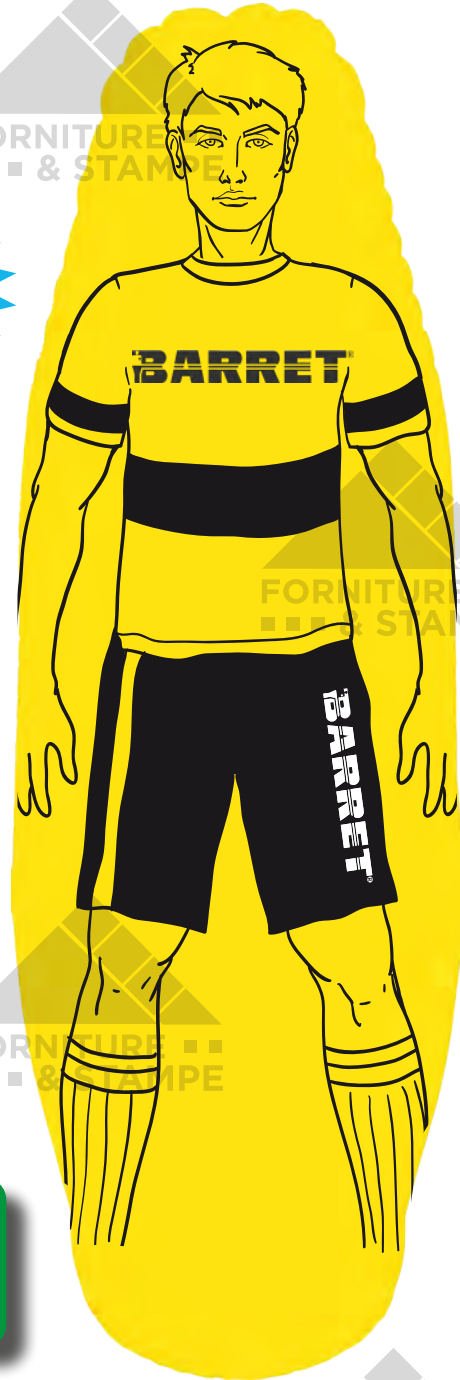

**Video dimostrativo
disponibile su
www.barretsport.com
Video available on
www.barretsport.com**

Art. SAG205

226,00€

Sagoma Gonfiabile

in PVC/PU h. cm.205 colore bianco

Inflatable dummy 205 cm. height white color

Ø base cm. 56 - peso kg. 23 (pronta all'uso)

base Ø 56 cm. - weight 23 Kg.

(when ready for use)

Art. SAG205YW

226,00€

Sagoma Gonfiabile

in PVC/PU h. cm.205 colore giallo

Inflatable dummy 205 cm. height yellow color

Ø base cm. 56 - peso kg. 23 (pronta all'uso)

base Ø 56 cm. - weight 23 Kg.

(when ready for use)

**Se colpite dalla palla o dal corpo dei giocatori
durante gli esercizi, le sagome gonfiabili Barret
tornano in piedi da sole**

Barret inflatable dummies always pop back up when hit
by ball or players' body during exercises

**Nate per l'allenamento dei portieri, le sagome
gonfiabili Barret possono essere utilizzate anche per
i calciatori per l'effettuazione di una molteplicità
di esercizi tecnici e tattici con e senza palla**

Born for GK training, Barret inflatable dummies are very
useful for lots of tactical and technical exercises involving
players with and without ball



**Particolare della valvola
superiore (rientrante) da
utilizzare per la gonfiatura
della sagoma e della
valvola inferiore (anch'essa
rientrante) da utilizzare per
il riempimento della base di
appoggio a terra con acqua**
The upper valve to inflate
the body with air, the bottom
valve to fill the base with
water

Video dimostrativo
disponibile su
www.barretsport.com
Video available on
www.barretsport.com

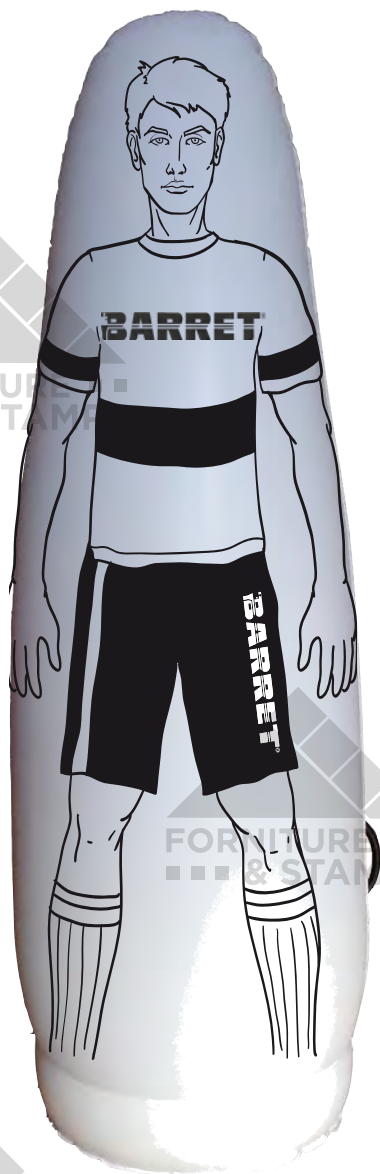

Ideale per i bambini
delle scuole calcio
Best for soccer school kids

SEMPRE IN PIEDI
POP UP DUMMIES



pg.1

Art. SAG175

161,90€

Sagoma Gonfiabile
in PVC/PU h. cm.175
Inflatable dummy 175 cm. height

Ø base cm. 45 - peso kg. 11
(pronta all'uso)
base Ø 45 cm. - weight 11 Kg.
(when ready for use)

Art. SAG115

101,40€

Sagoma Gonfiabile
in PVC/PU h. cm.115
Inflatable dummy 115 cm. height

Ø base cm. 40 - peso kg. 7
(pronta all'uso)
base Ø 40 cm. - weight 7 Kg.
(when ready for use)

Per un ordine minimo di 100 pezzi per misura
le sagome gonfiabili possono essere personalizzate

Inflatable dummies can be customized:
minimum order 100 pieces for each size

ISTRUZIONI PER LA GONFIATURA E L'UTILIZZO DELLE SAGOME GONFIABILI

IMPORTANTE: LA SAGOMA NON DEVE MAI ESSERE COMPLETAMENTE GONFIA. IL CORPO DEVE RIMANERE SEMPRE MORBIDO, ED I FIANCHI NON DEVONO ESSERE MARCATAMENTE SPORGENTI VERSO L'ESTERNO RISPETTO ALLA BASE

(UNA ECCESSIVA QUANTITÀ D'ARIA LOGORA LE SALDATURE ED ACCORCIA LA VITA DEL PRODOTTO)

- 1) Gonfiare la sagoma **solo moderatamente**
- 2) Tenendo la sagoma distesa a terra, inserire acqua nel serbatoio: quando la sagoma comincia ad inclinarsi verso l'alto, chiudere il tappo del serbatoio e disporla in posizione verticale
- 3) Provare a spingere la sagoma lateralmente e osservare come torna in posizione eretta
- 4) Se si vuole che la sagoma si rialzi più velocemente, aggiungere dell'acqua (a discapito del peso) e gonfiare un po'
- 5) Se si gonfia ulteriormente la sagoma, distenderla a terra e fare uscire l'aria in eccesso dal serbatoio dell'acqua (il fondo deve essere piatto, non bombato)
- 6) E' importante **utilizzare la minima quantità di acqua** che permette alla sagoma di risalire nel modo desiderato (un peso eccessivo e non giustificato può logorare inutilmente le saldature, accorciando la vita del prodotto)
- 7) Una volta trovato l'equilibrio desiderato, la sagoma può essere sgonfiata e rigonfiata (ad esempio, per trasportarla in luogo lontano) senza più svuotare il serbatoio dell'acqua
- 8) Non utilizzare le sagome se la temperatura è più bassa di 5 °C (e in ogni caso non usarle se l'acqua nel serbatoio è ghiacciata)
- 9) Non colpire le sagome con corpi appuntiti, non avvicinarle a fonti di calore, non trascinarle ma sollevarle sempre con le maniglie quando occorre spostarle, non sbatterle violentemente a terra, non lasciarle esposte al sole per giorni
- 10) Per le riparazioni utilizzare l'apposito kit o Loctite 406 (altri prodotti non hanno efficacia sul materiale) Il prodotto è garantito solo per un utilizzo diligente che rispetti le istruzioni fornite



Art. KSG
Kit di riparazione
(collante +
3 porzioni di
rivestimento)
Inflatable dummy
repairing kit
STAMPE



**SEMPRE IN PIEDI
POP UP DUMMIES**



USER'S INSTRUCTIONS

IMPORTANT: YOU ALWAYS HAVE TO KEEP THE BODY OF YOUR DUMMY VERY SOFT (NOT FULLY INFLATED) AND HIPS HAVE TO BE IN A STRAIGHT LINE WITH THE BASE (THEY MUST NOT BE ROUNDED)
(AN EXCESSIVE AMOUNT OF AIR WILL WEAR OUT THE WELDS AND SHORTEN THE TOOL'S LIFE)

Inflatable dummies are entirely made of soft PVC/PU: there are no rigid parts, so these products are absolutely safe. First, you have to inflate your dummy but **not completely**. Then, by keeping it lying on the floor, you have to put some water in the tank: when the dummy rises up, close the valve and place it upright.

If you want your dummy to rise up more quickly when hit, add some water and inflate the body a little more. In this case, let the dummy lie on the floor for a while and let some air out from the tank (the base must be flat, not rounded). It's important you **to use the minimum amount of water** that allows your dummy to rise the desired way (an excessive and unjustified weight will wear out the welds, shortening the tool's life).

Once the desired balance has been found, the dummy can be deflated and re-inflated without emptying the water tank (for example, when you need to transport it to a distant place).

Dummies can be used both on natural and artificial grass, on turf, gym floors etc.

Two side handles made of soft PVC are very useful to carry your dummy around: it is important to always lift your dummy when you need to move it (never pull it!) so the base doesn't get damaged.

Do not use dummies if the temperature is lower than 5 °C (and in any case do not use them if the water in the tank is frozen). It is also available a kit for repair when inflatable dummies get damaged because used in wrong ways, in example when they are torn apart by players kicking with their studs against them.



pg.1

preventivo

Art. 706244

Sagoma in plastica rinforzata antiurto su carrello a 4 ruote
altezza cm.190
peso totale Kg.22
(kg.7 la sagoma - Kg.15 il carrello)
spessore sagoma cm.9
 Mannequin in reinforced plastic 9 cm. thick with 4 wheel trolley height 190 cm. weight 22 Kg.

LATO ANTERIORE
FRONT

LATO POSTERIORE
BACK

pg.1

Art. 5026
Sagoma Barret
in vetroresina
h. cm. 185
 Barret
 fiberglass
 Mannequin
 185 cm. height

585,00€

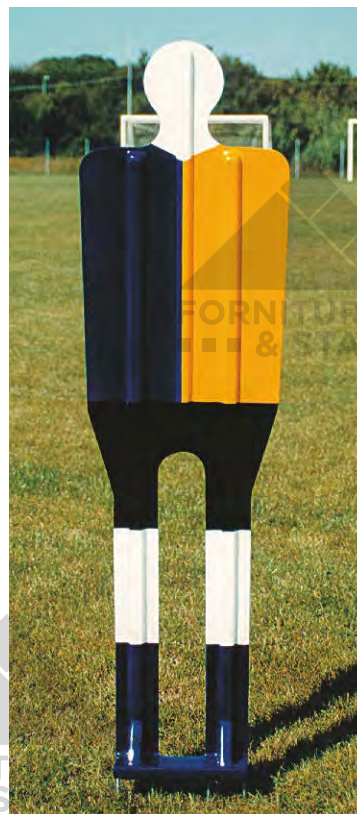

Indistruttibili!
Unbreakable!

4 puntali in acciaio zincato alla base, per posizionamento su terreno naturale o su carrello portasagome

4 galvanized steel spikes at the base, for quick positioning on natural grass or trolley



90,60€

Art. 001SP
Sagoma soft con telo PVC forato antivento su 2 paletti in PVC h. cm. 170 con puntale
 Soft pierced antiwind PVC Mannequin on 2 PVC poles 170 cm. high with metal spike

Art. 001SPA **109,00€**
Sagoma soft con telo PVC forato antivento su 2 paletti in alluminio h. cm. 170 con puntale
 Soft pierced antiwind PVC Mannequin on 2 aluminium poles 170 cm. high with metal spike



80,90€

Art. 001SP3
Sagoma soft con telo PVC forato antivento su 2 paletti in PVC h. cm. 130 con puntale
 Soft pierced antiwind PVC Mannequin on 2 PVC poles 130 cm. high with metal spike

85,60€

Art. 001SP6
Sagoma soft con telo PVC forato antivento su 2 paletti in PVC h. cm. 160 con puntale
 Soft pierced antiwind PVC Mannequin on 2 PVC poles 160 cm. high with metal spike

pg.1



185,00€

Art. SA001
Supporto per sagoma soft in ferro verniciato utilizzabile su terreno sintetico
 Base in painted iron for positioning any soft mannequin on artificial grass

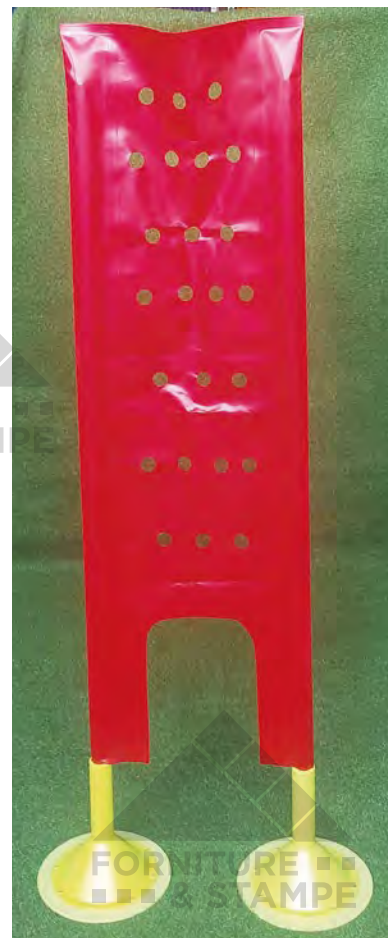

144,00€

Art. BA001SP
Sagoma soft con telo in PVC h. cm.183 su 2 paletti in PVC senza puntale e 2 basi Art. SP202
 Soft pierced antiwind PVC Mannequin 183 cm. height on 2 PVC poles and 2 bases Art. SP202

Art. BA001SPA
Sagoma soft con telo in PVC h. cm.183 su 2 paletti in alluminio senza puntale e 2 basi Art. SP202
 Soft pierced antiwind PVC Mannequin 183 cm. height on 2 aluminium poles and 2 bases Art. SP202

133,20€

PALETTI SLALOM - Slalom Poles



Art. 007
Paletto cm. 170
in PVC Ø mm. 32
con puntale zincato
colore giallo, giallo fluo,
rosso, bianco, blu, arancio
Pole 170 cm. high
in PVC with
galvanized metal spike
colors: yellow, fluo yellow,
red, white, blue, orange

7,40€

31,00€

Art. BFT
Borsa porta paletti
(capienza massima
30 pezzi)
Bag containing
up to 30 poles
(poles not included)



Art. 007SP
Paletto senza puntale
cm. 162
in PVC Ø mm. 32
colore giallo fluo,
rosso, bianco, blu
Pole 162 cm. high
in PVC
colors: fluo yellow,
red, white, blue

4,50€

pg.2

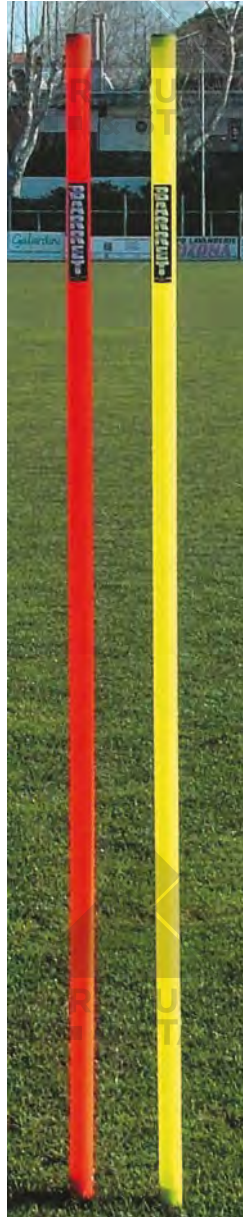

Art. 007F
Paletto in polipropilene
copolimero Ø 32 mm.
h.cm.163
con puntale zincato,
colore giallo fluorescente
o arancio fluorescente
Pole 163 cm. height in
copolymer polypropylene
32 mm. with galvanized metal
spike - colors: fluorescent
yellow and fluorescent orange

12,10€



Art. P007
Paletto cm. 160
in polipropilene
Ø mm. 30 con
puntale e piattello
di appoggio,
colore giallo fluo
Pole 160 cm. h.
in polypropylene
metal spike
with ring
color fluo yellow

24,40€



pg.2



cm. 170



cm. 90

12,85€

Art. 007TL
Paletto telescopico
 Ø 32 mm
 h. cm. 170 in PVC
 con puntale zincato
 (l'altezza si riduce
 fino a cm.90)
 colore giallo
 Telescopic Pole h. 170
 cm. in PVC with galvanized
 metal spike
 Height can be reduced
 down to 90 cm.
 color yellow



16,95€

Art. A007
Paletto cm. 170
 in alluminio Ø mm. 32
 con puntale zincato
 Pole 170 cm. high
 in aluminium with
 galvanized metal spike



14,60€

Art. S007
Paletto flessibile
 cm. 170 in
 PVC Ø mm. 32 con
 puntale
 zincato e molla,
 colore giallo o rosso
 Pole 170 cm. h.
 in PVC with
 galvanized metal
 spike and spring
 colors: yellow, red



Art. AS007
Paletto flessibile
 cm. 170 in
 alluminio Ø mm.
 32 con puntale
 zincato e molla
 Pole 170 cm. h.
 in aluminium with
 galvanized metal
 spike and spring

24,15€



pg.2



Art. 007.25
Paletto
 cm. 170
 smontabile
 in PVC
 Ø 25 mm
 con puntale
 zincato svitabile
 colore giallo
 Dismountable
 Pole 170 cm.
 height in PVC
 with removable
 galvanized metal
 spike
 color yellow

10,70€



I numeri in giallo indicano la pagina di riferimento del Listino Prezzi 2024-2025



7,60€

Art. 018

Base ad imbuto in plastica per paletto Ø 32 mm con o senza puntale
Funnel-shaped plastic base for pole with or without metal spike



17,55€

Art. 902013

Base cilindrica in plastica riempibile con sabbia o acqua, solo per paletto Ø 32 mm senza puntale
Cylindrical plastic base to be filled with sand or water, only for pole without metal spike

pg.2



17,15€

Art. HWRB

Base in gomma appesantita per paletto Ø 32 mm con o senza puntale
Weighted Rubber base for pole with or without metal spike

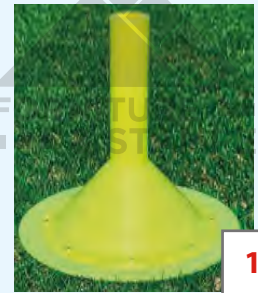

15,00€

Art. SP202 Base ad imbuto in plastica riempibile con sabbia, solo per paletto Ø 32 mm senza puntale
Funnel-shaped plastic base to be filled with sand, only for pole without metal spike



h. cm. 173

12,10€

Art. 010
Kit paletto PVC Ø 32 mm senza puntale
Art. 007SP + base Art. 018
Kit pole without metal spike + base Art. 018



h. cm. 170

22,05€

Art. 010C
Kit paletto PVC Ø 32 mm senza puntale
Art. 007SP + base Art. 902013
Kit pole without metal spike + base Art. 902013

21,65€



h. cm. 176

Art. 010WR
Kit paletto PVC Ø 32 mm senza puntale
Art. 007SP + base Art. HWRB
Kit pole without metal spike + base Art. HWRB



h. cm. 173

Art. S111P Kit paletto PVC Ø 32 mm senza puntale
Art. 007SP + base Art. SP202
Kit pole without metal spike + base Art. SP202

19,50€

Numbers in yellow show the relevant page on 2024-2025 Price List

FORNITURE ■ ■ ■ ■
■ ■ ■ ■ & STAMPE



Art. TAH-X

8,60€

Base riempibile con sabbia per aste Ø 25 mm. e cerchi piatti o tubolari
colori: giallo, blu e rosso
Base to be filled with sand for poles Ø 25 mm. and flat or tubular hoops
colors: yellow, blue and red



Art. TAH25

13,60€

KIT ASTA in PVC Art. SP25
+ **BASE** riempibile Art. TAH-X
Kit PVC pole Art. SP25
+ Base Art. TAH-X



pg.2

5,00€

Art. SP25
Asta in PVC Ø 25 mm.
altezza cm. 152
colori: giallo, blu e rosso
PVC pole Ø 25 mm.
height 152 cm.
colors: yellow, blue and red

FORNITURE ■ ■ ■ ■
■ ■ ■ ■ & STAMPE

FORNITURE ■ ■ ■ ■
■ ■ ■ ■ & STAMPE

FORNITURE ■ ■ ■ ■
■ ■ ■ ■ & STAMPE

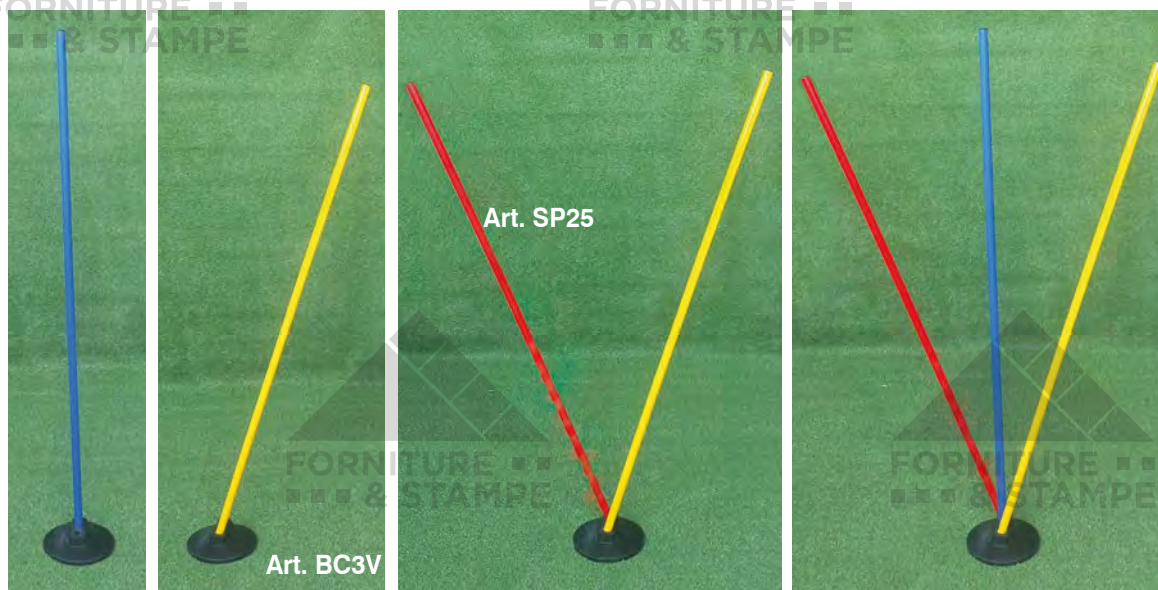

pg.2

Art. BC3V + Art. SP25



Art. BC3V

11,20€

Base in gomma appesantita per inserire fino a 3 aste in PVC diam. mm.25
con diverse angolazioni - peso Kg.1,3 diametro cm.22,5
Rubber weighted base to insert up to 3 PVC poles diam. 25 mm.
with different angles - weight 1,3 Kg. diameter 22,5 cm.

FORNITURE ■ ■ ■ ■
■ ■ ■ ■ & STAMPE

FORNITURE ■ ■ ■ ■
■ ■ ■ ■ & STAMPE

FORNITURE ■ ■ ■ ■
■ ■ ■ ■ & STAMPE



Art. 525
Ostacolo regolabile con paletti, clips e traversa in PVC Ø mm.32
 Hurdle with Poles, clips and crossbar in PVC Ø 32 mm.

20,90€

pg.2



23,60€

Art. 5025
Ostacolo regolabile con paletti graduati, clips e traversa in PVC Ø mm.32
 Hurdle with Graded Poles, clips and crossbar in PVC Ø 32 mm

h. cm. 10 → 160



Art. 012
Traversa in PVC cm.110 Ø mm. 32
 Crossbar 110 cm. in PVC Ø 32 mm.

4,30€



Art. 012F
Traversa in polipropilene copolimero cm. 110 Ø mm.32 giallo fluo o arancio fluo
 Crossbar 110 cm. in copolymer polypropylene Ø 32 mm. in fluo yellow and fluo orange

4,95€

pg.3



Art. 525F
Ostacolo regolabile con paletti h. cm. 163 con puntale, 1 traversa e 2 clips in polipropilene copolimero colore giallo fluo o arancio fluo
 Hurdle with graded poles, clips and crossbar in copolymer polypropylene Ø 32 mm. (colors: fluo yellow and fluo orange)

30,95€

pg.2

h. cm. 10 → 160



Art. ELNR
ELASTICO nero con velcro lunghezza cm.135 da fissare ai paletti come traversa ad altezza regolabile
 Black band length 135 cm. with velcro to be used as adjustable height crossbar

21,00€

pg.3

 I numeri in giallo indicano la pagina di riferimento del Listino Prezzi 2024-2025

Art. OSPT15 Delimitatore circolare piatto Ø cm.15 spessore mm.1 colori giallo, rosso, arancio, bianco, celeste
Flat round Marker Ø 15 cm. colors: red, yellow, orange, white, blue

2,00€



Art. 015KT
Kit 20 linee lunghe cm.40 + 4 angoli di cm.20+20 larghezza linee cm.4
Kit 20 lines + 4 angles

25,15€

3,90€

Art. 15HCR Rimessaggio in metallo per delimitatori piatti Art. OSPT15
Metal Holder for Art. OSPT15



pg.3

Art. DC25
Delimitatore circolare piatto Ø cm.25 spessore mm.1 colori giallo, rosso, arancio, bianco, blu
Flat round Marker Ø 25 cm. colors: red, yellow, orange, white, blue

2,75€



Art. 016.K
Delimitatore gigante con scanalature base Ø cm. 30 h. cm.16,5 peso gr. 100 colori: giallo, arancio e bianco
Giant Marker 16,5 cm. height carved on top and sides colors yellow, orange and white

3,30€

pg.3

Con l'uso di traverse consente la creazione di ostacoli di altezza cm. 5 / 10 / 15
Giant markers along with crossbars can create hurdles 5-10-15 cm. high

Art. 016.K

Art. E21

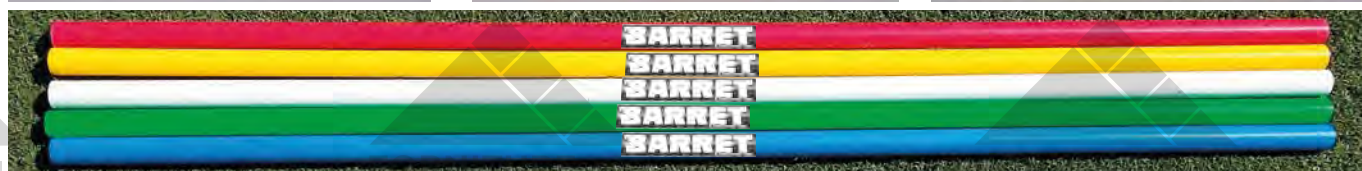

Art. E21 Traversa cm.120 in PVC Ø mm. 25 - colori giallo, rosso, blu, verde, bianco
Crossbar 120 cm. in PVC Ø 25 mm. - colors yellow, red, blue, green, white

3,40€

 Numbers in yellow show the relevant page on 2024-2025 Price List

BIRILLI - Cones

5,15€

Art. 205000

**Birillo calpestabile
in caucciù termoplastico**
base Ø cm. 14 - h. cm. 15
colori giallo e rosso
Soft Cone 15 cm. height
14 cm. Ø base
colors: red, yellow



Art. HA7

**Birillo calpestabile
in caucciù
termoplastico**
base Ø cm. 17
h. cm. 18
colori giallo e rosso
Soft Cone
18 cm. height and
17 cm. Ø base
colors: red, yellow

5,45€

pg.3



Art. 019.1

3,65€

Art. 019.1

Maxidelimitatore h. cm. 28
fornito singolarmente
colori: giallo, arancio, rosso,
royal e fucsia
Loose Maximarker height 28 cm.
colors: yellow, orange, red, blue
and fuchsia



Art. 019

87,25€

Kit 24 Maxidelimitatori h. cm. 28
colori: giallo, arancio, rosso, royal e fucsia
Kit 24 Maximarkers height 28 cm.
colors: yellow, orange, red, blue and fuchsia



Art. 023E

**Birillo economico
senza fori h. cm. 30**
colori rosso e giallo
Light Cone
30 cm. height
with no holes
colors: red,
yellow

3,95€



4,50€

Art. 023N

Birillo h. cm. 38 colore rosso, giallo o blu - Cone height 38 cm. colors: red, yellow, blue
Peso gr. 200 senza foro sulla sommità - Weight 200 gr. with no hole at top



Peso gr. 450
 Weight 450 gr.

5,55€

Art. 023

Birillo giallo h. cm. 40 con foro sulla sommità
 Yellow Cone 40 cm. height with hole at the top

5,55€

Art. 025

Birillo fucsia h. cm. 40 con foro sulla sommità
 Fuchsia Cone 40 cm. height with hole at the top

5,55€

Art. 024

Birillo rosso h. cm. 40 con foro sulla sommità
 Red Cone 40 cm. height with hole at the top

pg.3



in 4 colori
 in 4 colors

7,00€

Art. B312

Birillo a 8 fori h. cm. 30 con scanalatura sulla sommità
 Cone with 8 holes 30 cm. height carved on top



Art. E21 Traversa cm.120 in PVC Ø mm. 25 colori giallo, rosso, blu, verde, bianco
 Crossbar 120 cm. in PVC Ø 25 mm. - colors yellow, red, blue, green, white

3,40€

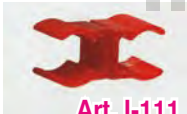

Art. I-111
Clip rotante
per aste
 Ø mm. 25 e 28
 Rotating clip
 for two pipes
 Ø mm. 25 and 28

2,15€



14,10€

Art. C21
Birillo a 16 fori
h. cm. 50
con scanalatura
sulla sommità
 Cone with 16 holes
 height 50 cm.
 carved on top

pg.3

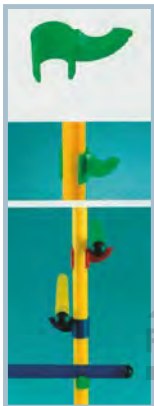

Art. I-110
Clip per montante
 Ø mm. 25 e 28
e traversa
 Clip for pipe
 Ø mm. 25 and 28
 and crossbar

2,15€

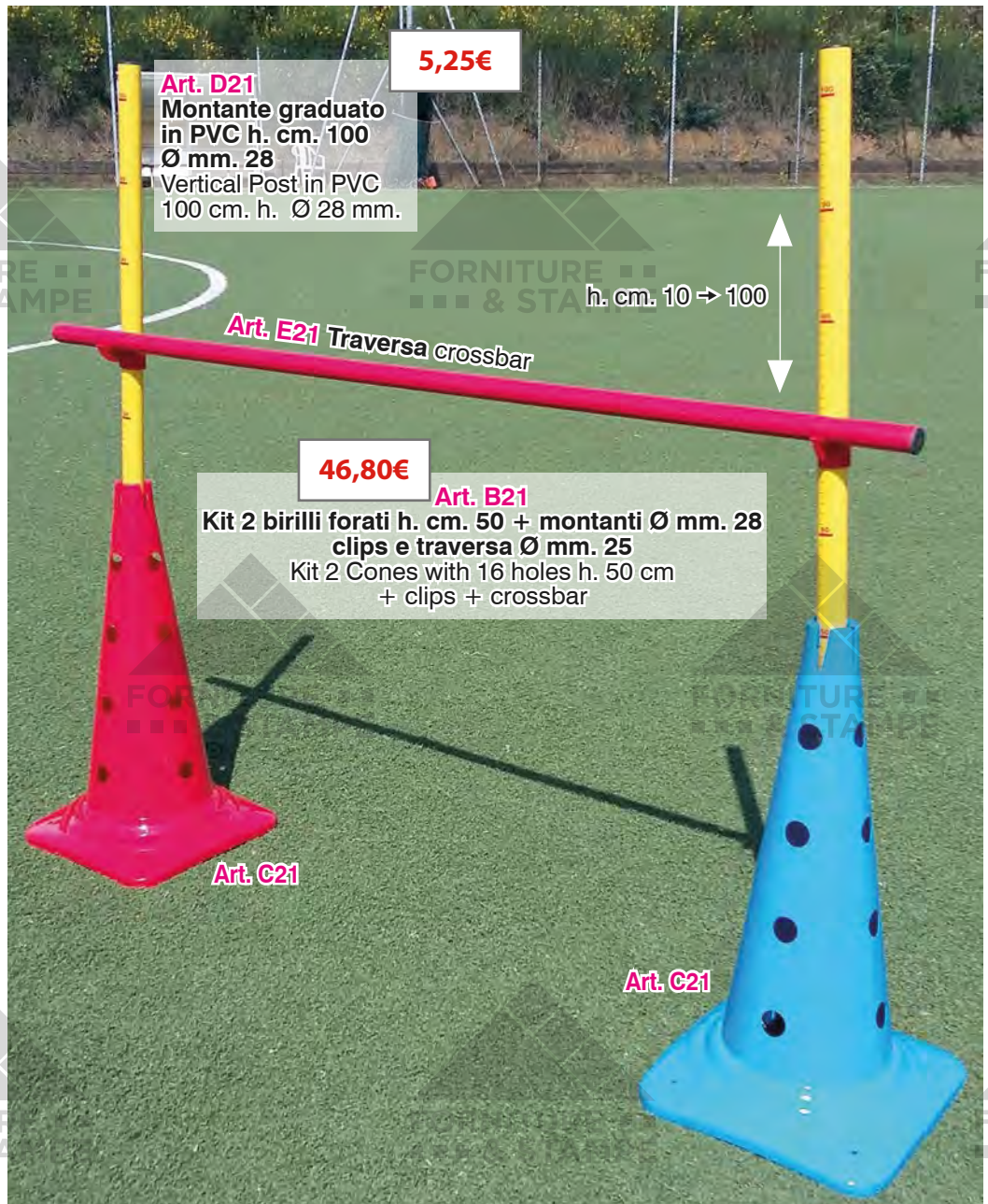

5,25€

Art. D21
Montante graduato
in PVC h. cm. 100
 Ø mm. 28
 Vertical Post in PVC
 100 cm. h. Ø 28 mm.

h. cm. 10 → 100

Art. E21 Traversa crossbar

46,80€

Art. B21
Kit 2 birilli forati h. cm. 50 + montanti Ø mm. 28
clips e traversa Ø mm. 25
 Kit 2 Cones with 16 holes h. 50 cm
 + clips + crossbar



Art. I-112
Clip per asta
 Ø mm. 25 e 28
e cerchio piatto
 Clip for pipe
 Ø mm. 25 and 28
 and flat hoop

2,15€



Art. 011
Clip per sostegno traversa per asta Ø mm. 32 e 28
Clip for crossbar for pipe Ø mm. 32 and 28



Art. CL17
Clip rotante per aste Ø mm. 32
Rotating clip for two pipes Ø 32 mm.

pg.2



OSTACOLI - Hurdles



pg.5

Art. MH6 / MH9 / MH12

Mini-Over in PVC
altezza fissa,
cm. 15 / 23 / 30

Ideali per i bambini
delle scuole calcio

9,75€

15cm

12,10€

23cm

Mini-Over in PVC
fixed height,
15 / 23 / 30 cm.
Best for soccer
school kids

13,40€

30cm



Tornano in posizione
dopo ogni urto
senza danneggiarsi
These hurdles come
back in position after
any hit without being
damaged

pg.4

Art. 80.12 / 80.14 / 80.16 / 80.18
80.20 / 80.30 / 80.40 / 80.50 / 80.60

Ostacolo Over in PVC
altezza fissa,
cm.12-14-16-18-20-30-40-50-60
Hurdle Over in PVC
fixed height,
12-14-16-18-20-30-40-50-60 cm.

12,95€

12cm

13,55€

14cm

13,65€

16cm

13,75€

18cm

14,65€

20cm

16,45€

30cm

19,30€

40cm

21,25€

50cm

21,90€

60cm

pg.4

Art.
P031-A / P031 / P032
P033 / P034 / P035

Ostacolo Over
in PVC Ø mm. 32
altezza fissa
disponibile
da 12 a 60 cm.
Hurdle Over in PVC,
fixed height
available
from 12 to 60 cm.

21,25€

12cm

21,25€

20cm

22,35€

30cm

24,75€

40cm

25,85€

50cm

27,00€

60cm



pg.4

Art. 031-A / 031 / 032 / 033 / 034 / 035
Ostacolo Over in polipropilene Ø mm. 40
altezza fissa disponibile da 12 a 60 cm.
Hurdle Over in polypropylene, fixed height
available from 12 to 60 cm.

Polipropilene
copolimero
Ø 40 mm.
altamente
resistente e
flessibile fino a
-5 gradi!
Polypropylene
copolymer
40 mm. highly
resistant and
elastic till minus
5 degrees!

30,70€	30,70€	33,50€	37,35€	39,90€	42,70€
12cm	20cm	30cm	40cm	50cm	60cm

pg.5

Art. 235-1 / 235.2 / 235.3 / 235.4 / 235.5 / 235.6
Ostacolo Over
in ferro verniciato altezza fissa
disponibile da 12 a 60 cm.
Hurdle Over in painted iron,
fixed height available
from 12 to 60 cm.

15,50€
12cm
16,55€
20cm
17,50€
30cm
21,25€
40cm
25,15€
50cm
31,00€
60cm

pg.4 pg.5

Art. A031-A / A031 / A031-B / A032 / A033 / A034 / A035
Ostacolo Over in alluminio Ø mm. 32 altezza fissa disponibile da 12 a 60 cm.
Hurdle Over in aluminium, fixed height available from 12 to 60 cm.

33,00€	22 a 28cm
34,00€	30cm
31,60€	12 a 18cm
31,60€	20cm
36,35€	40cm
37,90€	50cm
40,15€	60cm



pg.5

FORNITURE & STAMPE

Art. 239TI

Ostacolo con traversa inclinata altezza variabile da cm. 12 a cm. 60 in ferro verniciato - larghezza mt. 2 (scomponibile) Ordinare quantità multipla di 3 pezzi
 Hurdle with inclined crossbar height from 12 cm. to 60 cm. in painted iron - width 2 meters (dismountable in 3 pieces) Please order multiple quantities of 3 pieces

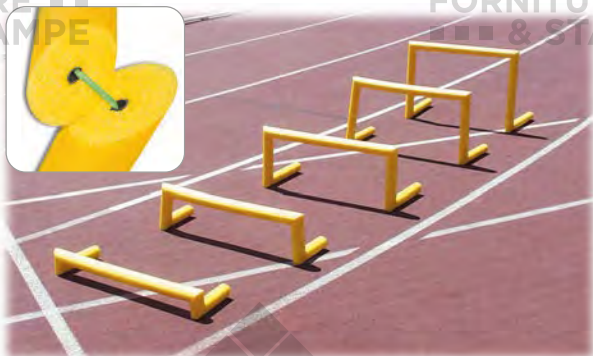

pg.5

112,15€

Art. P15421

Serie 5 ostacoli Over supersoft in polietilene espanso colore giallo, leggerissimi ideali per uso indoor
altezza cm. 10-20-30-40-50 (il set comprende un ostacolo per ciascuna altezza)
 Set of 5 Hurdles over supersoft yellow color very light, best for indoor use fixed height cm. 10-20-30-40-50

Art. 031-AF

**031F / 031-BF / 032F
033F / 034F / 035F**

Ostacolo Over altezza fissa cm. 12-20-30-40-50-60 in polipropilene copolimero alta resistenza Ø mm. 32 colori: giallo fluo e arancio fluo
 Over Hurdle 12 - 20 - 30 - 40 - 50 - 60 cm. height polypropylene copolymer pipe Ø mm. 32 (colors: fluo yellow and fluo orange)

22,25€

12 a 18cm

22,25€

20cm

23,00€

22 a 28cm

23,80€

30cm

26,30€

40cm

27,50€

50cm

28,90€

60cm

pg.4

FORNITURE & STAMPE

Polipropilene copolimero FLUO altamente resistente e flessibile fino a -5 gradi!
 Polypropylene copolymer fluorescent highly resistant and elastic till minus 5 degrees!



Art. C031 / C032 / C033 / C034

Ostacolo con cerniere (richiudibile) in polipropilene copolimero Ø mm. 32 colore giallo fluo o arancio fluo massima altezza cm. 20 - 30 - 40 - 50
Hinged Hurdle (foldable) in polypropylene copolymer pipe Ø mm. 32 fluo yellow and fluo orange 20 - 30 - 40 - 50 cm. maximum height

25,50€

20cm

27,20€

30cm

28,90€

40cm

30,70€

50cm



pg.4

FORNITURE & STAMPE



FORNITURE
& STAMPE

30,40€

Art. 006
Ostacolo con cerniere (richiudibile)
altezza regolabile da 10 a 60 cm.
in PVC Ø mm. 32
 Hinged Hurdle (foldable)
 adjustable height
 from 10 to 60 cm. in PVC



FORNITURE & STAMPE

pg.5

32,20€

Art. 006F

Ostacolo con cerniere (richiudibile)
altezza regolabile da 10 a 60 cm.
in polipropilene copolimero Ø mm. 32
colore giallo fluo o arancio fluo
 Hinged Hurdle (foldable) adjustable height
 from 10 to 60 cm. in polypropylene
 copolymer pipe Ø 32 mm.
 (colors: fluo yellow and fluo orange)



FORNITURE
& STAMPE



Art. A004 **Ostacolo con cerniere (richiudibile)**
altezza regolabile da 10 a 60 cm.
in alluminio Ø mm. 32
 Hinged Hurdle (foldable) adjustable height
 from 10 to 60 cm. in aluminium

44,65€



40,15€

Art. P0055

**Ostacolo Telescopico graduato,
altezza regolabile
da 40 a 60 cm. in PVC**

Telescopic Hurdle - graded - height adjustable
from 40 to 60 cm. in PVC



Art. P0055



**Completamente smontabili,
minimo ingombro!**
Dismountable legs,
easy to transport

pg.5



**Montanti
graduati in cm.**
Graded in cm.

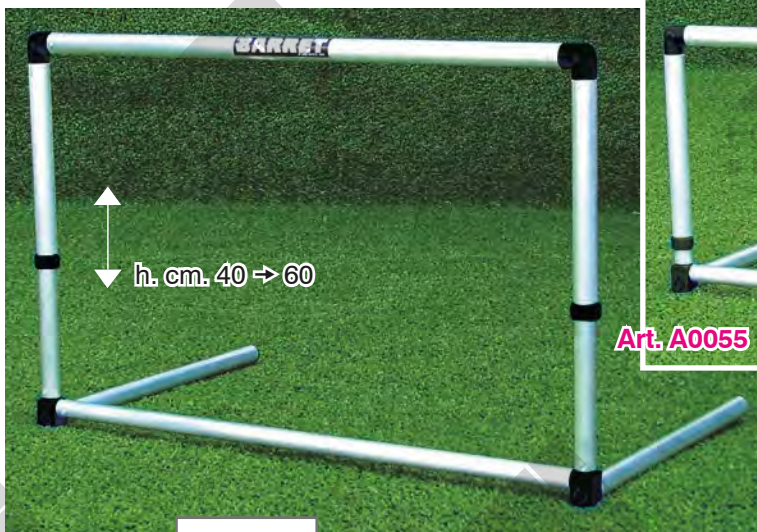

Art. A0055

56,85€

Art. A0055
**Ostacolo Telescopico graduato, altezza regolabile
da 40 a 60 cm. in alluminio**
Telescopic Hurdle - graded - height adjustable
from 40 to 60 cm. in aluminium

**Montanti graduati
in cm.**
Graded in cm.

**Completamente
smontabili,
minimo ingombro!**
Dismountable legs,
easy to transport



43,20€

Art. P005
Ostacolo Telescopico graduato,
altezza regolabile da 60 a 100 cm. in PVC
Telescopic Hurdle - graded - height adjustable
from 60 to 100 cm. in PVC

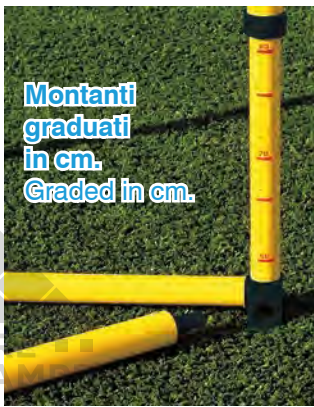
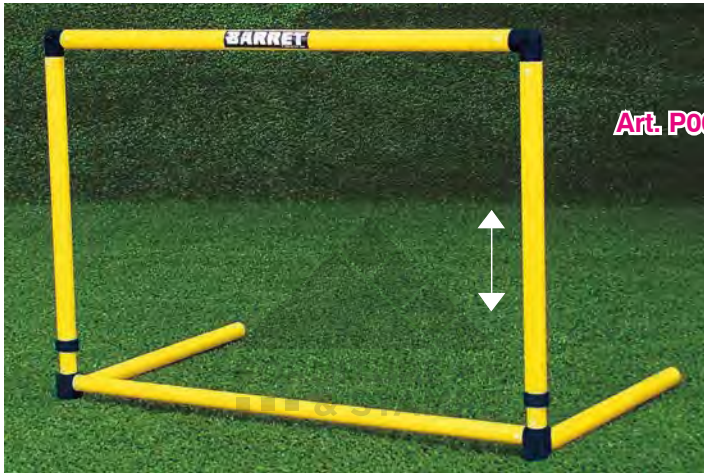

Completamente smontabili,
minimo ingombro!
Dismountable legs,
easy to transport

pg.5



62,60€

Art. A005
Ostacolo Telescopico graduato,
altezza regolabile da 60 a 100 cm. in alluminio
Telescopic Hurdle - graded
height adjustable from 60 to 100 cm. in aluminium



Completamente smontabili,
minimo ingombro!
Dismountable legs,
easy to transport

Montanti graduati in cm.
Graded in cm.



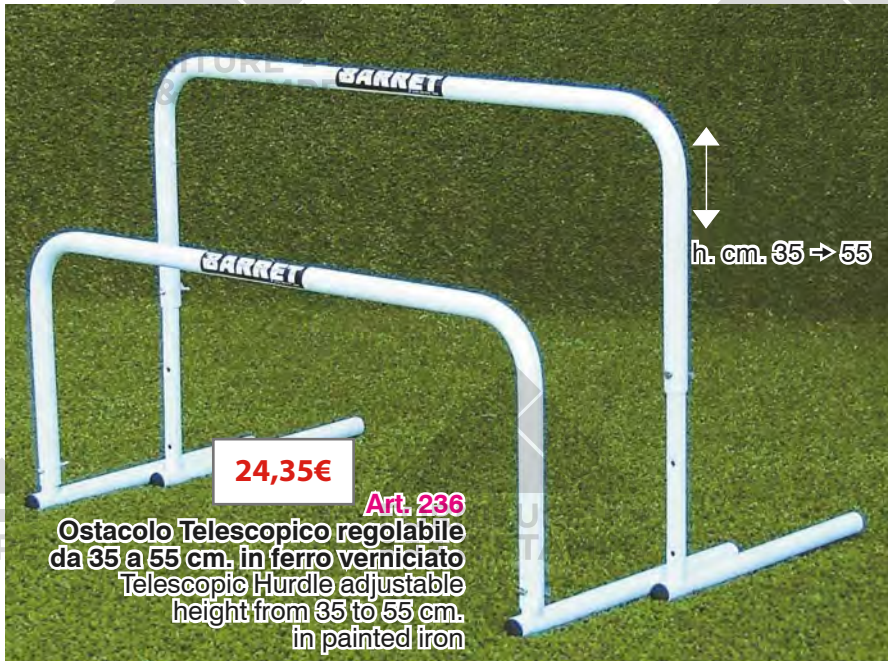

Art. H6912
Mini-Ostacolo per bambini in plastica antiurto
 larghezza traversa cm. 45
 altezza regolabile a cm. 15-23-30
 Mini-Hurdle for kids in plastic 45 cm. wide adjustable height at 15-23-30 cm.

17,05€



Art. 036
Mini-Ostacolo per bambini in plastica regolabile da 10 a 50 cm.
 Mini-Hurdle for kids in plastic adjustable height from 10 to 50 cm.

16,10€

IDEALI PER USO INDOOR E PER PALESTRE

For indoor use



**SEMPRE IN PIEDI
DOPO OGNI URTO!
THEY ALWAYS COME
BACK UP AFTER
ANY HIT!**

32,15€

30cm

36,65€

40cm

41,15€

50cm

54,10€

60cm

pg.5

Art. 5020 / 5021 / 5022 / 5023
Ostacolo Basculante in PVC Ø mm. 28
altezza fissa cm. 30 / 40 / 50 / 60
Self-Straightening Hurdle in PVC fixed height,
available in 30 / 40 / 50 / 60 cm.



pg.5

37,00€

30cm

41,90€

40cm

54,90€

50cm

62,20€

60cm

Art. A5020 / A5021 / A5022 / A5023
Ostacolo Basculante in alluminio Ø mm. 28
altezza fissa cm. 30 / 40 / 50 / 60
Self-Straightening Hurdle in aluminium
fixed height, available in 30 / 40 / 50 / 60 cm.

**SEMPRE IN PIEDI
DOPO OGNI URTO!
THEY ALWAYS COME
BACK UP AFTER
ANY HIT!**



● I numeri in giallo indicano la pagina di riferimento del listino Prezzi 2024-2025

KIT CALCIO TENNIS - Soccer Tennis Kits



95,50€

Art. 013-N
Kit Calcio Tennis pali in PVC
completo di rete mt. 3,30
tiranti e picchetti
per terreni naturali
Soccer Tennis Kit PVC poles
with 3,30 meter net
tightening ropes and pegs
for natural grass

pg.6



Art. 013.G Kit calcio tennis pali in PVC
con rete mt.10 - altezza cm.130
con tiranti, picchetti e sacca
per terreni naturali

115,00€

Soccer Tennis Kit PVC poles
10 meter long 130 cm. height net with
ropes, steel hooks and bag
for natural grass



pg.6



100,00€

Art. 013.P
Kit calcio tennis
con rete mt. 3
utilizzabile anche
su terreni sintetici
o indoor
con sacca

Soccer Tennis Kit
3 meter net - with bag
also for artificial
grass or indoor

109,15€

Art. 013.SP

Kit calcio tennis con rete cm.
450x170
utilizzabile anche
su terreni sintetici o indoor

con sacca

Soccer Tennis Kit 4,5x1,7 meter net
with bag, also for artificial grass
or indoor



pg.6

102,40€

Art. 013.60

Kit calcio tennis
con rete cm. 600x90
utilizzabile anche
su terreni sintetici
o indoor con sacca
Soccer Tennis Kit
6,0x0,9 meter net
with bag, also
for artificial grass
or indoor



Art. 013.S

Kit Calcio Tennis TATTICO
pali in polipropilene
completo di rete in PVC mt. 2,30 regolabile in
altezza, tiranti e basi in ferro verniciato
utilizzabile anche su terreni sintetici o indoor
Soccer Tennis Kit polypropylene poles
with adjustable height PVC net 2,30 meter long,
tightening ropes and painted steel bases
also for artificial grass or indoor

409,50€

**Nasconde per qualche istante la visione
del pallone, determinando risposte a livello
neuromuscolare e migliorando cinestesia e
sensibilità nel tocco di palla**

This Soccer Tennis Kit hides the ball from
player's visibility stimulating neuro muscular
reflexes and improving ball control

pg.6



Art. 013.SB

Borsa per Kit calcio tennis

Art. 013.S

Bag to carry soccer tennis
kit Art. 013.S

35,00€



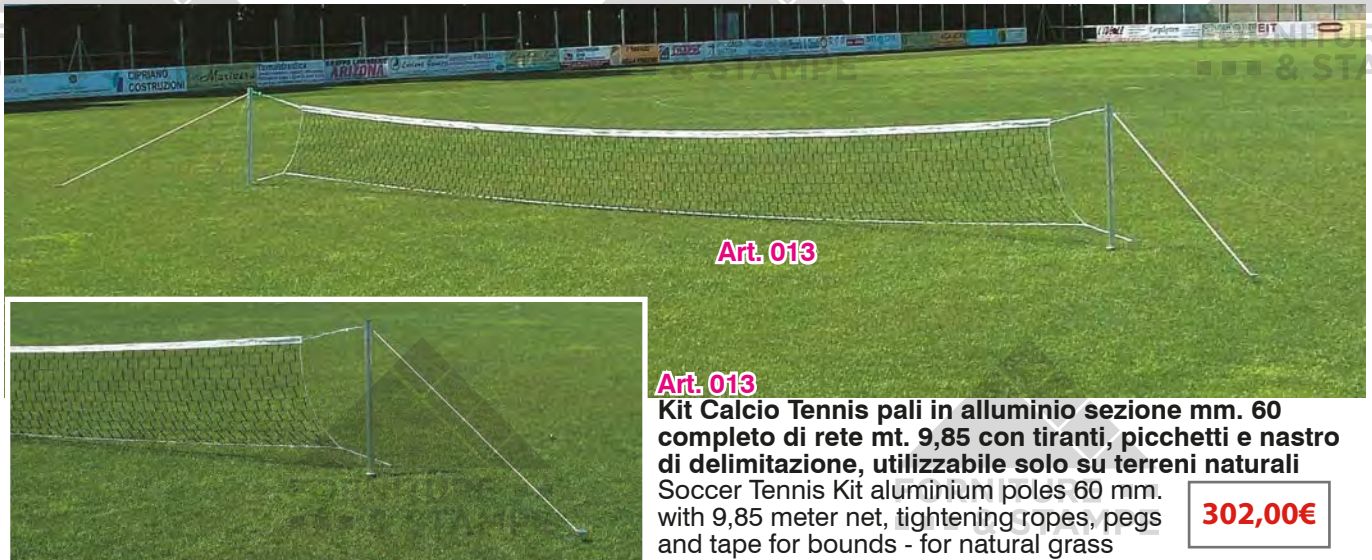

Art. 013



Art. 013

Kit Calcio Tennis pali in alluminio sezione mm. 60 completo di rete mt. 9,85 con tiranti, picchetti e nastro di delimitazione, utilizzabile solo su terreni naturali
 Soccer Tennis Kit aluminium poles 60 mm. with 9,85 meter net, tightening ropes, pegs and tape for bounds - for natural grass

302,00€

pg.6



Art. 014

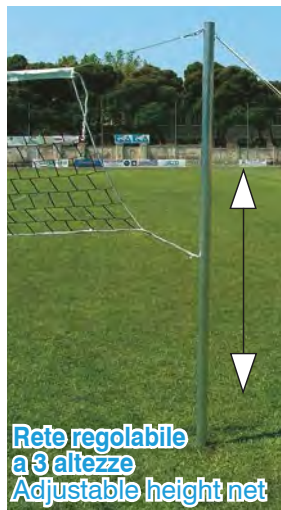

Rete regolabile a 3 altezze
Adjustable height net

Art. 014

Kit Calcio Tennis pali in alluminio sezione mm. 60 completo di rete mt. 9,85 regolabile a 3 altezze (cm. 110/170/230) con tiranti, picchetti e nastro di delimitazione, utilizzabile solo su terreni naturali
 Soccer Tennis Kit aluminium poles 60 mm. with 9,85 meter net adjustable at 3 different heights, tightening ropes, pegs and tape for bounds for natural grass

pg.6

389,00€



Art. 014

pg.30

10,70€

Art. NS200

Rotolo nastro stradale bianco/rosso mt. 200 (compreso nei kit Art. 013 e Art. 014)
 Red/White Tape length 200 meters (supplied with kit Art. 013 and Art. 014)

I numeri in giallo indicano la pagina di riferimento del Listino Prezzi 2024-2025

ARCHI DI PRECISIONE - Precision passing arcs

pg.5

FORNITURE ■ ■ ■ ■ ■

FORNITURE ■ ■ ■ ■ ■
■ ■ ■ ■ ■ STAMPE

FORNITURE ■ ■ ■ ■ ■
■ ■ ■ ■ ■ & STA



Art. AP35
Arco di precisione
in PVC tubo pieno
larghezza cm.45
Shooting/Passing Arc
in PVC - full flexible pipe
45 cm. wide

Per terreni naturali
For natural grass

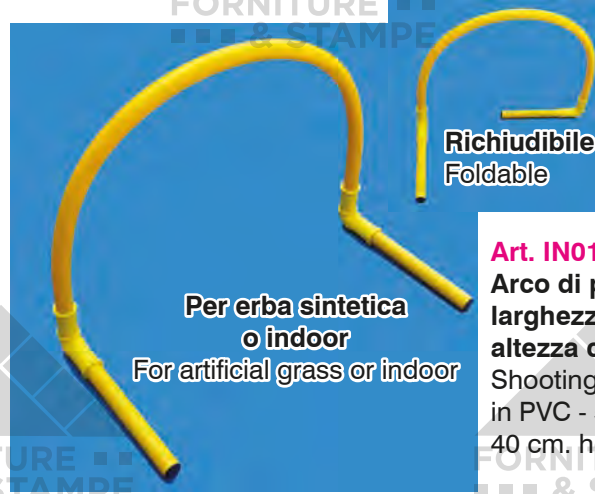

Richiudibile
Foldable

32,15€

pg.6

Art. IN01
Arco di precisione in PVC
larghezza cm.50
altezza cm.40
Shooting/Passing Arc
in PVC - 50 cm. width
40 cm. height

Per erba sintetica
o indoor
For artificial grass or indoor



Per terreni naturali
For natural grass

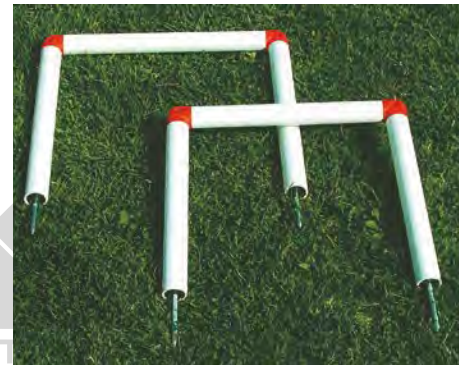

Art. 020 / 021 / 022 pg.5 pg.6
Arco di precisione in polipropilene
Ø 40 mm. cm. 45x45 / 40x40 / 35x35
Shooting/Passing Arc
in polypropylene Ø 40 mm.
dim. 45x45 / 40x40 / 35x35 cm.

33,00€



Per terreni naturali
For natural grass



32,15€

Art. A020 / A021 / A022
Arco di precisione
in alluminio Ø 32 mm.
cm. 45x45 / 40x40 / 35x35
Shooting/Passing Arc
in aluminium Ø 32 mm.
dim. 45x45 / 40x40 / 35x35 cm.

pg.6



FORCHE - Heading Trellises

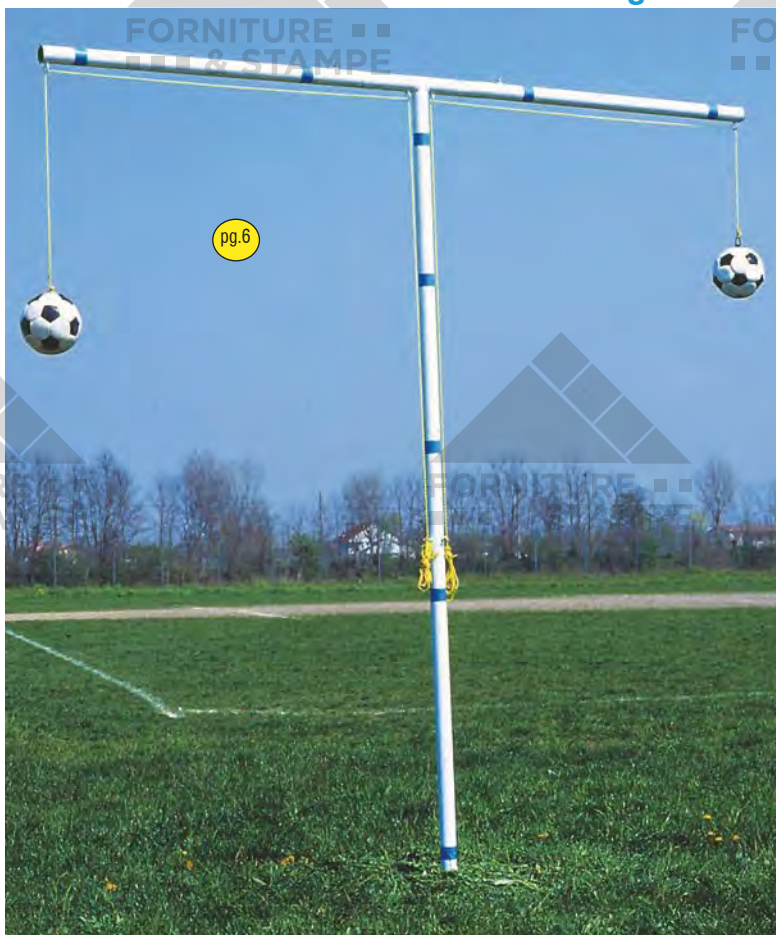

Art. F203 **303,00€**
**Forca doppia
in ferro verniciato
telescopica, smontabile
bussola inclusa
altezza da terra cm. 300
(palloni esclusi)**
Double Heading Trellis
in painted iron
telescopic, dismountable,
underground socket included,
height 300 cm. off ground
(balls not included)



641,00€

Art. FAC242

**Forca singola in acciaio
verniciato metallizzato Ø mm. 80
su base in plastica riempibile
da lt. 105 con ruote
lunghezza braccio orizzontale cm. 150
(pallone escluso)**

Single Heading Trellis in painted steel
pipe Ø 80 mm.
105 lt. plastic base on wheels
to be filled with water or sand
horizontal length 150 cm.
(ball not included)



138,00€

Art. F243

**Carrello con ruote pneumatiche per
spostamento Art. FAC242 su terreni erbosi**
Trolley with pneumatic wheels for moving
Art. FAC242 on grass



347,00€

Art. 038
Forca doppia
in alluminio
tubo sezione 60 mm.
altezza da terra cm.300
(palloni esclusi)
 Double Heading Trellis
 in aluminium
 pipe section 60 mm.
 300 cm. height off ground
 (balls not included)

17,55€

Art. B038
Bussola per forca
Art. 038 (optional)
 Underground socket
 for Art. 038 (optional)



59,50€

Art. ACTP40
Attrezzo per l'allenamento
al colpo di testa
applicabile a porte di qualsiasi tipo
per mezzo di fettucce elastiche,
in PVC Ø mm. 40
(pallone escluso)
 Header training tool
 to be easily applied to goals of any type
 by means of elastic tapes,
 PVC pipe Ø 40 mm.
 (ball not included)

pg.6



27,10€

Art. 039.4
Pallone per
forca in pelle
 sintetica
 disponibile
 mis. 4
 Ball for
 Heading Trellis,
 in synthetic
 leather
 available
 size 4



35,80€

Art. ULTVE5
Pallone per forca Trial n. 5 in gomma
 doppio strato gr. 420 Ø cm. 21,5
 Trial rubber Ball for Heading trellis
 size 5 double stratum

Art. ULTVE4
Pallone per forca Trial n. 4 in gomma
 doppio strato gr. 250 Ø cm. 20
 Trial rubber Ball for Heading trellis
 size 4 double stratum

34,10€



Con questo attrezzo
è possibile verificare
 giornalmente i
 miglioramenti
 nell'elevazione
 degli atleti
 This instrument tests
 players' daily jump
 improvements

770,00€

Art. HJT **Head Jump Tester** - strumento polivalente di misurazione ed allenamento, permette la valutazione delle qualità muscolari degli arti inferiori, dell'elevazione dei giocatori, del loro modo di colpire la palla di testa e dell'ampiezza del tuffo del portiere
 Instrument that allows the training and measurement of jump ability of players and goalkeepers



pg.10

BARRIERE SPECIALI - GK TRAINING

1295,00€

Art. 003WB
BARRIERA CON FINESTRE
 per l'allenamento ai calci di punizione e per il miglioramento dei tempi di reazione del portiere in caso di tiri improvvisi
kit completo
 WINDOW BARRIER for free kicks and Goalkeeper training to fast and sudden shots complete kit

pg.1

Art. 003WBS
STRUTTURA SUPERIORE
 barriera con finestre, applicabile al carrello porta sagome Art. 003
Window Barrier UPPER PART
 to be fixed upon trolley Art. 003

765,00€

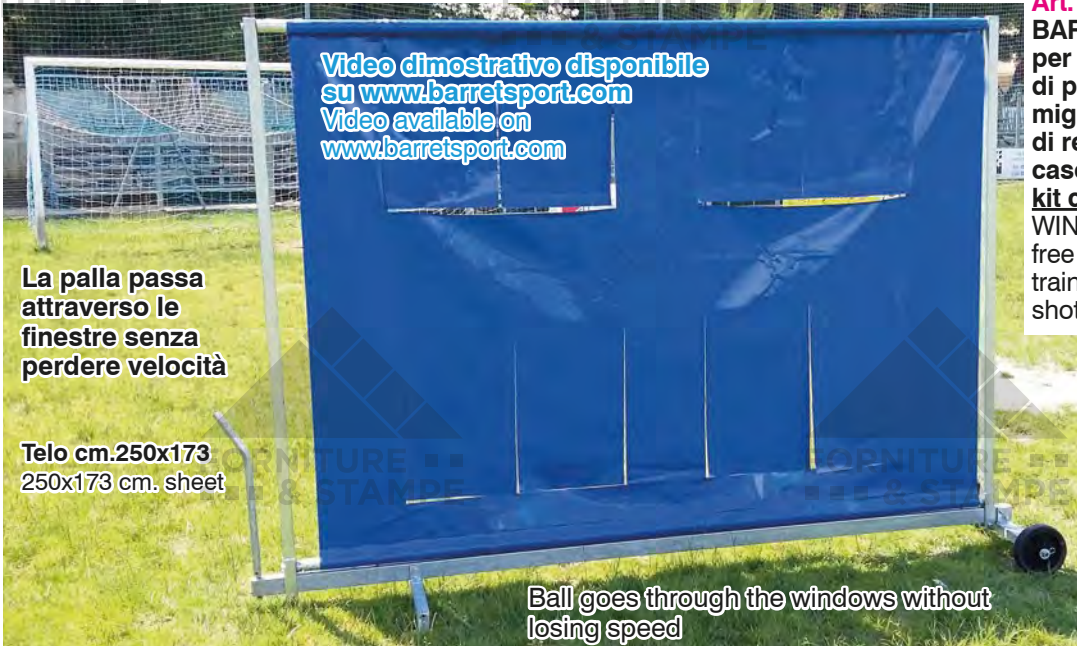

Video dimostrativo disponibile su www.barretsport.com
 Video available on www.barretsport.com

La palla passa attraverso le finestre senza perdere velocità

Telo cm.250x173
 250x173 cm. sheet

Ball goes through the windows without losing speed

Art. 003RX
BARRIERA FILTRANTE REFLEX kit completo
 REFLEX FILTERING BARRIER on wheels - complete kit

1682,00€

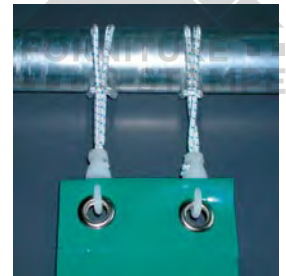

Nuovo sistema di fissaggio
 New more resistant elastics and hooks

1152,00€

Art. 003RXS
STRUTTURA SUPERIORE barriera filtrante REFLEX, applicabile al carrello porta sagome Art. 003
 Reflex Filtering Barrier UPPER PART to be fixed upon trolley Art. 003

pg.1



INNOVATIVO ATTREZZO FONDAMENTALE PER L'ALLENAMENTO DEI RIFLESSI DEL PORTIERE. LA PALLA (INVISIBILE PER IL PORTIERE AL MOMENTO DEL CALCIO) FILTRA ATTRAVERSO LE STRISCE ED ARRIVA IN PORTA ALL'IMPROVISO ASSUMENDO TALVOLTA TRAIETTORIE IMPREVEDIBILI. ATTREZZO DA POSIZIONARE IN PROSSIMITÀ DELL'AREA PICCOLA

A revolutionary device for goalkeeper's reflex training. The goalkeeper cannot see the ball until it passes through the stripes. The direction of the ball is often unpredictable! To be placed not too far from goalkeeper's area

L'ATTREZZO PUO' INOLTRE ESSERE UTILIZZATO COME UNA COMUNE BARRIERA PER L'ALLENAMENTO DEI CALCI DI PUNIZIONE

It is also very useful for free kick practising for both kicker and goalkeeper!



MURI - TELAI CON RETE - Rebounders - Iron frames with net



Video dimostrativo
disponibile
su www.barretsport.com
Video available on
www.barretsport.com

Art. 5011

Muro per allenamento portieri in vetroresina
montato su telaio con 4 ruote

Fiberglass Goalkeeper Rebounder
mounted on frame with
4 wheels

2242,00€

pg.6

Dimensioni:
altezza cm.200
larghezza cm.130
profondità cm.80
peso Kg.100

Dimensions:
height 200 cm.
width 130 cm.
depth 80 cm.
weight 100 Kg.

Calciando o lanciando la palla
verso il muro, essa assumerà
traiettorie di rimbalzo
imprevedibili favorendo
l'allenamento dei riflessi
del portiere

By kicking or throwing the ball
against the wall it will rebound in
different directions,
testing and training GK's reflexes



Zavorra
in cemento
inclusa
Concrete
ballast
included

Consente l'allenamento con
o senza il preparatore atletico
Goalkeeper can exercise
by himself as well



Con superficie superiore a semisfere
e superficie inferiore piana
Upper side with hemispheres
and flat lower side



2184,00€

Art. 5012SC
Muro per allenamento portieri in vetroresina cm. 200x130 installato su carrello in acciaio zincato con ruote Art. NCP3S
 Fiberglass Goalkeeper rebounder 200x130 cm. installed on a galvanized steel trolley with wheels Art. NCP3S

pg.6



Art. KMC3S
Kit superiore muro allenamento portieri per adattamento a carrello Art. NCP3S oppure Art. 003
 Rebounder kit upper part to be fixed upon trolley Art. NCP3S or Art. 003

1675,00€

pg.6

Rimuovendo il pannello in vetroresina ed eventualmente il telaio di sostegno, si può utilizzare il carrello porta 3 sagome Art. NCP3S
 By removing the fiberglass panel and the support frame, you can use the trolley for carrying 3 mannequins Art. NCP3S



1283,00€

Art. PVLSC
Pannello in vetroresina con superficie superiore a semisfere e superficie inferiore liscia, munito di ganci e staffa per ancoraggio - dimensioni cm. 200x130
Può essere acquistato separatamente ed installato facilmente sulla Barriera Filtrante Reflex Art. 003RX oppure sulla Barriera con Finestre Art. 003WB
 Fiberglass panel with upper hemisphere surface and lower smooth surface, equipped with hooks and anchor bracket - size 200x130 cm. It can be purchased separately and easily installed both on the Reflex Filtering Barrier Art. 003RX and on the Window Barrier Art. 003WB





Dimensioni:
m. 1,3 larghezza x m. 1,1 altezza
ciascuna faccia
peso Kg. 50
Dimensions:
1,3 m. width x 1,1 m. height
every side
weight 50 Kg.

● pg.6

2304,00€

Art. R1150

Muro per allenamento giocatori e portieri a 2 facce di cui una piana ad inclinazione regolabile ed una con emisfere, interamente in vetroresina montato su telaio con 4 ruote
2 side Fiberglass Players and Goalkeepers' Rebounder mounted on frame with 4 wheels
the flat side can be inclined, the fixed side with hemispheres



Attraverso l'utilizzo della parete ad inclinazione regolabile è possibile determinare traiettorie di risposta della palla verso l'alto al fine di sollecitare il tiro al volo, il colpo di testa ed il controllo di palla
Calciando o lanciando la palla verso la parete con emisfere, essa assumerà traiettorie di rimbalzo imprevedibili favorendo l'allenamento dei riflessi del portiere e dei giocatori
Thanks to the adjustable inclination of the flat side you can get an upward ball rebound and train acrobatic shooting, headers and ball control
Through the use of the side with hemispheres you can get unpredictable trajectories for training goalkeepers' reflexes and players' reactivity



2304,00€

Art. 5050

Muro per allenamento giocatori a 2 facce di cui una ad inclinazione regolabile, interamente in vetroresina montato su telaio con 4 ruote
 2 side Fiberglass Players' Rebounder mounted on frame with 4 wheels
 one side can be inclined

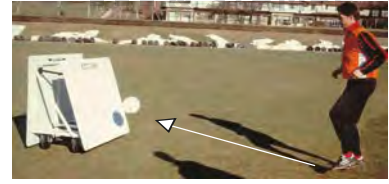

Kg. 50



Dimensioni:
 m. 1,3 larghezza x m. 1,1 altezza
 ciascuna faccia
peso Kg. 50
 Dimensions:
 1,3 m. width x 1,1 m. height
 every side
 weight 50 Kg.

Attraverso l'utilizzo della parete ad inclinazione regolabile è possibile determinare traiettorie di risposta della palla verso l'alto al fine di sollecitare il tiro al volo, il colpo di testa ed il controllo di palla
 Thanks to the adjustable inclination you can get an upward ball rebound and train acrobatic shooting, headers and ball control



Kg. 50



2250,00€

Art. 5010

Muro per allenamento giocatori a 3 facce in vetroresina montato su telaio con 3 ruote
 3 side Fiberglass Players' Rebounder mounted on frame with 3 wheels
 Dimensions: 1,3 m. width x 1,1 m. height
 every side
 weight 50 Kg.





1814,00€

Art. MP501N

Muro prismatico in vetroresina a 3 facce piane di dimensioni cm.107x140 - cm.107x120 - cm.107x108 - peso Kg.48 - con asole per il trasporto
****utilizzabile contemporaneamente da 2 lati ed in 4 diverse posizioni****

3 side Fiberglass Players' Rebounder with side dimensions 107x140 cm. - 107x120 cm. - 107x108 cm. weight 48 Kg. with slots for transport
****allows 4 different training positions on both sides simultaneously****

pg.7



Permette di ottenere la più ampia varietà di rimbalzi e traiettorie, utili per il miglioramento del controllo di palla, del passaggio, del tiro al volo e del colpo di testa

1

Posizione "in piedi" con 3 facce perpendicolari al terreno di gioco
Standing position with all sides perpendicular to the ground



2

Posizione con base a terra cm.107x108
Allenamento con superfici di rimbalzo ad inclinazione alta e medio-alta
Position with 107x108 cm. base
Training with high and medium inclination rebounding sides

Allows the widest variety of rebounds in order to improve ball control, passing and shooting

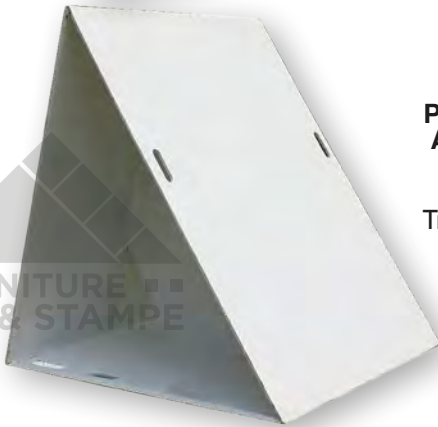

3

Posizione con base a terra cm.107x120
Allenamento con superfici di rimbalzo ad inclinazione alta e bassa
Position with 107x120 cm. base
Training with high and low inclination rebounding sides



4

Posizione con base a terra cm.107x140
Allenamento con superfici di rimbalzo ad inclinazione medio-bassa e bassa
Position with 107x140 cm. base
Training with medium-low and low inclination rebounding sides

Rinforzo interno per l'ottimizzazione del rimbalzo
Internal reinforcement for rebound improvement

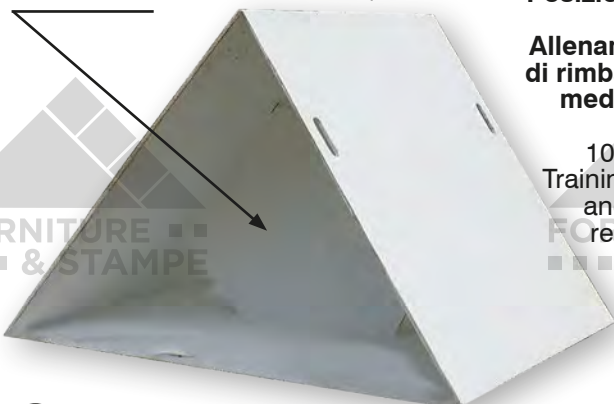

Art. PLRB16

Muro prismatico PROFESSIONALE
in vetroresina a 3 facce piane
larghezza cm.130 - altezza massima cm.65
con asole per il trasporto - peso kg.18
****utilizzabile contemporaneamente da 2 lati**
ed in 3 diverse posizioni**

PROFESSIONAL 3 side Fiberglass Players' Rebounder width 130 cm. - maximum height 65 cm. with slots for transport - 18 kg. weight
****allows 3 different training positions on both sides simultaneously****

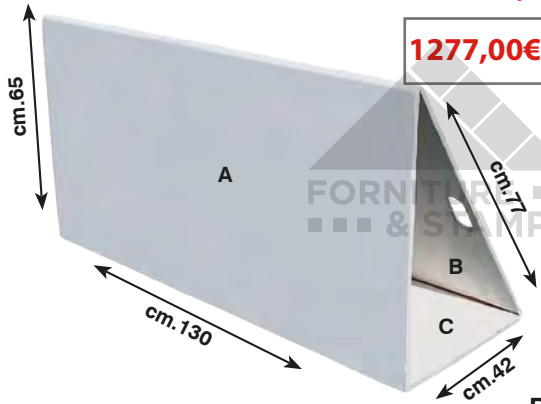

1
Posizione con superficie A perpendicolare al terreno e superficie B molto inclinata
 Position with 90 degrees A side and high inclination B side

Art. PLRB23

Muro prismatico in legno multistrato marino
a 3 facce piane larghezza cm.122
altezza massima cm.65
con asole per il trasporto - peso kg.20
****utilizzabile contemporaneamente da 2 lati**
ed in 3 diverse posizioni**

3 side marine plywood Players' Rebounder width 122 cm. - maximum height 65 cm. with slots for transport - 20 kg. weight
****allows 3 different training positions on both sides simultaneously****



Video dimostrativo disponibile su www.barretsport.com
 Video available on www.barretsport.com

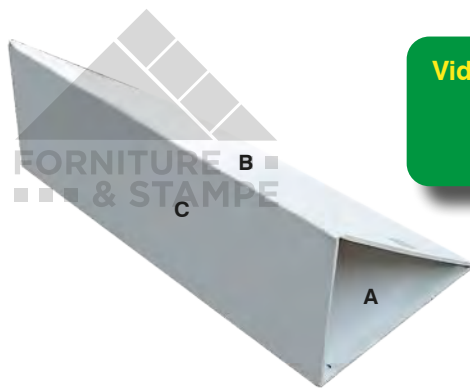

2
Posizione con superficie C perpendicolare al terreno e superficie B inclinata
 Position with 90 degrees C side and low inclination B side

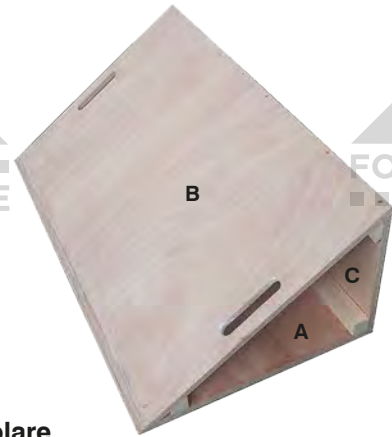

Prodotto professionale in vetroresina con rinforzo interno per l'ottimizzazione del rimbalzo
 Professional in fiberglass with internal reinforcement for rebound improvement

Si consiglia di utilizzare una zavorra all'interno dell'attrezzo per conferire maggiore stabilità
 It is recommended to place a weight inside for great stability

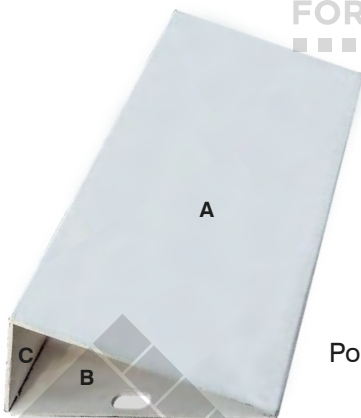

3
Posizione con superfici A e C a diverse inclinazioni
 Position with A and C sides differently inclined

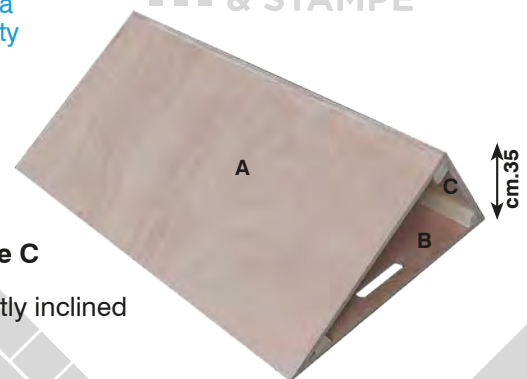

Permettono di ottenere la più ampia varietà di rimbalzi e traiettorie, utili per il miglioramento del controllo di palla, del passaggio, del tiro al volo e del colpo di testa

They allow the widest variety of rebounds in order to improve ball control, passing and shooting

● I numeri in giallo indicano la pagina di riferimento del Listino Prezzi 2024-2025

953,00€

Art. PAR180

PLANCHE À REBONDS

Parete rimbalzante realizzata in PE (all'esterno) e PU (all'interno)

ideale per l'effettuazione di esercizi individuali e di gruppo volti al miglioramento della coordinazione motoria, del controllo di palla, del passaggio e del tiro

Rebound board made of PE (outside) and PU (inside)

very useful for individual and group exercises aimed to improve coordination, ball control, passing and shooting

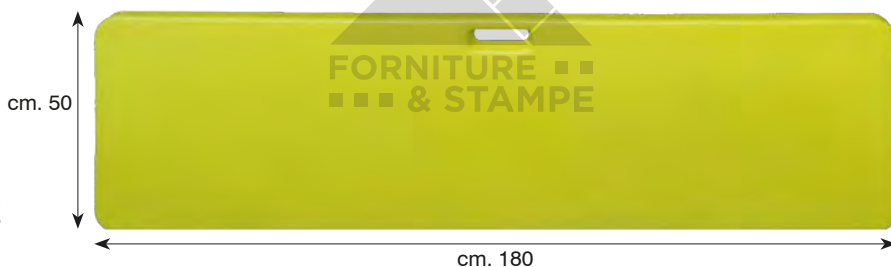

**Dimensioni: lunghezza cm. 180
altezza cm. 50
profondità cm. 34
peso kg. 23**

**Dimensions: length 180 cm.
height 50 cm.
depth 34 cm.
weight 23 kg.**

pg.7

La distribuzione dei volumi appesantiti consente ottima stabilità e perfetto bilanciamento anche negli impatti più potenti. Tuttavia, se lo si ritiene necessario, è possibile aggiungere peso mediante sabbia o acqua
The distribution of the weighted volumes allows excellent stability and perfect balance even with the most powerful shots. However, if necessary, sand or water can be added



pg.7

Art. TM001

Muro triangolare in legno multistrato marino, trattato con vernice impermeabilizzante

dimensioni lato cm.150x50
Attraverso l'uso in posizione verticale è possibile determinare traiettorie di risposta della palla verso l'alto al fine di sollecitare il tiro a volo, il colpo di testa e lo stop (ad esaurimento)

Triangular rebounder made of marine plywood treated with special paint against humidity - side size 150x50 cm.

By placing it in vertical position you will receive an upward ball rebound to train acrobatic shooting, header and ball control (until available)

1130,00€



pg.7

173,00€

Art. PTI.503

Telaio con rete in acciaio verniciato, bifacciale ricurvo su un lato - inclinazione regolabile dim. cm. 111x105x63
2 face adjustable inclination iron frame with net for goalkeepers and players size 111x105x63 cm.

● Numbers in yellow show the relevant page on 2024-2025 Price List



261,00€

Art. SCVR16

Disco in vetroresina con maniglie per l'allenamento della reattività del portiere sulle deviazioni da tiro o colpo di testa ravvicinato diametro cm.47 peso kg.2

Fiberglass Discus with handles

for close shot and deflection GK training - diameter 47 cm. weight 2 kg.

pg.7



185,00€

Art. 5030.T

Telaio con rete in alluminio dim. cm.90x70 ad inclinazione regolabile con maniglie impugnabili dal preparatore.

Consente la simulazione di colpi di testa e tiri acrobatici per un allenamento alternativo del portiere

Aluminium frame with net size 90x70 cm. adjustable inclination with handles for trainer to simulate headers and acrobatic shooting trajectories for new GK exercises



FORNITURE ■ ■ ■ ■ & STAMPE

FORNITURE ■ ■ ■ ■ & STAMPE

FORNITURE ■ ■ ■ ■ & STAMPE

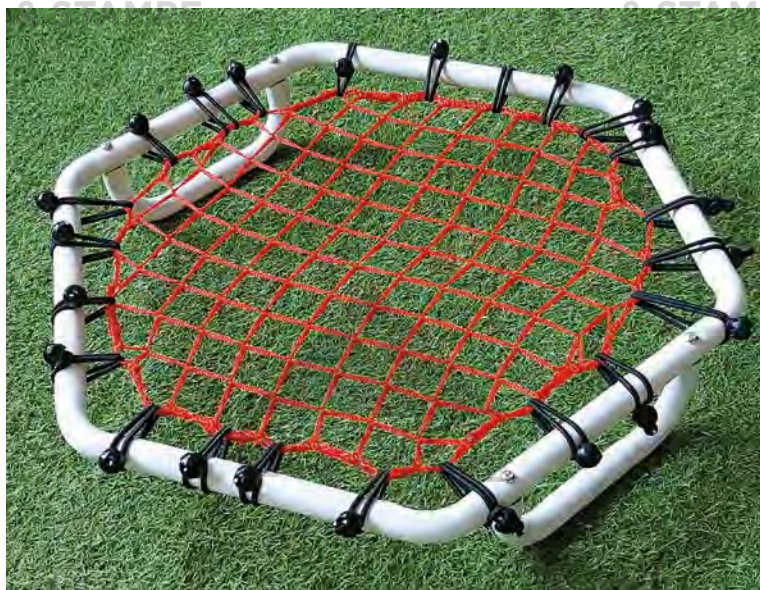

66,30€

pg.7

Art. PTI.5858

Telaio con rete esagonale in metallo verniciato dim. cm.65x58 con maniglie impugnabili dal preparatore.

Consente la simulazione di colpi di testa e tiri acrobatici per un allenamento alternativo del portiere

Hexagonal metal frame with net size 65x58 cm. with handles for trainer to simulate headers and acrobatic shooting trajectories for new GK exercises



con picchetti di ancoraggio with anchoring hooks

kg-7

134,50€

Art. 5030

Telaio con rete cm. 130 x 130 in ferro verniciato ad inclinazione regolabile
Painted iron frame with net, dimensions 130 x 130 cm. adjustable inclination

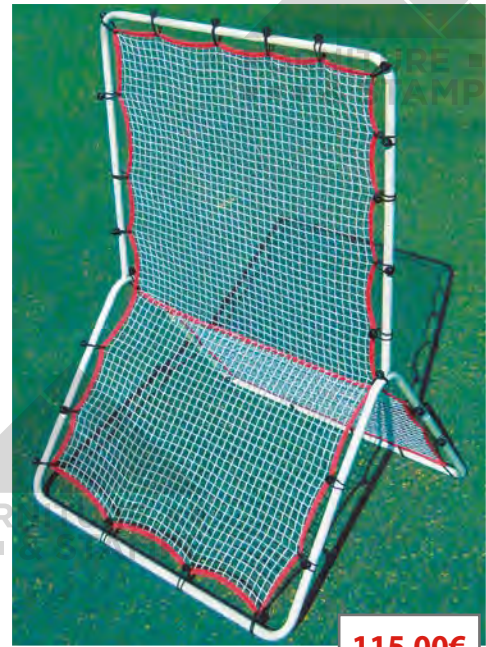

115,00€

Art. 503.BF

Telaio con rete in ferro verniciato, bifacciale a doppia inclinazione, altezza cm.150 larghezza cm.100 con picchetti per fissaggio a terra, per allenamento portieri e giocatori
Iron frame with net, in painted iron 2 sides double inclination height 150 cm. width 100 cm. with anchoring hooks for goalkeepers and players

pg.7

Art. 5035G Telaio con rete cm.105 x 105 in ferro cromato ad inclinazione regolabile, per allenamento portieri e giocatori
Iron frame with net in chromed iron dimensions 105 x 105 cm. adjustable inclination for goalkeepers and players

444,50€

Prodotto professionale in ferro cromato
Professional in chromed iron

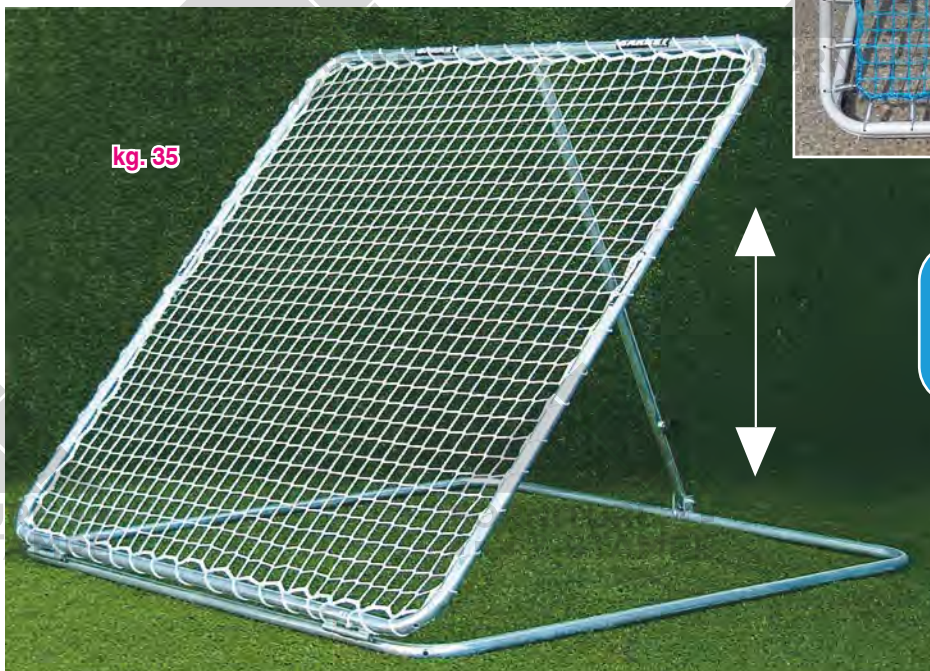

kg. 35

Prodotto professionale in ferro zincato
Professional in galvanized iron

675,00€

Art. 5040

Telaio con rete cm. 140 x 140 in ferro zincato ad inclinazione regolabile, per allenamento portieri e giocatori
Iron frame with net in galvanized iron dimensions 140 x 140 cm. adjustable inclination for goalkeepers and players

FORNITURE
& STAMPE



1260,00€

Art. 50.220
Telaio con rete
cm. 220 x 180
in ferro zincato
ad inclinazione regolabile,
per allenamento
portieri e giocatori
Iron frame with net in
galvanized iron dimensions
220 x 180 cm.
adjustable inclination
for goalkeepers and players



446,00€

Art. ST221
Set 4 ruote con staffa per un
agevole trasporto del telaio
Art. 50.220 (optional)
Set of 4 wheels with bracket
for Art. 50.220 (optional)

Prodotti professionali
in ferro zincato
Professional in
galvanized iron

pg.7

FORNITURE
& S



2320,00€

Art. 5041
Telaio con rete **cm. 315 x 230**
in ferro zincato ad inclinazione regolabile,
per allenamento portieri e giocatori
Iron frame with net, in galvanized iron
dimensions 315 x 230 cm.
adjustable inclination
for goalkeepers and players

kg. 75

FORNITURE
& STAMPE



446,00€

Art. ST441
Set 4 ruote con staffa per un agevole
trasporto del telaio **Art. 5041 (optional)**
Set of 4 wheels with bracket for Art. 5041 (optional)





Video dimostrativo disponibile su www.barretsport.com
 Video available on www.barretsport.com

2125,00€

Art. DT01
Deviatore di traiettoria
 Tubi in alluminio, con cerniere e piedini di stabilità.
 Coadiuvano l'allenamento quotidiano del portiere ed il suo eventuale recupero post traumatico
BREVETTATO
 SHOT DEVIATOR - pipes in aluminium, with hinges and stability pegs - very useful to improve GK reactivity and to accelerate injury recovery
PATENTED

Brevettato Patented

pg.6

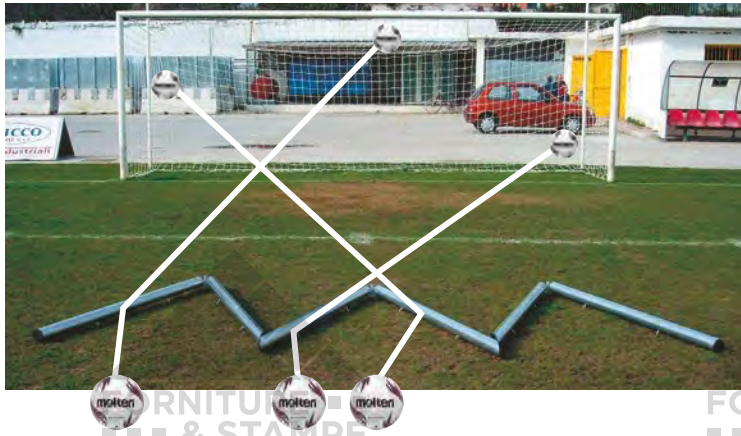

Borsa per il trasporto inclusa
 Bag included

Si consiglia di inumidire l'erba di fronte all'attrezzo per incrementare la velocità della palla calciata rasoterra prima dell'impatto con il Deviatore
 We recommend to wet the grass in front of the training device in order to let the ball hit the deviator at a higher speed



817,00€

Art. BP63
BALL PLAYNING Modello Mundial - telo in PVC con rilievi gonfiabili e riempiibili con acqua per l'allenamento dei riflessi del portiere, metri 6x2,5 completo di borsa, pompa per la gonfiatura e sacca per il trasporto dell'acqua
 Ball Playning Mundial for GK training in PVC size 6x2,5 meters with air and water bubbles, complete with pump and bag

pg.6

Video dimostrativo disponibile su www.barretsport.com
 Video available on www.barretsport.com



Bagna il Ball Playning prima dell'uso per incrementare la velocità della palla!
 Always wet your Ball Playning to increase ball speed!



I numeri in giallo indicano la pagina di riferimento del listino Prezzi 2024-2025

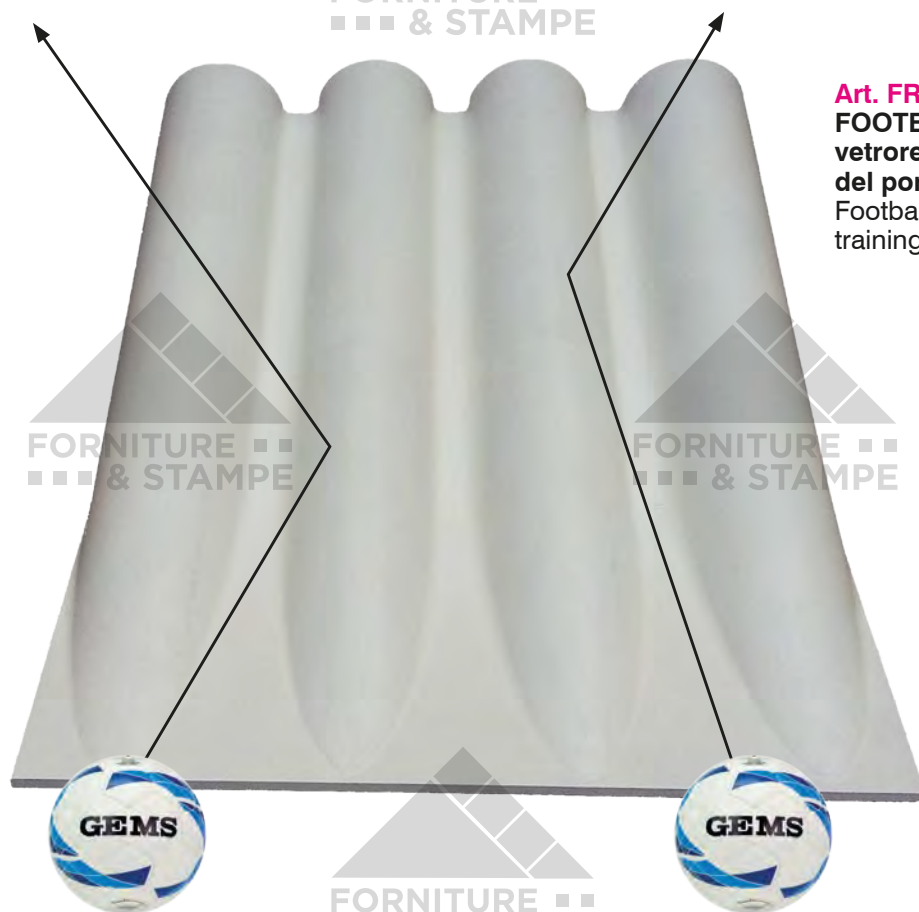

1296,00€

Art. FRM16
FOOTBALL RAMP - attrezzo in vetroresina per l'allenamento dei riflessi del portiere sui tiri ravvicinati e deviati
Football Ramp - fiberglass deviator for GK training to close highly deflected shots

Bagna il Football Ramp prima dell'uso per incrementare la velocità della palla!

Always wet your Football Ramp to increase ball speed!

pg.7

dimensioni: cm.150x110 ad inclinazione regolabile per mezzo di due piedi telescopici
dimensions: 150x110 cm. adjustable inclination by means of two telescopic feet



Video dimostrativo disponibile su www.barretsport.com
Video available on www.barretsport.com

pg.6

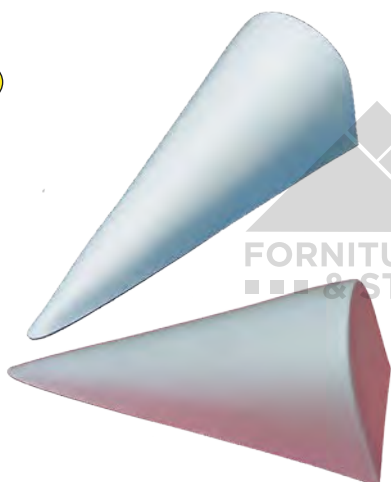

Art. BDV15
Cuspide in vetroresina appesantita con cemento, dimensioni cm.56x21x21h per allenamento dei riflessi del portiere
Fiberglass cusp with concrete filling dimensions 56x21x21 cm. for GK training

116,80€

Posizionando una serie di cuspidi nell'area piccola si ottengono deviazioni della palla improvvise, utili per l'allenamento dei riflessi e della reattività del portiere
Train goalkeeper's reactivity to sudden and close deflections by placing a number of cusps near the GK's area



212,50€

Art. FRA
FOOTBALL RACK - attrezzo in ferro zincato per l'allenamento dei riflessi del portiere sui tiri ravvicinati e deviati
dimensioni cm.160x54 - peso kg. 13
Football Rack - galvanized iron deviator for training of GK reflexes on close and deflected shots
size 160x54 cm. - weight 13 kg.

Video dimostrativo disponibile su www.barretsport.com
Video available on www.barretsport.com

pg.7



288,60€

Art. FW18

FOOTBALL WAVE - attrezzo in policarbonato per l'allenamento dei riflessi del portiere sui tiri ravvicinati e deviati
dimensioni cm. 90x60 - peso kg. 5
Football Wave - polycarbonate deviator for training of GK reflexes on close and deflected shots
size 90x60 cm. - weight 5 kg.

Bagna il Football Wave prima dell'uso per incrementare la velocità della palla!
Always wet your Football Wave to increase ball speed!

Inclinazione regolabile per mezzo di due piedi telescopici
Adjustable inclination by means of two telescopic feet

Più Football Waves possono essere posizionati contemporaneamente sul terreno per ottenere effetti imprevedibili
You can place more than one Football Wave on the pitch to get unpredictable deflections



PROPRIOCEZIONE - Equilibrium training



26,70€

Art. 168PC
Tavoletta propriocettiva in plastica su emisfera, Ø cm. 41 regolabile in altezza
 Plastic Equilibrium Board with hemisphere bottom side Ø 41 cm. adjustable height



Art. 168PC

Art. 168PC



Art. 167-L



Art. 167-L Tavoletta propriocettiva in legno su emisfera, base di appoggio cm. 30x30

Wooden Equilibrium Board with hemisphere bottom side, base 30x30 cm.

97,30€

pg.7



Art. IS441
Tavoletta propriocettiva in legno su emisfera, con rivestimento antiscivolo Ø cm. 40
 Wooden Equilibrium Board with hemisphere bottom side, Ø 40 cm. base with anti-skid surface

29,25€

Art. IS441

Tavoletta propriocettiva in legno su emisfera, con rivestimento antiscivolo Ø cm. 40
 Wooden Equilibrium Board with hemisphere bottom side, Ø 40 cm. base with anti-skid surface



Art. 169-R

97,30€

Art. 169-R Tavoletta propriocettiva in legno su semiluna, base di appoggio cm.60x40 con rivestimento in gomma antiscivolo

Wooden Equilibrium Board, with half moon bottom side, base dimensions cm.60x40 with anti-skid surface

pg.7

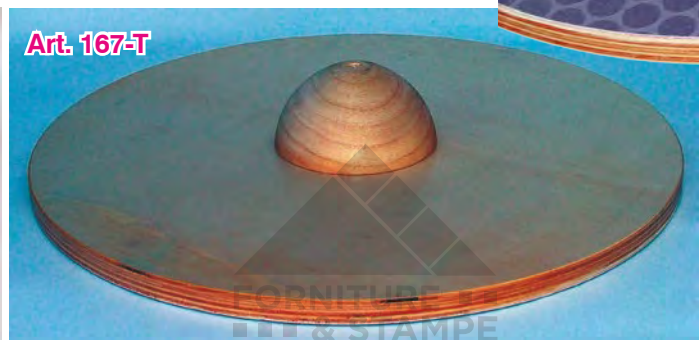

Art. 167-T

Art. 167-T Tavoletta propriocettiva in legno su emisfera, Ø base di appoggio cm. 60 con rivestimento in gomma antiscivolo

Wooden Equilibrium Board with hemisphere bottom side, base Ø 60 cm. with anti-skid surface

251,00€



273,00€

Art. 169-V Tavoletta propriocettiva in vetroresina su semiluna, base di appoggio cm.60x40

Fiberglass Equilibrium Board, with half moon bottom side, base dimensions 60x40 cm.



Art. 167-V Tavoletta propriocettiva in vetroresina su emisfera, Ø base di appoggio cm. 50

Fiberglass Equilibrium Board with hemisphere bottom side, base Ø 50 cm.

273,00€

● I numeri in giallo indicano la pagina di riferimento del Listino Prezzi 2024-2025

25,40€

9cm

28,25€

16cm



Art. MH9T / MH16T Semisfera gonfiabile Trial per riabilitazione e stimolazione propriocettiva diam. cm. 9 o cm. 16
Inflatable hemisphere for rehabilitation Ø 9 or 16 cm.

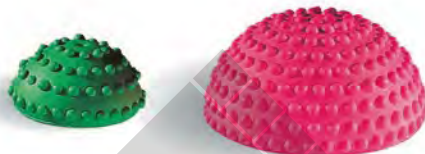

Art. FTN-DB
Cuscino gonfiabile puntinato Ø cm 32,5
Inflatable cylinder for rehabilitation Ø 32,5 cm.

38,80€



Art. FY8911
Cuscino gonfiabile puntinato Ø cm 39
Inflatable cylinder for rehabilitation Ø 39 cm.

52,15€



Special Price

76,50€

Art. C1
Pedana Cilindrica gonfiabile Trial Skimmy per riabilitazione e stimolazione propriocettiva dim. cm.32,5x6
Inflatable cylinder for rehabilitation dim. 32,5x6 cm.

pg.8



Special Price

99,15€

Art. C2
Pedana Cilindrica gonfiabile Trial Super Skimmy per riabilitazione e stimolazione propriocettiva, dim. cm.40x9
Inflatable cylinder for rehabilitation dim. 40x9 cm.



Resistenti ai tacchetti
Stud proof

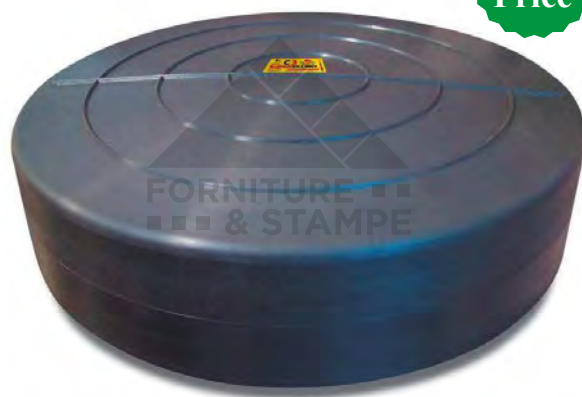

Special Price

113,65€

Art. C3
Pedana Trial Super Skimmy Professional con spalla rinforzata per riabilitazione e stimolazione propriocettiva, gonfiabile cm.40x9
Inflatable cylinder 40x9 cm. reinforced on sides



● Numbers in yellow show the relevant page on 2024-2025 Price List

210,00€



Art. C11
Pedana Rotante 1
 dim. cm 32,5x6
 kg 2,8
 (inclusa pompetta
 per la gonfiatura)
 Rotatory disk 1
 pump included



276,40€



Art. C22
Pedana Rotante 2
 dim. cm 40x10
 kg 4
 (inclusa pompetta
 per la gonfiatura)
 Rotatory disk 2
 pump included



Le Pedane Rotanti Trial, grazie al particolare meccanismo rotante, consentono di creare un'infinita varietà di esercizi basati su diverse posizioni di appoggio e modalità di movimento, utili a stimolare contemporaneamente il sistema vestibolare e quello visivo sensoriale, agendo quindi su tutti i sistemi di controllo del movimento sia a livello nervoso centrale che su quello spinale medio e periferico

Rotatory Proprioceptive Disks Trial, given the particular rotating mechanism, allow a great variety of exercises based on different positions and motions, useful to simultaneously stimulate the vestibular and the sensory visual systems at both central and spinal/peripheral nervous levels

pg.8

Art. C4
Rebound Disk - diametro cm.40
altezza cm.4 - Kg.1,5 colore rosso
 40 cm. diameter - 4 cm. thick - 1,5 Kg.

Special Price

50,15€

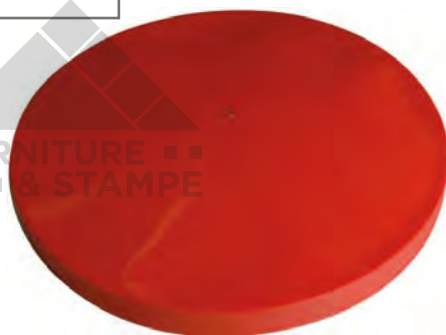

Rebound Disk Trial è una nuova pedana ideale per allenare contemporaneamente la forza muscolare e la propriocezione. È adatta sia all'uso indoor che outdoor, anche con scarpe tecniche munite di tacchetti. In particolare, con Rebound Disk è possibile sfruttare l'altezza per effettuare esercizi combinati pliometrici (cadute ed ammortizzamento con e senza rimbalzo) e propriocettivi, consentendo all'utente un'esperienza coordinativa e di potenziamento neuromuscolare notevole. Il salto, così come la corsa, è un elemento fondamentale in moltissimi sport come calcio, pallamano, beach-handball, basket, volley, e Rebound Disk è particolarmente allenante per il salto con arresto e cambio di direzione

Rebound Disk Trial is a new tool ideal to simultaneously train muscle strength and proprioception. It's suitable both for indoor and outdoor utilization, even with technical shoes (with studs). In particular, with Rebound Disk it's possible to exploit one's height for plyometric exercises (fall and dampen with or without rebound) and for proprioceptive ones, and the user is enabled to experience a remarkable coordination and neuromuscular strengthening. Jumping, as well as running, is a basic element in many sports such as soccer, handball, beach-handball, basketball, volleyball, and Rebound Disk is very effective in training jump with stop and direction changes

143,40€

**Art. T1 Medusa Trial - struttura instabile base Ø cm. 45
altezza cm. 23 per riabilitazione e stimolazione
dell'equilibrio, in gomma doppio strato
massima instabilità**

Medusa for rehabilitation
and equilibrium training
double stratum rubber
base Ø 45 cm.
height 23 cm.

Resistente
ai tacchetti
Stud proof

pg.8



Special
Price

Resistente ai
tacchetti
Stud proof

185,75€

Art. T1.1

**Medusa Trial
base Ø cm.45
altezza cm. 23
con piatto rigido
sul fondo**

**per conferire
maggiore stabilità**

Medusa base Ø 45 cm.
height 23 cm.

with rigid bottom for better
stability

pg.8



FORNITURE ■ ■ ■
& STAMPE

FORNITURE ■ ■ ■
& STAMPE

FORNITURE ■ ■ ■
& STAMPE

Special
Price

pg.8

244,00€

Art. T3

**Pedana instabile
con base inferiore
antiscivolo Ø cm. 55
altezza cm. 15**

**studiata per campi sintetici,
specificata per i più giovani**

Unstable Medusa with
anti-skid bottom

base Ø 55 cm.
height 15 cm.

ideal for artificial grass
and young players

Resistente ai
tacchetti
Stud proof



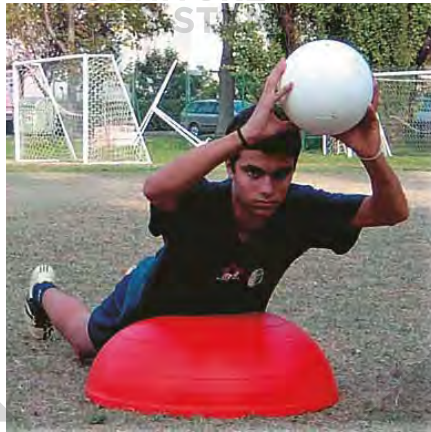

pg.8

& STAMPE

& STAMPE

& STAMPE

Resistente ai tachetti
Stud proof

Special Price

New!



Art. T2 Tartaruga Evo Trial - struttura instabile base Ø cm. 65 altezza cm. 24 per riabilitazione e stimolazione dell'equilibrio, in gomma doppio strato

Tartaruga Evo double stratum rubber base Ø 65 cm. height 24 cm. for rehabilitation and equilibrium training

337,30€



163,40€

Art. AHF-170
Pedana BOSU Ø cm.63 - h. cm.22
ideale per fitness, yoga, pilates
Bosu ball Ø 63 cm. - h. 22 cm.
ideal for fitness, yoga, pilates

Art. BOS
Pedana BOSU Ø cm.59 - h. cm.26
ideale per fitness, yoga, pilates
completa di pompa
Bosu ball Ø 59 cm. - h. 26 cm.
ideal for fitness, yoga, pilates
with pump

154,00€

pg.8





pg.7

95,50€

Art. 995212 SOMBRERO

Tavoletta per ginnastica e riabilitazione che combina l'instabilità dell'imbottitura in gommapiuma sul piano di appoggio in legno con le proprietà di una semisfera gonfiabile (ad esaurimento scorte)

Wooden Equilibrium Board with foam rubber on top and inflatable hemisphere on bottom side (until available in stock)



116,00€

Art. 995243 ROLA BOLA

Tavola per l'allenamento dell'equilibrio con superficie antiscivolo - i fermi di sicurezza impediscono al cilindro di scivolare all'esterno
Wooden Equilibrium Board with anti-skid on top
The cylinder never slips out of the board thanks to the security wood pieces on bottom side



116,80€

Art. 14181

Fettuccia con lunghezza 18 metri per l'allenamento dell'equilibrio. Si fissa facilmente tra due alberi ed è perfetta per giocare, allenarsi o fare riabilitazione. Kit completo con sacca e paraalberi
18 meter long tape for balance training. It is easily fixed between two trees and is perfect for playing, training or rehab. Complete kit with bag and tree protections



pg.8



31,10€

Art. TBEFS

BLOCCO PER STRETCHING tendineo e muscolare (flessori caviglia e coscia, dorso etc.) con appoggio soffice e sagomato a 2 inclinazioni ideale per il defaticamento e per il recupero
STRETCHING BLOCK for ankle, leg, back muscles and tendons - with soft double inclination very good for after-training exercises

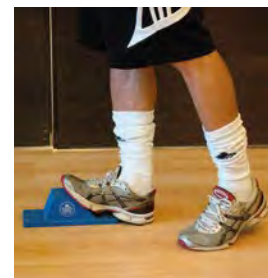

● I numeri in giallo indicano la pagina di riferimento del Listino Prezzi 2024-2025



Art. V9178 569,00€

Plinto per pliometria regolabile in altezza da cm. 30 a cm. 45 in tubolare di acciaio zincato piano di appoggio in legno multistrato dim. cm.150x30
 Plyometric bench adjustable heights (from 30 to 45 cm.) in galvanized steel wooden board dim. 150x30 cm.



402,00€

581,00€

870,00€

100cm

200cm

300cm

Art. 1PP40/2PP40/3PP40
 1PP50/2PP50/3PP50

Panca per pliometria in acciaio verniciato, lunghezze disponibili: cm. 100 / cm. 200 / cm. 300 larghezza cm. 35 altezze disponibili: cm. 40 / cm. 50 piano di appoggio in legno rivestito in gomma antiscivolo

Plyometric bench in painted steel, available length 100 / 200 / 300 cm. width 35 cm. available height 40 / 50 cm. board made of wood with anti-skid rubber cover



New!



Art. S3PP Set 3 piattaforme pliometriche con 3 diverse altezze: cm. 30, cm. 45 e cm. 60 rivestimento antiscivolo sulla parte superiore e cuscinetti in gomma sotto ciascuna piattaforma per una maggiore sicurezza - impilabili per un pratico stoccaggio

310,00€

Set of 3 plyometric platforms with 3 different heights: 30 cm., 45 cm. and 60 cm. Anti-skid coating on top and rubber pads under each platform for added safety. Stackable for practical storage



Art. AHF-140

Parallelepipedo per pliometria in legno cm. 76x61x51 utilizzabile a 3 diverse altezze
 Wooden plyometric box 76x61x51 cm. 3 different heights

197,00€



Art. AHF-255

Parallelepipedo per pliometria in legno cm. 76x61x51 utilizzabile a 3 diverse altezze con finitura antiscivolo
 Wooden plyometric box 76x61x51 cm. 3 different heights anti-skid treatment

211,50€

pg.10



Art. AHF-164

Parallelepipedo per pliometria in legno cm. 76x61x51 utilizzabile a 3 diverse altezze con imbottitura in EVA sp. cm. 2
 Wooden plyometric box 76x61x51 cm. 3 different heights EVA padding 2 cm. thickness

407,80€

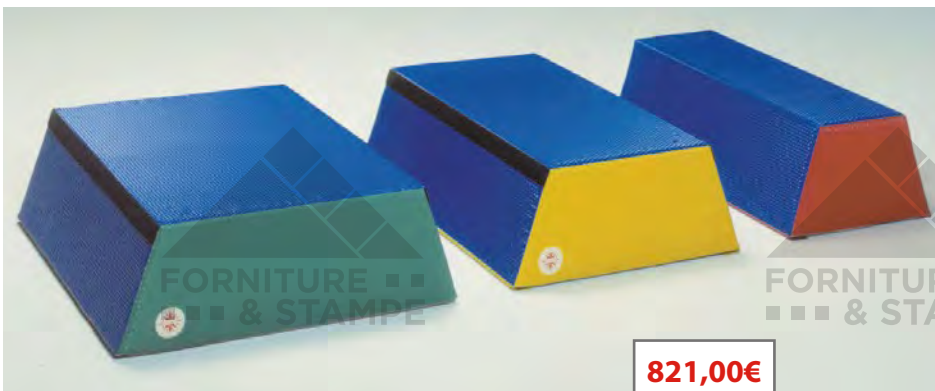

821,00€

Art. PAV2 Set 3 plinti soft a basi rettangolari in gommapiuma rivestita con PVC ignifugo Cl. 1, sovrapponibili - 3 altezze ottenibili: cm. 30, cm. 60, cm. 90
 Set of 3 rectangular base soft steps - by placing them one upon the other you can get 3 different heights: 30, 60, 90 cm.



501,00€

60cm

626,00€

70cm

778,00€

80cm

Art. VCU60 / VCU70 / VCU80
Cubo per pliometria in legno verniciato al naturale con gomma antiscivolo sui piani di appoggio lato cm. 60/70/80
 Wooden plyometric cube with anti-skid rubber 60/70/80 cm. side

I numeri in giallo indicano la pagina di riferimento del listino Prezzi 2024-2025

TRAMPOLINI - Trampolines



93,40€

Art. 166

Trampolino elastico Ø cm. 97
Trampoline Ø 97 cm.



215,00€

Art. TF-03

Trampolino elastico Ø cm. 122
pieghevole - 40 molle
Trampoline Ø 122 cm.
foldable - 40 springs

965,00€

Art. V1709

Trampolino elastico
ad altezza fissa
dim. cm. 125x125
Trampoline 125x125 cm.
reinforced



2275,00€

Art. S01154

Trampolino elastico
ad inclinazione
regolabile
completo di protezioni
dim. cm. 125x125
Trampoline
size 125x125 cm.
adjustable inclination
with soft perimetric
protection

526,00€

Art. TRO-9

Trampolino da esterno Ø cm. 305
con rete di protezione perimetrale
Outdoor trampoline Ø 305 cm.
with perimetric protection net



Numbers in yellow show the relevant page on 2024-2025 Price List

SCALE - CERCHI - CORDE - Speed Ladders - Hoops - Jumping Ropes



35,00€

Art. SL4

Scala lunghezza m. 4 con 10 pioli rotondi per esercizi di coordinazione motoria (compresa sacca per il trasporto)

Speed ladder length 4 meters with 10 tubular rungs for quick step and coordination exercises, bag included

pg.9

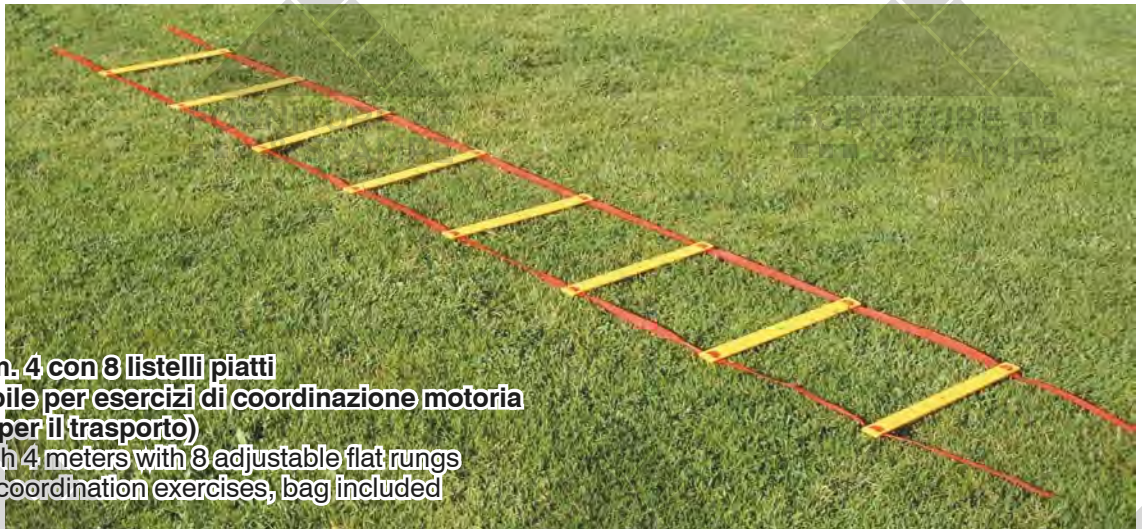

35,00€

Art. SL4LP

Scala lunghezza m. 4 con 8 listelli piatti a distanza regolabile per esercizi di coordinazione motoria (compresa sacca per il trasporto)

Speed ladder length 4 meters with 8 adjustable flat rungs for quick step and coordination exercises, bag included



42,90€

Art. SL6

Scala lunghezza m. 6 con 12 listelli piatti a distanza regolabile (compresa sacca per il trasporto)

Speed ladder length 6 meters with 12 adjustable flat rungs, bag included

I numeri in giallo indicano la pagina di riferimento del listino Prezzi 2024-2025

45,85€

Art. S4DB

Scala doppia lunghezza m. 4 con 20 listelli piatti a distanza regolabile per esercizi di coordinazione motoria (compresa sacca per il trasporto)
Double speed ladder length 4 meters with 20 adjustable flat rungs for quick step and coordination exercises, bag included



New!

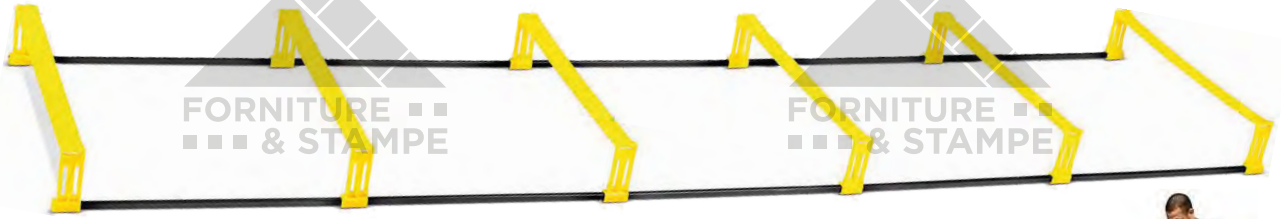

SKLZ

Art. SK.ELD

87,75€

ELEVATION LADDER

Scaletta cm. 213 trasformabile in serie di 6 ostacoli h. cm. 10
Switch between a flat ladder and a series of 6 hurdles h. 10 cm.



Art. B704086

Scala in plastica flessibile lunghezza m.4 con 10 pioli spessore cm.1,5 dimensione quadri cm.40x40 pieghevole con rimessaggio (ad esaurimento)

56,50€

Flexible speed ladder length 4 meters in plastic pipes 1,5 cm. thick - foldable with holder (until available)



pg.9



Art. 701411

Minibirillo concavo altezza cm. 9 per sollevamento scala Art. B704086 (ad esaurimento)

Cone 9 cm. height carved on top for Art. B704086 underneath support (until available)

Art. K4111

173,50€

Kit scala Art. B704086 + 20 Minibirilli Art. 701411 (ad esaurimento)

Kit Art. B704086 + 20 x Art. 701411 (until available)



I numeri in giallo indicano la pagina di riferimento del Listino Prezzi 2024-2025

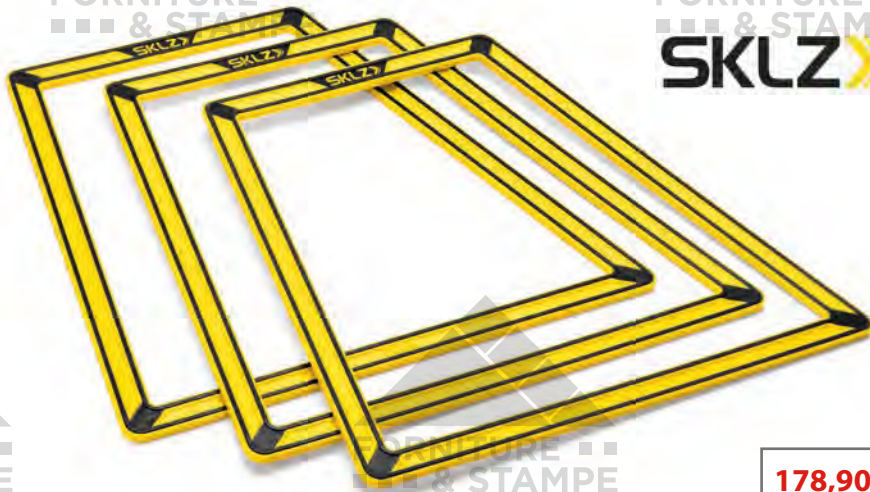

SKLZ

Esempi di combinazioni possibili
A few examples

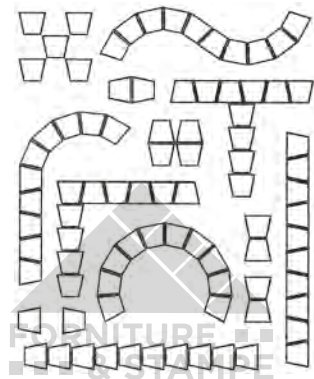

178,90€

Art. SK.ATP
AGILITY TRAINER PRO - set 10 TRAPEZI componibili per allenamento agilità e coordinazione multidirezionale, e per il miglioramento della velocità e dei tempi di reazione

Agility Trainer Pro - customizable footwork and agility trainer designed for curvilinear and alternative training patterns, cuts your reaction time while adding speed in all directions. Set of 10 trapezoids with a carry handle



Con questo nuovo strumento di allenamento creativo si possono incrementare le doti di rapidità, agilità e potenza nei cambi di direzione e nelle traiettorie curvilinee che gli atleti sono chiamati ad effettuare durante la gara. Questi speciali trapezi sono molto stabili su ogni tipo di terreno, permettendo così un esercizio senza interruzioni



Sports don't happen in a straight line, now neither does your training. The Agility Trainer Pro lets you recreate the curvilinear and broken patterns that take place in sports, helping you set up your cuts, turns and changes of direction. It lets you add the multi-directional quickness and precise footwork that can quickly change the game. The Agility Trainer Pro won't slip, slide or otherwise interrupt your training sessions

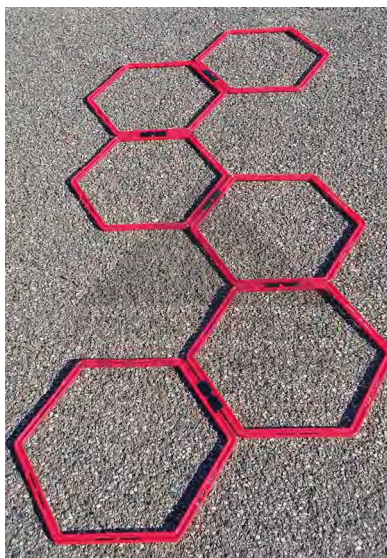
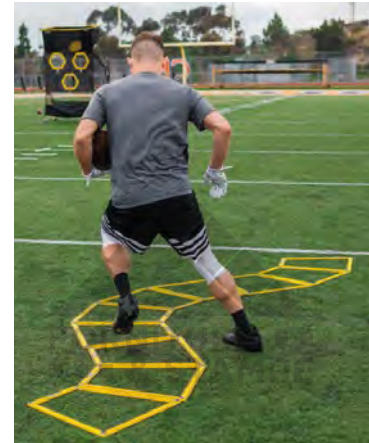

52,50€



Art. HEXS6 Set 6 esagoni in plastica componibili dim. cm.45x53 (altezza, larghezza) lato cm.28, completi di clip e borsa colori: giallo, verde, rosso, azzurro

Set of 6 modular plastic hexagons 45x53 cm. (height, width) complete with clips and bag - colors: yellow, green, red, royal

pg.9

I numeri in giallo indicano la pagina di riferimento del Listino Prezzi 2024-2025

Video dimostrativo disponibile su www.barretsport.com
Video available on www.barretsport.com

FORNITURE & STAMPE

257,00€

Art. SQ15
15 SQUARES

Telaio di cm. 300x200 in alluminio Ø mm.32

6 elastici con velcro consentono di formare 15 quadri per esercizi di coordinazione, reattività, riscaldamento e potenziamento muscolare con piedi di sostegno intercambiabili utilizzabile alle seguenti altezze dal terreno: cm.0 / cm.20 / cm.40 / cm.60
kit completo di borsa per il trasporto e di 6 elastici di ricambio (che consentono eventualmente di formare un numero maggiore di quadri)

Aluminium frame 300x200 cm. pipe Ø 32 mm. equipped with 6 elastic bands with velcro forming 15 squares for warm up, coordination, reactivity and jumping exercises with interchangeable sets of support feet adjustable at the following heights from ground: 0 cm. / 20 cm. / 40 cm. / 60 cm. with carrying bag and 6 additional spare elastics (which eventually allow you to form a greater number of squares)



h. cm. 60

9,75€

Art. SQ15.NS

Set 6 elastici con velcro di ricambio
Set of 6 spare elastics with velcro



h. cm. 40

pg.9



h. cm. 20



FORNITURE & STAMPE



Morbidi elastici flessibili fino a terra
Soft elastic bands flexible down to the ground

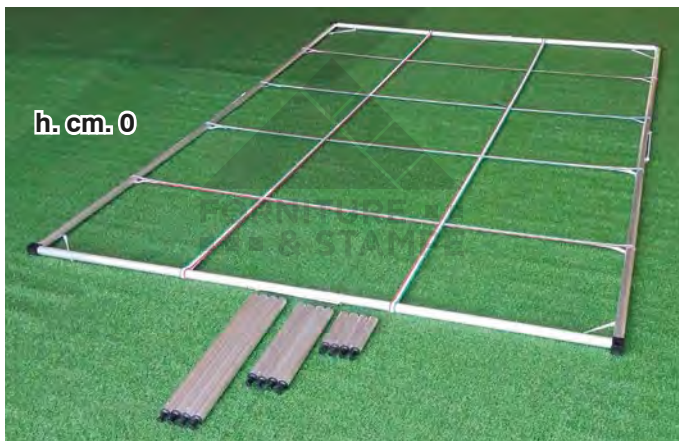

h. cm. 0

Numbers in yellow show the relevant page on 2024-2025 Price List

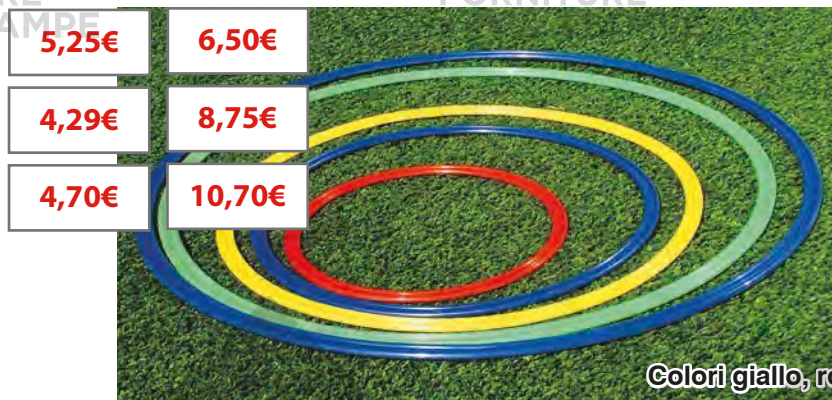

5,25€ 6,50€
4,29€ 8,75€
4,70€ 10,70€

Colori giallo, rosso, blu e verde

Art. CNP30 / CNP40 / CNP50 / P00181 / P00191 / P00201
Cerchio in nylon piatto Ø cm. 30 / 40 / 50 / 60 / 70 / 80
Flat Nylon Hoop Ø 30 / 40 / 50 / 60 / 70 / 80 cm.



7,80€
9,55€
11,50€
11,90€

Art. P00182 / P00192 / P00202 / P00212
Cerchio in PVC tubolare Ø cm. 60 / 70 / 80 / 90
Tubular PVC hoop Ø 60 / 70 / 80 / 90 cm.

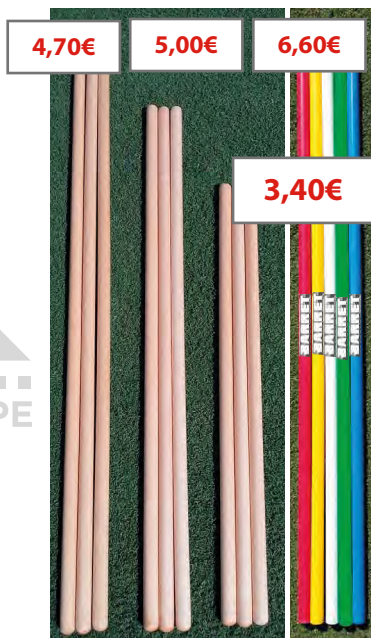

4,70€ 5,00€ 6,60€

3,40€

Art. S00402/S00405/S00406
Bastone in legno
cm. 80-100-120
80-100-120 cm. Wooden Stick

Art. E21
Bastone in PVC cm.120
120 cm. PVC Stick



114,70€

Art. S00414
Mensola porta bastoni a parete
in acciaio verniciato
Stick wall Holder in painted steel

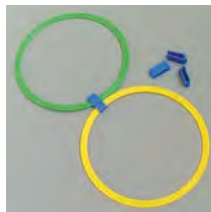

1,65€

Art. OCC11
Connettore per
cerchi piatti
Flat Hoop
Connector



pg.8

Art. S00472
Mensola porta cerchi a parete in
acciaio verniciato
Hoop wall Holder in painted steel

69,00€



3,75€

Art. 043P
Corda per salto in nylon
con manici in legno
Nylon Skipping Rope with
hardwood handles

pg.8



251,00€

Art. 043
Corda per salto in canapa con manici
in legno ed ingrossamento centrale
Hemp Skipping Rope with hardwood
handles, thicker in the middle section



Art. AHF-017

Corda per salto in PVC
con manici soft touch
e cuscinetti a sfera
PVC Skipping Rope with soft
handles and ball bearings

7,85€



4,90€

Art. CS1
Corda per salto in canapa con ingrossamento
centrale senza manici
Hemp Skipping Rope thicker in the middle without handles

Art. AHF-102
Corda per salto veloce in acciaio
con manici in plastica e cuscinetti
a sfera (lunghezza regolabile)
Steel Skipping Rope with plastic
handles and ball bearings
(adjustable length)



8,60€



Art. 043L Corda per
salto in pelle
Leather Skipping Rope
with hardwood handles

12,65€

20,15€



Art. STAR
Starkick completo di cintura e corda elastica per allenamento ai palleggi ed al tocco di palla (pallone escluso)
 Starkick with belt and elastic rope for ball kick and control training (ball not included)

38,80€



Art. PTI.15070
Soccer Ball Trainer completo di pallone, corda elastica di m. 12,5 e ancoraggio
 Soccer Ball Trainer with ball size 5 in TPU, rubber base, 12,5 m. elastic rope and 1 peg



Art. OTK **7,00€**
Training Kicker con corda non elastica per allenamento ai palleggi ed al tocco di palla (pallone escluso)
 Training Kicker with non elastic rope for ball kick and control training (ball not included)

271,00€



Art. TIM.SP
Supporto per Tackle Improver
 Holder for Tackle improver

Art. TIM
Tackle Improver per allenamento al contrasto
 For tackle training

Uno strumento innovativo per migliorare la tecnica di esecuzione e la potenza del contrasto. Il Tacke Improver indirizza il piede d'appoggio verso la posizione più idonea per esprimere la maggiore potenza d'impatto. Potenzia inoltre tutte le catene muscolari che intervengono nel contrasto, ma senza causare traumi, grazie ad una speciale molla collegata al pistone che sorregge il pallone.

Very useful training device for strengthening all muscles involved in tackling. Absolutely safe, thanks to a spring and piston system that avoids injuries.

251,00€



47,75€



Art. CVCO
Cavigliera Coordinativa con contrappeso, migliora l'equilibrio e l'indipendenza psicomotoria delle gambe, ed in particolare ammorbidisce la gamba dominante migliorandone la sensibilità del piede
 Rotating ankle, with weight, to improve equilibrium and leg independence: in particular it softens the dominant leg improving sensibility of the non dominant foot



Video dimostrativo disponibile su www.barretsport.com
 Video available on www.barretsport.com

ALLENAMENTO SOTTO CARICO E FUNZIONALE - Training with weights



95,50€

Art. ASN

Cintura in pelle sintetica con velcro completa di corda, catena e moschettoni di ricambio per slitta Art. SLD
Synthetic leather belt, rope and chains spare for Art. SLD



Art. SLD

139,50€

38,00€



Art. CBV

Cintura in pelle sintetica con velcro di ricambio per Art. SLD
Synthetic leather belt w/velcro spare for Art. SLD

Art. SLD Slitta per il miglioramento della capacità di accelerazione tramite il traino a carico variabile completa di cintura in pelle sintetica con velcro, corda e moschettoni (dischi in ghisa non inclusi)
Sledge (weights not included) improving acceleration with synthetic leather belt, rope and chains

pg.9



157,00€

SKLZ

Art. SK.SPSC
SPEED SAC - sacca di traino con pesi munita di cintura e moschettoni utilizzabile anche indoor o su superfici sintetiche

Improves overall speed and explosiveness, boosts acceleration and stride length. Adjustable weight options for variable resistance portable and versatile to be used anywhere



In dotazione 3 sacchi di capacità Kg. 4,5 da riempire con sabbia
Includes 3 x 4,5 Kg. sacs to be filled with sand



66,70€

10

177,00€

20

247,65€

30

Art. 045 / AHF-112 / AHF-113

Giubbino caricabile con pesi fino a Kg.10-20-30 (pesi inclusi)

Jacket Weighted up to 10-20-30 Kg. (weights included)



Art. PCH

Paracadute per potenziamento della corsa

Parachute to improve the power of your run

40,75€

pg.9

I numeri in giallo indicano la pagina di riferimento del Listino Prezzi 2024-2025

34,40€	44,70€
2 kg	5 kg
36,90€	48,60€
3 kg	6 kg
40,80€	
4 kg	

Art. TBB2 / ... / TBB6
Body Bar
 Kg. 2-3-4-5-6 per
 allenamento funzionale
 con pesi liberi
 Body Bar
 2-3-4-5-6 Kg.
 for functional training
 with free weights



pg.12



Art. 991310M/991311M/991312M

Shoulder Bag
 con 3 impugnature
 pesi disponibili Kg. 10-15-20
 Shoulder Bag with
 3 handles
 weights available 10-15-20 Kg.

pg.9

Shoulder Bag kg. 5 e kg. 12
 disponibili fino ad esaurimento scorte
 Shoulder Bag 5 kg. and 12 kg.
 until available



82,80€

90,20€

99,10€

111,00€

130,20€

**Art. APBG-5/APBG-10/APBG-15/
 APBG-20/APBG-25**

Borsa zavorrata
 con 6 impugnature
 pesi disponibili Kg.5-10-15-20-25
 Heavy Bag with 6 handles
 weights available 5-10-15-20-25 Kg.

pg.9

Art. WBG
Borsa gonfiabile zavorrata con acqua a peso variabile
 (capacità da 5 a 25 litri) lunghezza cm. 90 con 4 maniglie
 consente nuovi esercizi di forza coordinata
 grazie alla massa oscillante interna - pompa inclusa

Inflatable bag with water inside (from 5 up to 25 liters), length 90 cm.
 with 4 handles, allows new exercises for muscle strength thanks to
 the dynamic weight inside - pump included

87,70€

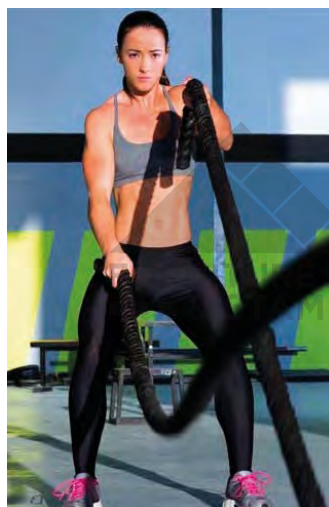

Art. BR-3812 / BR-5015

Fune da allenamento
Battle Rope

ø mm 38 lunghezza mt. 12
 oppure

ø mm 50 lunghezza mt. 15
 Battle Rope

12 meters - 38 mm. thick or
 15 meters - 50 mm. thick

pg.9



116,20€

12 m

199,00€

15 m

In poliestere intrecciato con impugnature rivestite in gomma termoretraibile
 ideale per il potenziamento dei muscoli di spalle e avambracci,
 ottimo allenamento cardiorespiratorio

Polyester encased rope with shrink-wrap handles, perfect for strengthening shoulders
 and forearm muscles, excellent cardio-respiratory workout



pg.9

FT.IST
Functional Training
Attrezzo polifunzionale
per il potenziamento della catena estensoria
e flessoria degli arti superiori e inferiori
 Functional Training multi-purpose
 belt for the enhancement
 of the extension and flexion muscular
 chains of the upper
 and lower limbs

51,10€



FST-DBL

Functional Training Double Pro
Attrezzo professionale per allenamento
in sospensione con maniglie svincolate
utilizzabili separatamente
 Functional Training with free handles to be used also
 separately - steel snap hooks and rings

79,90€



MTLTX
Lacci di Trazione
 Traction Laces

93,40€

pg.9

PLTRZ
Prolunga
per Lacci
di Trazione
 Extension for
 Traction Laces

62,20€



Attrezzo polifunzionale per il potenziamento della catena estensoria e flessoria degli arti superiori e inferiori
 Multi-purpose belt for the enhancement of the extension and flexion muscular chains of the upper and lower limbs



Art. DTL15
Lacci di Trazione
dinamici
con carrucola
 Dynamic functional
 training with pulley

171,00€

BANDE ELASTICHE - BOA - Elastic Bands



pg.11

9,55€

Art. IFBG
Fitness band cm. 175x15
colore giallo
Yellow fitness band

11,30€

Art. IFBR
Fitness band cm. 175x15
colore rosso
Red fitness band

12,40€

Art. IFBB
Fitness band cm. 175x15
colore blu
Blue fitness band

14,35€

Art. IFBN
Fitness band cm. 175x15
colore nero
Black fitness band

4,90€

Art. AHF-141
Coppia maniglie per fitness band
Pair of handles for fitness band

4,40€

arancio

18,15€

viola

pg.12

8,00€

rosso

27,30€

verde

13,20€

nero

37,25€

blu



83,70€



Art. RLEV
Rotolo lattice verde per esercizi muscolari,
larghezza cm. 15, lunghezza mt. 25
spessore 0,3 mm.

Elastic green Band for muscle exercises,
15 cm. wide, 25 meter long, thick 0,3 mm.

Art. RLEF **101,25€**

Rotolo lattice fucsia per esercizi muscolari,
larghezza cm. 15, lunghezza mt. 25
spessore 0,4 mm.

Elastic fuchsia Band for muscle exercises,
15 cm. wide, 25 meter long, thick 0,4 mm.



pg.11



112,40€

Art. RLEB
Rotolo lattice blu per esercizi muscolari,
larghezza cm. 15, lunghezza mt. 25
spessore 0,5 mm.

Elastic blue Band for muscle exercises,
15 cm. wide, 25 meter long, thick 0,5 mm.



4,70€

4,90€

extra strong

New!

Art. MBLT MINI BAND LIGHT in poliestere ø cm.20,70 h.mm.50
Art. MBME MINI BAND MEDIUM in poliestere ø cm.18,80 h.mm.50
Art. MBST MINI BAND STRONG in poliestere ø cm.19,10 h.mm.50
Art. MBEX MINI BAND EXTRA STRONG in poliestere ø cm.19,10 h.mm.54

Polyester Mini Bands

38,90€

giallo

47,40€

rosso

52,10€

verde



Art. 991707 / 991708 / 991709

SET 10 ELASTICI AD ANELLO colore giallo (morbido)
rosso (medio) - verde (resistente) Ø cm. 27,50
Set of 10 Elastic Rings yellow (soft)
red (medium) - green (hard) Ø 27,5 cm.

Art. AHF-251/AHF-128/AHF-129
AHF-130/AHF-131/AHF-132

Elastico ad anello POWER BAND
circonferenza cm. 208 spessore mm. 4,5
larghezza arancio mm. 6,4 - rosso mm. 13
nero mm. 22 - viola mm. 29 - verde mm. 45 - blu mm. 64
Power Band elastic circumference cm.208 - 4,5 mm. thick
orange 6,4 mm. width - red 13 mm. width
black 22 mm. width - violet 29 mm. width
green 45 mm. width - blue 64 mm. width

43,10€

Art. KER-IS

Set 5 elastici con 5 diverse resistenze dotati di ganci metallici da entrambi i lati. Completo di 1 coppia di maniglie, 1 coppia di cavigliere, 1 accessorio per bloccare l'elastico contro una porta e utilizzare un arto per volta, 1 sacca

Set of 5 elastic bands with 5 different resistances equipped with metal hooks on both sides. Complete with 1 pair of handles, 1 pair of ankle bands, 1 accessory to lock the elastic against a door and use one limb at a time, 1 bag



Here are some examples of the door anchor in action:

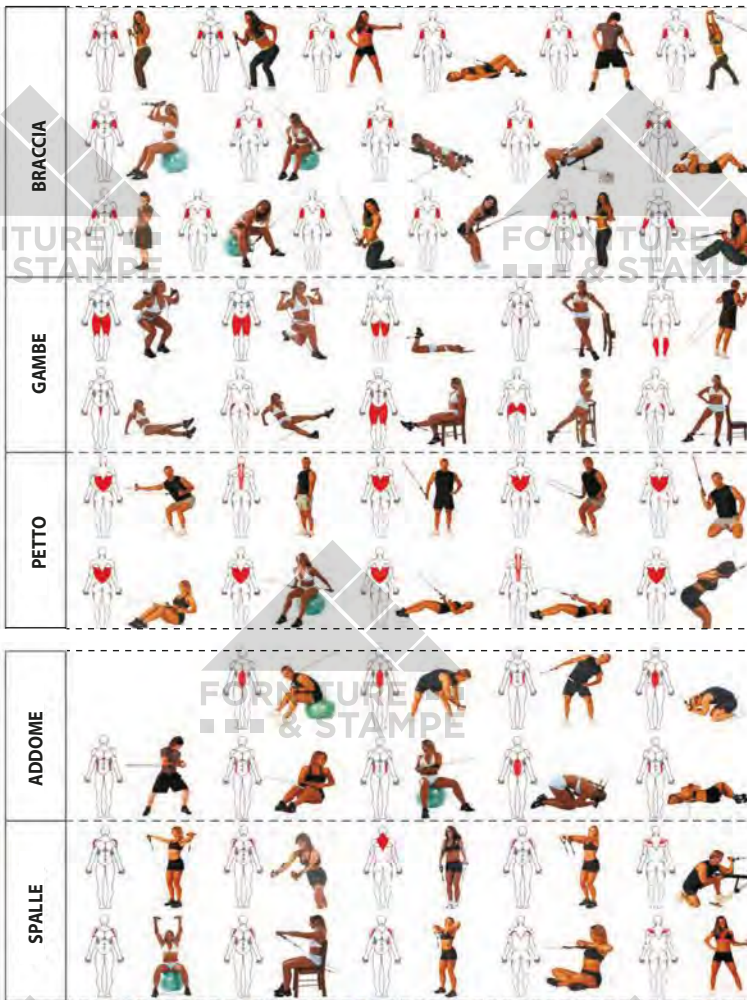

GANCIO SU 1 ELASTICO GANCIO SU 2 ELASTICI GANCIO SU 3 ELASTICI GANCIO SU 4 ELASTICI GANCIO SU 5 ELASTICI



COLORE ELASTICO	LIVELLO DI RESISTENZA	LIVELLO DI RESISTENZA	DIMENSIONI
GIALLO	EXTRA LEGGERO	2,7 kg - 3,6 Kg	5X8X1100MM
VERDE	LEGGERO	4 kg - 5 Kg	6X9X1100MM
ROSSO	MEDIO	5,5 kg - 6,75 Kg	5X9X1100MM
BLU	FORTE	6,75 kg - 9 Kg	5X10X1100MM
NERO	EXTRA FORTE	9,45 kg - 11,25 Kg	6X11X1100MM

1. Your resistance bands come in 5 different resistance levels, noted by a different band color. Please refer to the table for more information on the levels of resistance
2. You can use any or all of the bands at one time during your workouts
3. Attach one end of the band(s) to the foam handles or ankle straps and same on the other end
4. The door anchor will attach anywhere on a standard door, including the bottom of the door. To use the door anchor, ensure the bigger end is attached to the apposite side of door and feed the thin end through. Once the thin end is through you can feed the exercise band through it. Ensure the door is fully closed before performing any exercise

Resistance Band Color	Resistance level	Resistance level	Dimensions
Yellow	X- Light	6lbs - 8lbs	5X8X1100MM
Green	Light	9lbs - 11lbs	6X9X1100MM
Red	Medium	12lbs - 15lbs	5X9X1100MM
Blue	Heavy	15lbs - 20lbs	5X10X1100MM
Black	X-Heavy	21lbs - 25lbs	6X11X1100MM

pg.11

20,50€

Art. PTI.SPS

Slide Pads - paio di slide pads utilizzati per esercizi di scivolamento di mani e piedi volti al miglioramento della flessibilità e della forza muscolare

Conditioning tool to improve flexibility, shaping and core strength, simulates many slide board exercises
Set of 2 pcs



I numeri in giallo indicano la pagina di riferimento del listino Prezzi 2024-2025

15,40€

rosso

16,30€

giallo

17,65€

viola

19,50€

nero

Art. 991710/ ... /991738

Elastico tubing con maniglie
colore rosso, giallo, viola, nero
Elastic with handles
red, yellow, violet, black color



Art. 991714/ ... /991742

Elastico tubing mt.10 senza maniglie
colore rosso, giallo, viola, nero
10 meter elastic without handles
red, yellow, violet, black color

67,50€

rosso

77,50€

giallo

86,65€

viola

95,75€

nero

pg.11

15,30€

Art. AHF-167

Elastico tubolare con guaina
e maniglie light cm.150x15
spessore mm. 0,35
Light elastic tube with sheath
and handles 150x15 cm.
thickness 0,35 mm.

16,45€

Art. AHF-168

Elastico tubolare con guaina
e maniglie medium cm.150x15
spessore mm. 0,50
Medium elastic tube with sheath
and handles 150x15 cm.
thickness 0,50 mm.

17,75€

Art. AHF-169

Elastico tubolare con guaina
e maniglie strong cm.150x15
spessore mm. 0,65
Strong elastic tube with sheath
and handles 150x15 cm.
thickness 0,65 mm.



21,25€

Art. AHF-068

Set 3 elastici tubing con maniglie
tre differenti livelli di resistenza
impugnature ergonomiche soft touch
per esercizi arti superiori e inferiori
completo di borsa in microrete
Set of 3 elastics with soft touch handles
3-level resistance, bag included
tones and strengthens
arms, legs, gluteus, abdominals,
shoulders and chest muscles



94,50€

Art. ARS.3

Banda Elastica rinforza spalle - può essere usata in ogni luogo che abbia un appiglio per la chiusura a velcro (anche in casa o in albergo) grazie alla presenza di uno spessore che, a porta chiusa, non fa scivolare l'attrezzo e non danneggia la porta
Elastic Band for shoulder injury training exercises

pg.10

I numeri in giallo indicano la pagina di riferimento del Listino Prezzi 2024-2025

Art. 016824

ELASTICO BOA in gomma para mm. 7x18 rivestito con guaina di sicurezza lunghezza mt. 3 con un moschettone a ciascuna estremità, resistenza Kg. 50

Rubber BOA 7x18 mm. with safety sheath 3 meter length, resistance 50 Kg.

146,30€

pg.11



Art. 016824
ELASTICO BOA

Art. 016826
CINTURA Senior

32,90€

Art. 016825

CINTURA Junior da agganciare a elastico BOA diametro max cm.105

Junior Belt for BOA traction - max diameter 105 cm.

36,40€

Art. 016826

CINTURA Senior da agganciare a elastico BOA diametro max cm.140

Senior Belt for BOA traction - max diameter 140 cm.

pg.11



Art. 016827

Paio polsini per elastico BOA
Pair of wristbands for BOA exercises

75,65€

Si suggerisce l'utilizzo dell'elastico BOA con una cintura o con un altro tra gli accessori disponibili

Utilization of rubber Boa is suggested with a belt or with another available accessory



Art. 016828

Paio cavigliere per elastico BOA
Pair of anklebands for BOA exercises

76,90€



50,55€

Art. 016829

Pettorina per elastico BOA
Shoulder belt for BOA exercises



Art. C3005

Staffa per ancoraggio elastico BOA a parete
BOA wall anchor bracket

24,15€



Anello scorrevole
"free-floating" ring



SKLZ

109,80€

Art. SK.R360

RECOIL 360 - elastico con cintura ad anello scorrevole utilizzabile in autonomia o con l'aiuto del preparatore resistenza Kg. 22

Maximizes power, speed and vertical jump
Engineered with a "free-floating" ring for 360 degrees of movement

Designed for solo use or for training with a partner resistance 22 Kg.

pg.11

DYNAMIC RESISTANCE / ASSISTANCE TRAINER



Numbers in yellow show the relevant page on 2024-2025 Price List

● I numeri in giallo indicano la pagina di riferimento del listino Prezzi 2024-2025

Art. SK.ACTR 111,80€

ACCELERATION TRAINER

per l'allenamento della velocità in ogni direzione, dell'accelerazione e della velocità massima

Da utilizzare con l'aiuto del preparatore

Trains speed in every direction

Builds speed and power from the start, during acceleration and at the top-end

Designed for training with a partner



pg.11

DYNAMIC OVERLOAD AND RELEASE SYSTEM



Anello scorrevole "free-floating" ring

SKLZ



Art. SK.LRP

54,80€

LATERAL RESISTOR PRO

Attrezzo per migliorare la velocità del primo passo e la rapidità laterale con elastici tubolari intercambiabili a diversa resistenza

Develops first-step quickness and lateral speed

Patented Slide-Lock system for quick, safe switching of resistance cables

SKLZ

STRENGTH AND SPEED TRAINER



pg.10

VERTICAL JUMP TRAINER



Art. SK.HPZ
HOPZ 2.0

126,50€

Attrezzo per migliorare la forza e la potenza dei muscoli impegnati nell'elevazione, con elastici tubolari intercambiabili a diversa resistenza

Builds explosive leg power and strengthens jumping muscles

You can move resistance cables on belt to target specific muscles and change resistance cable quickly



● Numbers in yellow show the relevant page on 2024-2025 Price List

I numeri in giallo indicano la pagina di riferimento del Listino Prezzi 2024-2025



34,90€

Art. AE
Banda elastica
Anton elast
per esercizi di
stretching e
potenziamento
muscolare
Elastic band for
body muscle
exercises



Con velcro cucito su
entrambe le estremità
with velcro seamed at
both sides



pg.10



48,00€

Art. RA
Rinforza Abduttori
Elastic band for
abductor muscles

Con velcro cucito su
entrambe le estremità
with velcro seamed at
both sides

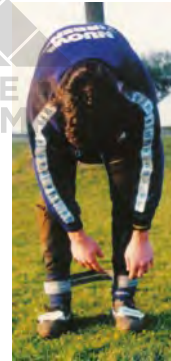

55,50€

Art. OSI
Over Speed Improver - Tramite questa cintura elastica l'atleta più veloce
trascina il più lento, incrementando contemporaneamente la velocità di entrambi
By this elastic belt the quicker player pulls the slower player, increasing both athletes' speed



Con velcro cucito su
entrambe le estremità
with velcro seamed at
both sides

pg.11



Art. PSR
Power Speed
Resistor
per potenziamento
della corsa
esercizio in coppia
(nylon non elastico)
To improve explosive
force - two people
involved (non elastic
band)

251,00€



Art. EPW
Elastic Power
2 fasce con cintura
in pelle
incrementa
la forza esplosiva
potenziando la
muscolatura delle
gambe e del dorso
2 Bands with leather belt
for explosive strength
improvement, for leg and
back muscle training

pg.11

29,25€

I numeri in giallo indicano la pagina di riferimento del Listino Prezzi 2024-2025



38,00€

Art. SRE
Cintura elastica
Elastic belt

Speed Reaction
Allenamento dei riflessi e della reattività
(l'elastico non si sgancia se il difensore perde contatto dall'attaccante)
Reflex and reactivity training device (the belt does not separate if the defender loses contact)



Cintura non elastica
Non elastic belt

19,00€

Art. EB
Evasion Belt - Allenamento dei riflessi e della reattività ideale per marcature a uomo (la cintura si sgancia se il difensore perde contatto dall'attaccante)
Reflex and reactivity training device, for man to man coverage (the defender loses contact)

pg.11



Art. RIM
Reaction Improver per l'allenamento della reazione allo stimolo visivo in percorsi ad ostacoli, ideale per marcature a uomo (l'elastico si stacca se si perde contatto)
Elastic Belt for visual reflex training in drill sections, for man to man coverage (the elastic separates if following athlete loses contact)

38,00€

pg.11



479,00€

Art. KAT Kit allenamento tattico composto da 7 bande elastiche di metri 10 ciascuna
Tactical training kit made of 7 elastic bands 10 meter long each

pg.11

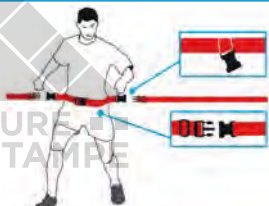

95,50€

Art. 05020798

Set di 4 cinture con dispositivo di fissaggio e 3 fasce non elastiche lunghe m. 10 ciascuna

Con questo prodotto è possibile vincolare quattro difensori allenandone il posizionamento ed i movimenti sul campo (ad esaurimento scorte)

Set of 4 hip belts with fasteners and 3 unelastic bands 10 m. long each
With this kit you can connect all four players of your defensive block, training their positioning and movements on the field (until available in stock)

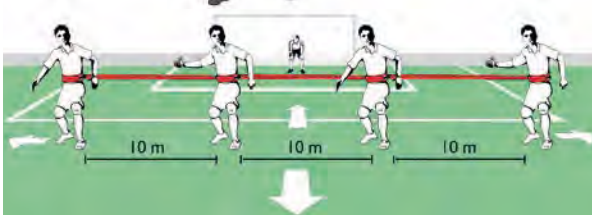

● I numeri in giallo indicano la pagina di riferimento del Listino Prezzi 2024-2025



New!



128,70€

Art. CGG24

pg.7

Cuscino gonfiabile con maniglie cm.70x50 per contrasto alle uscite alte del portiere
Inflatable cushion 70x50 cm. with handles for football goalkeeper exit training



New!

19,30€

Art. ELAC Fascia elastica ad anello in tessuto extra strong circonferenza cm. 400 - h. cm.5 pensata per l'allenamento multidirezionale consente lo sviluppo di forza, esplosività, velocità, agilità e salto

Elastic extra strong fabric loop band circumference 400 cm. - h. 5 cm. designed for multidirectional training allows the improvement of strength, explosiveness, speed, agility and jumping

pg.11



438,00€

Art. KAP

Kit allenamento portiere composto da 10 Antonelast, 1 cintura, 1 Rinforza Abduttori, 4 anelli fissa bande per il miglioramento della forza esplosiva

Goalkeeper training kit made of 10 Antonelast, 1 belt, 1 abductor muscle band, 4 connecting rings to improve explosive muscular strength and goalkeeper's jumps and dives



(ad esaurimento scorte)
(until available in stock)

66,30€

**Art. 05021456
JUMP-TRAINER**

pg.10

Strumento per migliorare la potenza nel salto. Un atleta indossa la cintura regolabile con velcro, due compagni trattengono le fasce elastiche salde a terra lunghezza delle fasce elastiche m. 1,20 ciascuna (in posizione di riposo) (ad esaurimento)

Training tool to improve jump power. One player puts on the adjustable hip belt with velcro fastener, two training partners hold the elastic bands on the ground using their feet. Length of elastic side bands (not stretched) 1,20 m. (until available)

● I numeri in giallo indicano la pagina di riferimento del Listino Prezzi 2024-2025

598,00€

Art. SC010

pg.10

OFFERTA KIT TECNICO SCUOLA CALCIO

Kit così composto: n.15 paletti slalom Art.007

n. 15 basi ad imbuto Art.018 - n. 1 kit delimitatori Art.016 - n. 6 ostacoli over cm.12 Art.80.12
n. 2 ostacoli over cm.20 Art.80.20 - n. 2 ostacoli over cm.30 Art. 80.30 - n. 2 ostacoli over cm.40 Art.80.40
n. 12 corde salto Art.043P - n. 1 scala a pioli Art. SL4 - n. 12 maxidelimitatori h.cm.28 Art.019.1
n. 12 cerchi piatti diam.cm.50 Art.CNP50 - n. 1 tavoletta propriocettiva in ABS Art.168PC

SOCCER SCHOOL KIT SPECIAL OFFER

15 x Art.007 + 15 x Art.018 + 1 x Art.016 + 6 x Art.80.12 + 2 x Art.80.20 + 2 x Art.80.30 + 2 x Art.80.40
+ 12 x Art.043P + 1 x Art.SL4 + 12(pieces) x Art.019.1 + 12 x Art.CNP50 + 1 x Art.168PC



Art. 80.12/80.20/80.30/80.40

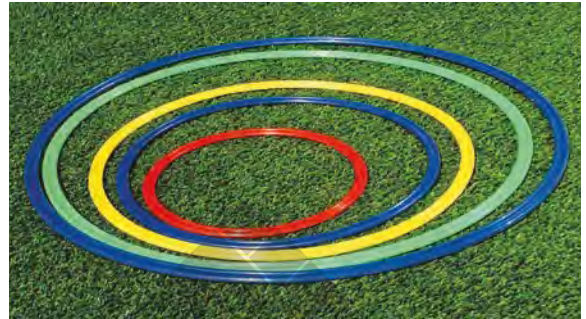

Art. CNP50



Art. 007



Art. 016



Art. SL4



Art. 019.1



Art. 168PC



Art. 018



Art. 043P

I numeri in giallo indicano la pagina di riferimento del listino Prezzi 2024-2025

FITNESS BODY-BUILDING

Art. S01108

Art. S01106



Art. S01106 **439,00€**

Spalliera Svedese a 1 campata
dim. cm. 90x250
in faggio evaporato
Swedish Wall Bar 1 span

pg.14

Art. S01108 **722,00€**

Spalliera Svedese a 2 campate
dim. cm. 180x250
in faggio evaporato
Swedish Wall Bar 2 spans



97,30€

Art. F302
Porta dischi in ferro
Weight Plates Rack

5,65€

0,5

67,80€

6

11,30€

1

22,60€

2

33,90€

3

45,20€

4

56,50€

5

Art. UNG05 / UNG1 / UNG2 / UNG3 / UNG4 / UNG5 / UNG6

Coppia Manubri in ghisa rivestiti

Kg. 0,5-1-2-3-4-5-6 cadauno

Pair of Dumbbells 0,5-1-2-3-4-5-6 Kg. each one

34,40€

6

40,15€

7

45,85€

8

51,60€

9

57,35€

10

Art. MEG6 / MEG7 / MEG8 / MEG9 / MEG10

Manubrio esagonale con rivestimento in gomma Kg. 6-7-8-9-10
(fornito singolarmente)

Hexagonal Dumbbell with rubber coating 6-7-8-9-10 Kg.

New!

pg.12



100,40€

Art. F301
Porta manubri in ferro
Dumbbell Rack



in giallo indicano la pagina di riferimento del listino Prezzi 2

48,90€ 57,50€
150 cm 180 cm

5,90€



Art. AS196
Coppia fermadischi a vite
Ø mm. 25
Pair of plate holders with thread

pg.12

Art. US176 4,90€
Coppia fermadischi a T
Ø mm. 25
Pair of T-shaped plate holders

****Art. US304 / US305**
Bilanciere cm. 150 / cm. 180
Ø mm. 25
Barbell length 150 / 180 cm.

16,60€

****Art. US301** Manubrio a dischi inseribili
cm. 35 Ø mm. 25
Hand bar length 35 cm.



****Fermadischi inclusi**
Plate holders included
Carico massimo Kg. 100
Maximum load 100 Kg.

****Art. US303** 43,25€
Bilanciere sagomato
cm. 120 Ø mm. 25
Barbell length 120 cm.



Art. UN640 5,15€
Disco in ghisa foro mm. 25
Kg. 0,5 - 1 - 2 - 5 - 10 - 15 - 20
cadauno
Cast Iron Weight Plate
hole 25 mm.



5,77€

Art. DGG
Disco in ghisa foro mm. 25
rivestiti in gomma
Kg. 0,5 - 1 - 2 - 5 - 10 - 15 - 20 cadauno
Cast Iron Weight Plate hole 25 mm.
covered with rubber

Art. US287
Coppia fermadischi a molla
Ø mm. 25
Pair of spring plate holders



2,80€



Art. BO220 193,00€
Bilanciere olimpionico cm. 220
cromato per dischi con foro da mm. 50
carico massimo Kg.320 - fermadischi non inclusi
Chromed olympic barbell 220 cm.
maximum load 320 Kg. for plates with hole 50 mm. only
(plate holders not included)

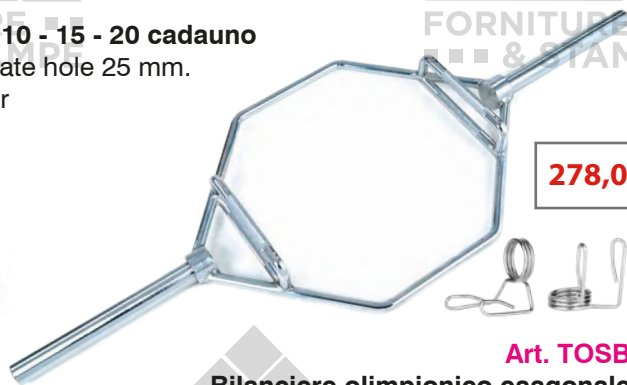

Art. TOSB 278,00€
Bilanciere olimpionico esagonale
cm. 145 con doppia impugnatura (shrug bar)
per dischi con foro da mm. 50 - carico massimo Kg.300
fermadischi a molla inclusi
Hexagonal olympic barbell 145 cm. with double handle
for plates with hole 50 mm. - maximum load 300 Kg.
spring plate holders included



Art. CFSL 13,00€
Coppia fermadischi per Art. BO220 - Ø mm. 50
Pair of plate holders for Art. BO220



189,00€

New!

Art. AHF-155 Landmine Total Core
Piattaforma con superficie inferiore antiscivolo, snodo rotante a 360° e doppio innesto per bilanciere
Ø mm. 25 / mm. 50 - dotato di maniglia "T-Bar" per estendere la gamma di esercizi
Platform with anti-skid lower surface, 360° rotating pin and double joint for Ø 25 / 50 mm. barbell equipped with "T-Bar" handle to extend the range of exercises

Art. DBCH5/ ... /DBCH25
Disco Bumper gommato con foro diametro mm. 50 per bilanciere olimpionico disponibile nelle seguenti grammature:
Kg.5 - 10 - 15 - 20 - 25
Bumper Weight Plate hole 50 mm. covered with rubber



46,70€ 76,00€ 109,70€
5 10 15
138,75€ 172,40€
20 25



Art. DGG-TRG 6,80€
Disco in ghisa gommato tri grip foro diametro mm. 50 per bilanciere olimpionico disponibile nelle seguenti grammature:
Kg.1,25 - 2,5 - 5 - 10 - 15 - 20 - 25
Tri grip cast iron Weight Plate hole 50 mm. covered with rubber

9,10€ in c 13,00€ pag 18,20€ de 22,10€ 24-2025

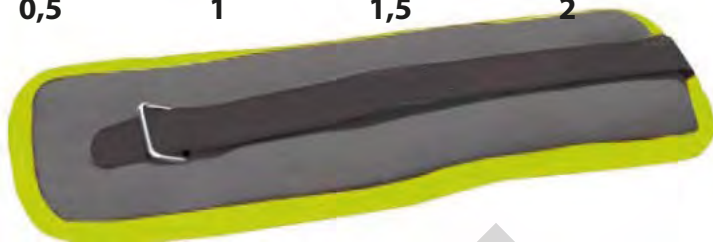

Art. 13382 / 13383 / 13384 / 30937
Paio Cavigliere Kg. 0,5 - 1 - 1,5 - 2 cadauna
 Pair of Ankle Weights 0,5 - 1 - 1,5 - 2 Kg. each one



Art. AHF-093 **27,10€**
Paio Cavigliere Kg. 2,5 cadauna con pesi estraibili
 Pair of Ankle Weights 2,5 Kg. each removable weights



Art. 17222 **20,50€**
Cintura Body Building - misure da XS a XL
 Body Building Leather Belt - sizes from XS to XL



18,70€ **Art. AHF-074**
Coppia sostegni ruotabili per flessioni
 Turnable Push-up handles

pg.12

pg.13



Art. AHF-026 **12,70€**
Coppia maniglie per flessioni
 Push-up handles



12,70€ **Art. AHF-047**
Ruota doppia per addominali
 Double Wheel for abdominal muscles

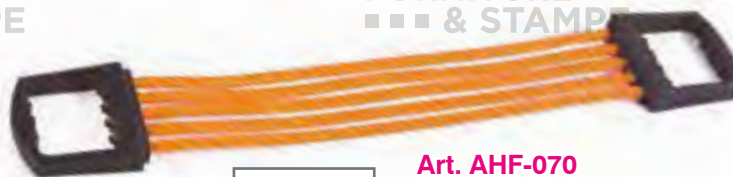

14,15€ **Art. AHF-070**
Estensore con elastici
 Chest-Expander

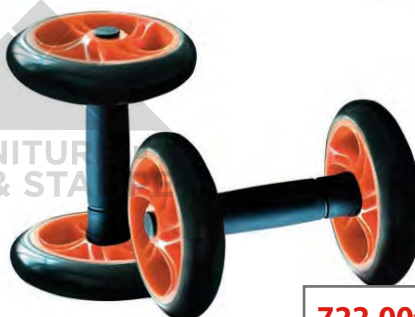

722,00€ **Art. AHF-157**
Coppia manubri con ruote per addominali
 Pair of dumbbells with wheels for abdominal muscles



114,30€ **Art. AHF-161**
Coppia Parallettes h. cm. 75
 Pair of Parallettes 75 cm. height



18,70€ **Art. AHF-064**
Contapassi multifunzione
 Multi-function Step Counter



7,70€ **Art. 17203**
Paio guanti Lycra
 misure da XS a XL vari colori
 Gym Gloves Lycra



13,85€ **Art. 30907**
Paio guanti Premium Pro
 misure da S a XL vari colori
 Gym Gloves Premium Pro



6,25€ **Art. AHF-021**
Coppia Tenaglie stringimano
 con impugnatura soft touch
 Pincers for hand strengthening



126,75€

Art. DEAPWR

Ministepper a pistoni idraulici con elastici per il potenziamento di braccia, dorso e addome
Computer a 2 funzioni: tempo, calorie
Peso massimo utilizzatore 100 kg.

Ministepper with hydraulic rams and elastic bands for strengthening arms, back and abdomen

pg.13

57,50€

Art. OCST

Gradino step a 2 altezze (cm. 10-15)
con antiscivolo dim. cm. 68x30

Step adjustable at 2 different heights
(10-15 cm.) with anti-skid dim. 68x30 cm.



pg.14

Art. WBX-70

Power Tower

Attrezzo multifunzione ideato per l'allenamento intensivo di tutto il corpo senza l'utilizzo dei pesi
Tubolare a sezione quadrata da 5 cm.

Peso massimo utilizzatore 120 Kg.

Multi purpose tool for intensive body training without weights

341,50€

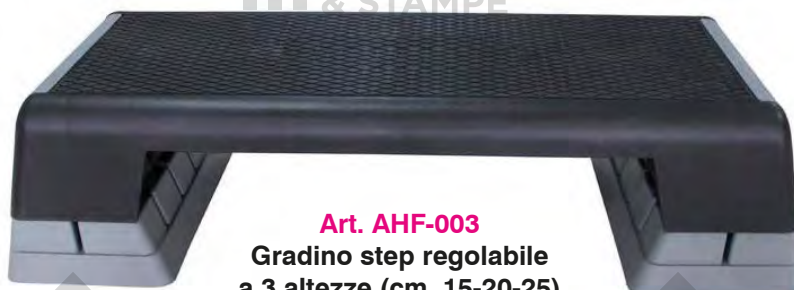

Art. AHF-003

Gradino step regolabile
a 3 altezze (cm. 15-20-25)

con superficie antiscivolo dim. cm. 89x39

Step adjustable at 3 different heights
(15-20-25 cm.)

with anti-skid surface dim. 89x39 cm.

138,00€



Art. BTM

Barra per trazioni
con fissaggio a parete
Exercise Bar

52,30€

pg.13



21,25€

Art. BTE

Barra Entroporta
Door Bar

● I numeri in giallo indicano la pagina di riferimento del listino Prezzi 2024-2025



Art. CGF350
Panca multifunzione
telaio in acciaio,
schienale regolabile
portata massima kg. 100
Weight lifting Bench

185,25€



220,00€ **Art. CGF450**
Panca pesi con supporti
bilanciere, telaio in acciaio,
schienale regolabile
peso max utilizzatore kg. 100
Weight lifting Bench
with barbell holders

FORNITURE ■■
& STAMPE

FORNITURE ■■
& STAMPE

ATTENZIONE: questi prodotti sono
concepiti esclusivamente per uso
home fitness, perciò la garanzia
non copre il loro utilizzo presso
palestre o centri sportivi



Art. WBX-85
Panca piana/90° Power Bench
rinforzata (abbinabile con Power Rack)
Power Bench

341,50€

pg.14



760,00€ **Art. GYM1000**
Stazione Multifunzione
dotata di torre per dorsali, pressa per
pettorali, attrezzo per le gambe, vogatore,
cuscino per bicipiti - carico massimo 60 Kg.
(pesi inclusi), 15 esercizi praticabili
peso massimo utilizzatore 120 Kg.
Multi purpose machine



368,50€ **Art. WBX-50**
Power Rack
Supporti per bilanciere
altezza e larghezza
regolabili
dotato di 2 rimessaggi
per dischi
peso massimo
caricabile 200 Kg.
Barbell racks

FORNITURE ■■
& STAMPE

FORNITURE ■■
& STAMPE

I numeri in giallo indicano la pagina di riferimento del Listino Prezzi 2024-2025

Art. ELX-1

464,00€

Ellittica con manubrio e pedali regolabili
Sistema frenante magnetico
8 livelli di intensità con regolazione manuale
Pulsazioni Hand Pulse
Schermo LCD
Funzioni: tempo, velocità, distanza, pulsazioni, calorie, recupero, odometro
Peso massimo utilizzatore 120 Kg.
Peso del volano 6 Kg.
Elliptical exercise Bike
7 function computer



pg.13

pg.14

Art. WBK-100

Panca per addominali massima portata Kg.110
dimensioni cm. 126x31x31
Abdominal bench maximum load 110 kg. dimensions 126x31x31 cm.



74,90€

ATTENZIONE: questi prodotti sono concepiti esclusivamente per uso home fitness, perciò la garanzia non copre il loro utilizzo presso palestre o centri sportivi

Art. GBX-100

399,00€

Panca ad inversione massima portata Kg.120
Rotazione schienale su 3 livelli predefiniti (20° - 40° - 60°) e rotazione libera - regolabile per altezza utente da cm. 147 a 198
dim. cm. 73x159x155/212
Inversion bench maximum load 120 kg.
Backrest rotation on 3 inclinations (20° - 40° - 60°) and free rotation adjustable for user height from 147 cm. to 198 cm. dim.cm.73x159x155/212



73,70€

Art. AB-CN1

AB Crunch Master richiudibile
AB Crunch Master foldable



89,00€

Art. GWM13

Pedaliera manuale utilizzabile da seduti per gli arti inferiori e appoggiata sul tavolo per gli arti superiori, peso 5 Kg. - con computer
Intensità sforzo regolabile
Cycling device for arm and leg exercises



178,00€

Art. GWE13

Pedaliera elettrica per la ginnastica passiva degli arti inferiori e superiori, velocità regolabile con telecomando, peso 6 Kg. - con computer
Cycling electric device for arm and leg exercises



I numeri in giallo indicano la pagina di riferimento del Listino Prezzi 2024-2025



Art. BFK-300

226,00€

Bicicletta da camera con freno magnetico
Regolazione dell'intensità manuale a 8 livelli
Volano da 4 Kg. - Computer a 6 funzioni: tempo, velocità, distanza, calorie, scan, pulsazioni con sensori Hand Pulse
Peso massimo utilizzatore 100 Kg. - Peso dell'attrezzo 20 Kg.
Cyclette Magnetic with 6 function computer

405,40€

Art. BRX-60

Bicicletta da camera con freno magnetico
Regolazione dell'intensità manuale a 8 livelli
Volano da 7 Kg. - Computer a 6 funzioni: tempo, velocità, distanza, calorie, odometro, pulsazioni con sensori Hand Pulse
Peso massimo utilizzatore 110 Kg.
Peso dell'attrezzo 24 Kg.
Cyclette Magnetic with 6 function computer



pg.13

ATTENZIONE: questi prodotti sono concepiti esclusivamente per uso home fitness, perciò la garanzia non copre il loro utilizzo presso palestre o centri sportivi

485,00€

Art. BRX-RC

Bicicletta da camera BRX-R 65 COMFORT con freno magnetico e sedile con schienale
Regolazione dell'intensità manuale a 8 livelli
Volano da 7 Kg.
Computer a 7 funzioni: tempo, velocità, distanza, calorie, pulsazioni con sensori Hand Pulse, odometro, scan
Peso massimo utilizzatore 110 Kg.
Peso dell'attrezzo 29,5 Kg.
Cyclette Magnetic with 7 function computer, seat adjusting system



583,00€

Art. SRX60

Spinning Bike
SRX60 EVO
con volano da 20 Kg.
Trasmissione a cinghia con pignone fisso
Sistema di frenaggio a tampone con feltri
Computer con LCD (velocità, tempo, distanza, calorie, odometro, pulsazioni)
Sella regolabile in orizzontale ed in altezza
Manubrio regolabile in altezza con appoggio per l'avambraccio
Portaborraccia
Peso massimo utilizzatore 125 Kg.
Peso dell'attrezzo 41 Kg.
Cyclette Magnetic with seat and handle-bar adjusting systems



15,50€

Art. 18220

Coprisella spinning
Seat cover
for spinning bike



I numeri in giallo indicano la pagina di riferimento del Listino Prezzi 2024-2025



**Senza motore.
Adatto per camminare,
non per correre**
With no engine. Suitable for
walking, not to run

327,00€

Art. TFK-MAG
TAPIS ROULANT MAGNETICO TFK-SLIM-MAG
piano di corsa cm.38x102
sistema di frenaggio magnetico su 8 livelli
doppio volano Kg.6 - peso massimo
utilizzatore Kg.100 - display LCD indicante velocità,
frequenza cardiaca, distanza, tempo,
consumo calorico, scan, rilevazione cardio Hand Pulse
Tapis roulant magnetic with no engine,
with multi function computer



756,00€

pg.14

Art. TFK-230
TAPIS ROULANT TFK-230
motore 1,75/2,75 HP DC - velocità 1-14 Km/h
inclinazione manuale - piano di corsa cm. 42x121
peso massimo utilizzatore 100 Kg.
1 programma libero, 64 preimpostati, display LED
indicante velocità, frequenza cardiaca, distanza,
tempo, consumo calorico, programma in esecuzione
Tapis roulant with 1,75/2,75 hp engine and
multi program computer

ATTENZIONE: questi prodotti sono
concepiti esclusivamente per uso
home fitness, perciò la garanzia
non copre il loro utilizzo presso
palestre o centri sportivi

1110,00€

Art. TFK-455
TAPIS ROULANT TFK-455 SLIM - salvaspazio
motore 2,00/3,00 HP DC - velocità 0,8-16 Km/h
inclinazione elettrica - piano di corsa cm.42,5x127
peso massimo utilizzatore 110 Kg.
1 programma libero, 12 preimpostati, display LCD
indicante velocità, inclinazione, frequenza cardiaca
tramite Hand Pulse, distanza, tempo,
consumo calorico, programma in esecuzione
Tapis roulant with 2/3 hp engine and multi program computer



299,75€

Art. TRXRC
**Vogatore Rower Compact - display LCD indicante
numero vogate, calorie, tempo, scan
regolazione sforzo su 12 livelli
peso max utilizzatore 110 Kg.**
Rower machine with computer



pg.14

I numeri in giallo indicano la pagina di riferimento del Listino Prezzi 2024-2025



23,30€

Art. CPGAN

Polsiere con gancio per esercizi alla barra per una presa più sicura e stabile grazie al gancio in acciaio rivestito in neoprene che si posiziona sotto al palmo della mano

Wristbands with hook for bar exercises for a safer and more stable grip thanks to the neoprene-coated steel hook placed under the palm of the hand

8,80€

Art. POLTA

Polsiere per trazioni dotate di anello e chiusura regolabile con velcro, estremamente resistenti e adatte a polsi di qualsiasi circonferenza

Wristbands for traction with ring and adjustable velcro closure, extremely durable and suitable for wrists of any size

pg.13



8,80€

Art. CAVTA

Cavigliere per trazioni dotate di anello e chiusura regolabile con velcro - comode e resistenti, si adattano a caviglie di qualsiasi circonferenza Ideali durante gli allenamenti di ginnastica, fitness e potenziamento muscolare

Ankle straps for traction with ring and adjustable velcro closure, comfortable and durable, they fit ankles of any size - ideal for gymnastics, fitness and muscle strengthening workouts



17,00€

Art. CIPT

Cuscino imbottito per bilanciere per eseguire lo squat in totale sicurezza e comodità diametro cm.8, lunghezza cm.40

Padded barbell cushion for performing squats with total safety and comfort diameter 8 cm, length 40 cm



60,25€

Art. 1FSF

Piastra antitrauma cm.100x100 spessore mm.10

in gomma riciclata con granulo ultrafine per proteggere il pavimento durante l'allenamento con attrezzi facile da posare e da pulire, antimuffa, antibatterica

Antitrauma plate 100x100 cm thickness 10 mm in ultrafine-grain recycled rubber to protect the floor during equipment training easy to install and clean, mold-resistant, antibacterial



6,15€

Art. AHF-165

Fascia da braccio porta smartphone Arm smartphone holder



7,30€

Art. E680

Bracciale porta oggetti in neoprene cm.14,5x8x2 Neoprene arm wallet



Numbers in yellow show the relevant page on 2024-2025 Price List

● I numeri in 10,00€ pagina di riferimento del Listino Prezzi 2024-2025

Art. SB099

TUBOLARE BARRET in microfibra 108 dinari

Prodotto tecnico brevettato come modello d'uso CEE - Made in Italy

Lascia traspirare la pelle e ripara dal freddo e dal vento

utilissimo in molteplici situazioni:

**durante e dopo gli allenamenti, durante gli incontri,
per sostenere la tua squadra, nel tempo libero, in moto etc.**



**Prodotto
bi-elastico
senza cuciture
bi-elastic
seamless**

Barret TUBOLAR HAT in microfiber - made in Italy patented
BTH lets your skin breath while protecting you from cold and wind
you can wear it during or after training, during the game, in your spare time,
to support your team, when riding your bike etc.

(pg.16)

utilizzabile come scaldacollo, foulard, bandana, fascia, passamontagna etc.



it can change shape from neck warmer to head band to foulard to bandana



**A differenza del comune
prodotto in pile, la
microfibra del Tubolare
Barret impedisce il
surriscaldamento e
l'eccessiva sudorazione
della pelle, grazie
alla sua speciale
traspirazione e
leggerezza**

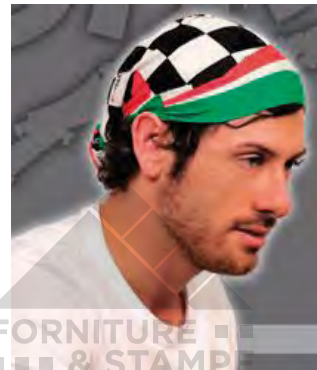

**PRODOTTO
TECNICO**

**TECHNICAL
PRODUCT**

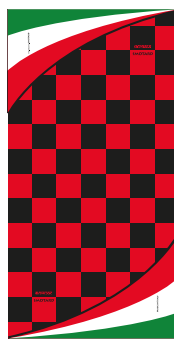
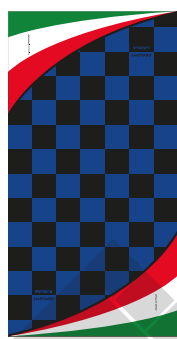
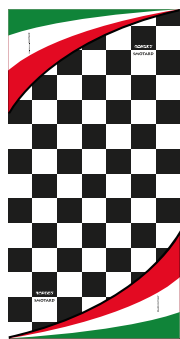

Colori disponibili:
bianco/nero, nero/azzurro,
rosso/nero, bianco/celeste,
bianco/rosso, giallo/rosso
(prodotto personalizzabile su
richiesta per ordine minimo di
100 pezzi, con spese
per elaborazione grafica da
definire)

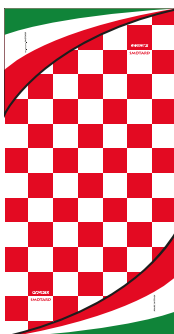
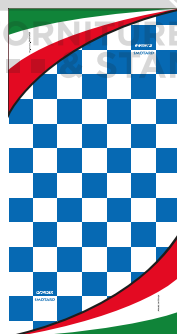
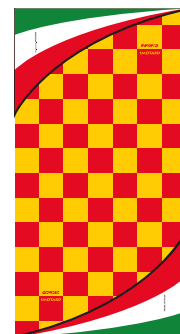

Colors available
as in the pictures
Barret tubolar HAT can be
personalized with your logo and
colors with a minimum order of
100 pieces (graphic work not
included in the price)

● I numeri in giallo indicano la pagina di riferimento del Listino Prezzi 2024-2025

CASACCHE - Mesh Shirts



Art. 088-A **4,70€**

Casacca traforata fluo taglia adulto

Fluo pierced training bib adult size - colors as in the picture



4,20€

Art. 088-B

Casacca traforata fluo per bambini fino a 9 anni

Fluo pierced training bib small size
(for children up to 9 years)
colors as in the picture



pg.16

10,00€

Art. 088-D

**Casacca traforata double-face fluo taglia adulto
colori rosso/blu - giallo/arancio**

Fluo pierced training bib double-face adult size
colors red/blue - yellow/orange



8,80€

Art. GIL01

Gilet steward

Colori giallo, arancio
Colors yellow, orange



● I numeri in giallo indicano la pagina di riferimento del Listino Prezzi 2024-2025

PANTALONCINI - CALZE - GUANTI
Shorts - Socks - Gloves

**** QUANTITÀ PER TAGLIA E COLORE MULTIPLA DI 5 PEZZI ****
Quantity by size and color multiple of 5 pieces



5,65€

Art. MF01
Pantaloncino da allenamento
100% poliestere
taglie dalla 3XS alla XXL
Colori: royal, bianco, bordeaux,
verde, navy, rosso, nero
(quantità per taglia e colore
multipla di 5 pz.)
Shorts in polyester
size from 3XS to XXL
Colors: white, red, royal,
blue, black, brown, green
(quantity by size and color
multiple of 5 pieces)



**Offerta sul
listino!**
Check on
price list!

3,18€

Art. IS005
Paio calze calcio con piede
Taglie

Bimbo: 29-34
Ragazzo: 35-40
Uomo: 41-46

Colori: royal, giallo limone, bianco,
bordeaux, navy, rosso, nero, verde
Pair of soccer socks sizes: Kid, JR, SR
Colors: white, red, royal, blue, black,
brown, lemon yellow, green



5,20€

Art. E6000
Scaldacollo in pile
taglia unica regolabile
colore navy o nero
Neck warmer in pile
one size fits all



7,30€

Art. IGUAS
Paio Guanti in acrilico
colore nero
misura junior e senior
con antiscivolo
Black acrylic Gloves
size junior and senior
anti-skid



5,65€

Art. E6013
Berretto in acrilico
nero, navy
taglia senior
Winter Cap
size senior

● I numeri in giallo indicano la pagina di riferimento del Listino Prezzi 2024-2025

TACCHETTI ED ACCESSORI PER SCARPE - Studs and Shoe accessories



Art. 265bis / 268bis / 270bis
Tacchetto alluminio conico
 mm. 14-17-19
 conf. 100 pz. per misura
 Conical aluminium Stud
 14-17-19 mm.
 100 piece pack



Art. BACS
Blister 12 tacchetti in alluminio conici senza rondelle
 (8 x mm. 14 + 4 x mm. 17)
 12 piece pack conical aluminium studs without washers



Art. BACSC
Blister 12 tacchetti in alluminio conici con rondelle
 (8 x mm. 14 + 4 x mm. 17)
 12 piece pack conical aluminium studs with washers

pg.14

pg.15



Art. 262/263/264/265/266/267/268/269/270
Tacchetto alluminio conico tornito punta rinforzata
 mm. 11-12-13-14-15-16-17-18-19
 conf. 100 pz. per misura
 Milled conical aluminium Stud
 100 piece pack

Art. PR11 / PR13 / PR17
Tacchetto alluminio conico tornito punta rinforzata
 mm. 11-13-17
 conf. 100 pz. per misura (ad esaurimento scorte)
 Conical aluminium Stud reinforced tip 11-13-17 mm.
 100 piece pack (until available in stock)



Art. A11 / A13 / A15 / A17
Tacchetto alluminio conico tornito Argentinos superleggero Serie A
 mm. 11-13-15-17
 Milled conical aluminium Stud ultra-light Serie A
 11-13-15-17 mm.



Art. AL09F / AL11F / AL13F / AL15F
Tacchetto alluminio conico tornito Argentinos superleggero Serie A con filettatura maggiorata (Adidas)
 mm. 9-11-13-15
 Milled conical aluminium Stud ultra-light Serie A with increased thread (Adidas) 9-11-13-15 mm.

● I numeri in giallo indicano la pagina di riferimento del Listino Prezzi 2024-2025

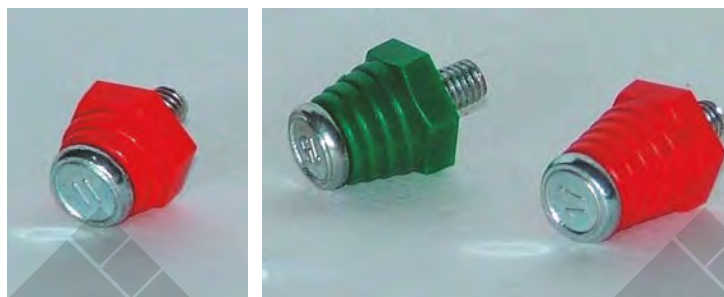

Art. 292 / 293 / 294 / 294bis

Tacchetto in nylon conico punta rinforzata in alluminio mm.11-13-15-17, conf. 100 pz. per misura (ad esaurimento)

Conical Nylon stud with reinforced tip - 100 piece pack (until available)

pg.15



Art. 231 / 232 / 233
Tacchetto in nylon punta rinforzata in metallo mm. 11-13-16 conf. 100 pz. per misura
Nylon stud with reinforced tip 11-13-16 mm. 100 piece pack

Art. 230
Blister 12 tacchetti in nylon punta rinforzata in metallo mm. 11-13-16
12 piece pack nylon studs with reinforced metal tip 11-13-16 mm.



Art. M204 / M205
Tacchetto in nylon monocolore mm. 13 / 16 conf. 100 pz. per misura
Nylon Stud mm. 13 / 16 - 100 piece pack



Art. M203
Blister 12 tacchetti in nylon monocolore 8 x mm. 13 + 4 x mm. 16 (nero, rosso, bianco)
12 piece pack nylon studs single color (black, red, white)



Art. 35M12

Tacchetto gomma base stretta mm. 12 conf. 100 pz.
Narrow Base Rubber Stud mm. 12 - 100 piece pack

Art. 35M14

Tacchetto gomma base stretta mm. 14 conf. 100 pz.
Narrow Base Rubber Stud mm. 14 - 100 piece pack



Art. 072.11.13

Confezione blister 12 Tacchetti gomma base larga per terreni gelati (8 x mm. 11+ 4 x mm. 13)
Wide Base Rubber Stud - for icy ground 12 piece pack

Art. 302

Base filettata in alluminio mm. 7, 8 (mm.10, 12 ad esaurimento)
Threaded aluminium base 7, 8 mm. (10, 12 mm. until available)
conf. 50 pz. per misura - 50 piece pack



Art. 314 Rondella in alluminio - conf. 100 pz.
Aluminium washer - 100 piece pack



Art. 302G

Base filettata in alluminio mm. 17 (mm.13 ad esaurimento) - conf. 50 pz. per misura
Threaded aluminium base 17 mm. (13 mm. until available) - 50 piece pack



Art. CHAZ

Chiave in acciaio zincocromata
Stud Key

● I numeri in giallo indicano la pagina di riferimento del Listino Prezzi 2024-2025



6,35€

Art. 317 / 318
Paio tendiscarpe a molla,
misura 40-42 / 43-45
 Shoe stretchers with spring,
 size 40-42 / 43-45

pg.15

pg.16

FORNITURE ■ ■ ■ & STAMPE

FORNITURE ■ ■ ■ & STAMPE

FORNITUR ■ ■ ■ & STA

1,69€

1,85€



150 cm 150 cm
bianco e nero colori

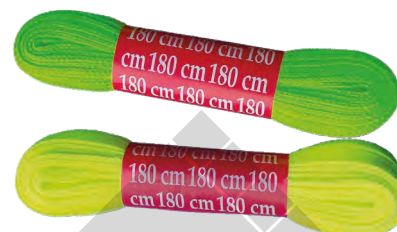

1,35€

1,55€

120 cm 120 cm
bianco e nero colori

Art. 326 / 326FL / 327 / 327FL / 328 / 328FL

Paio lacci per scarpe cm.120-150-180
colori nero, bianco, giallo fluo, verde fluo, arancio fluo
 Pair of shoe laces 120-150-180 cm. long
 colors: black, white, fluo yellow, fluo green, fluo orange

2,05€

2,15€

180 cm 180 cm
bianco e nero colori



7,80€

Art. ALZ.SP
Paio Alzatacco in gel
taglia 1 donna
taglia 2 uomo
 Gel under heel softeners
 woman and man sizes

Art. SOL.SP
Paio solette in gel
profumate ritagliabili
 Gel Insoles

11,10€



4,50€

Art. 21654
Paio solette
Spugna Sport
 Sport Insoles

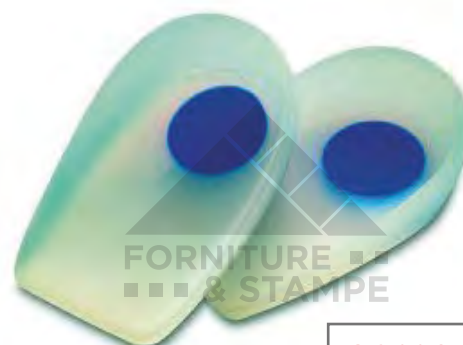

36,00€

Art. E6694
Paio Alzatacco in silicone
misura S (33/36) - M (37/40)
L (40/44) - XL (44/48)
 Silicone under heel softeners
 various sizes

● I numeri in giallo indicano la pagina di riferimento del listino Prezzi 2024-2025



Art. S489 **3,50€**
Spazzola in setola naturale
Shoe Brush

30,80€

Art. 238.1
Grasso Aquila Kg.1
Aquila Grease for shoes
1 Kg.

6,80€

Art. 238
Grasso Aquila ml. 100
Aquila Grease for shoes
100 ml.

● pg.15

Art. 34071A
Spray impermeabilizzante
Spray waterproofing



11,50€

Art. D122X
Spray Dilato ml. 200
ammorbidente
Spray to soften leather
soccer shoes



3,70€

Art. SL.S
Spugna lucidascarpe
(ad esaurimento)
Shoe polisher sponge
(until available)



Art. TE.540.01
Zerbino pulisciscarpe
in plastica con ventose
dimensioni cm.35x27
Shoe cleaning device
in plastic with suckers
dimension 35x27 cm.

90,50€

● pg.16



271,00€ **Art. FA270**

Macchina lavascarpe con 4 spazzole sostituibili
getti incrociati regolabili ad alta pressione
completo di poggiamani e 4 fori di fissaggio a terra
in dotazione fascetta in acciaio per collegamento tubo
mm. 15x21 (non incluso) alla rete idrica
Shoe washing device - high pressure crossed water jets
iron frame with handles, replaceable brushes
easy fixing to the floor with 4 holes

● I numeri in giallo indicano la pagina di riferimento del Listino Prezzi 2024-2025

PARASTINCHI - GUANTI PORTIERE - Shinguards - GK Gloves



8,75€

Art. PSCV
Paio parastinchi
senza cavigliera
misura adulto
e bambino
Pair of shinguards
without ankle protection
junior and senior size



9,35€

Art. IS30HS
Paio parastinchi
senza cavigliera
misura S-M-L
Pair of shinguards
without ankle
protection
size S-M-L

pg.16



Art. PBC

Paio parastinchi
con cavigliera
misura adulto
Pair of shinguards
with ankle protection
senior size

5,90€



pg.16

19,90€

Art. F30BG
Paio Guanti portiere misure da 4 a 11
Pair of Goalkeeper Gloves size from 4 to 11

I colori dei guanti raffigurati nelle immagini possono variare

● I numeri in giallo indicano la pagina di riferimento del Listino Prezzi 2024-2025

FASCE CAPITANO - Captain's Armbands



Art. 150 **3,10€**
Fascia capitano elastica misura adulto
 Elastic Captain's armband size adult

Art. 150.B **2,90€**
Fascia capitano elastica misura bambino
 Elastic Captain's armband size children

pg.17



Art. 150F **3,30€** **Fascia capitano elastica misura adulto colore giallo fluo o arancio fluo**
 Elastic Captain's armband adult size colors: fluo yellow and fluo orange



3,40€

Art. 150V / 150V.B

3,00€

Fascia capitano con velcro, taglia adulto / bambino
Modello Champions colori bianco, rosso, giallo, verde, blu, fucsia, arancio - h. cm. 6,5
 Captain's armband adjustable length 6,5 cm. height size adult / children colors: white, red, yellow, blue, green, fuchsia, orange



3,80€

Art. 150V.9

Fascia capitano con velcro, taglia adulto
colori: bianco, rosso, giallo fluo, verde, blu e arancio fluo - h. cm. 9
 Captain's armband adjustable length, 9 cm. height size adult - colors: white, red, fluo yellow, blue, green, fluo orange



Art. 150V.9N

3,70€

Fascia capitano neutra con velcro, taglia adulto
h. cm. 9 - colori: giallo fluo, arancio, bianco, rosso, verde, blu
 Captain's armband with no "C" printed adjustable length, 9 cm. height size adult - colors: fluo yellow, orange, white, red, green, blue



Art.150N

3,70€

Fascia nera lutto
 Black mourning armband

I numeri in giallo indicano la pagina di riferimento del Listino Prezzi 2024-2025

NUMERI TERMOSALDABILI Numbers for Uniforms

Colori disponibili: bianco, giallo, rosso, verde, royal, blu, granata, nero, oro, argento
Available colors: white, yellow, red, green, royal, blue, brown, black, gold, silver

Art. PN23



Art. PN18



Art. PN10



pg.17

1,45€

Art. PN23

Numeri termosaldabili Omega h. 23 cm.
numeri singoli (da 0 a 9)
Single numbers for sport uniforms
Omega series 23 cm. height
(from 0 to 9)

1,45€

Art. PN18

Numeri termosaldabili Omega h. 18 cm.
numeri singoli (da 0 a 9)
Single numbers for sport uniforms
Omega series 18 cm. height
(from 0 to 9)

0,78€

Art. PN10

Numeri termosaldabili Omega h. 10 cm.
numeri singoli (da 0 a 9)
Single numbers for sport uniforms
Omega series 10 cm. height
(from 0 to 9)



TEMPERATURA

DI APPLICAZIONE 140/145 °C

TEMPO DI APPLICAZIONE

15 SECONDI

MAXIMUM TEMPERATURE 145 °C

MAXIMUM 15 SECOND PRINT

1,30€

Art. PN4

Numeri termosaldabili Omega h. 4 cm.
con cerchio (da 1 a 100)
colori bianco, blu o nero
Numbers for sport uniforms
Omega series 4 cm. height with circle
(from 1 to 100)
black, blue or white color

● I numeri in giallo indicano la pagina di riferimento del Listino Prezzi 2024-2025

MATERASSINI - Mats

10,45€

Art. 044
Materassino pieghevole
alta densità
cm. 180x50x0,7
 Folding foam Mat
 high density
 180x50x0,7 cm.

12,20€

Art. 044-A
Materassino pieghevole
alta densità
cm. 180x60x0,7
 Folding foam Mat
 high density
 180x60x0,7 cm.

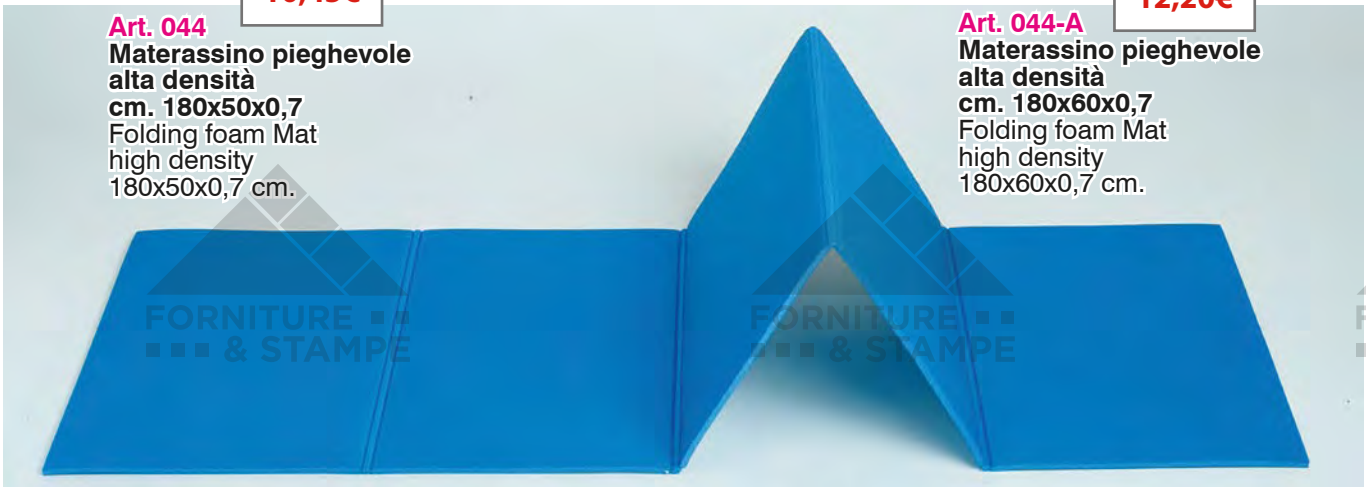

pg.17

8,00€

Art. 044-R
Materassino arrotolabile
alta densità
cm. 180x50x0,6
 Rolled foam Mat
 high density 180x50x0,6 cm.

18,90€

Art. AS803
Materassino Exercise Mat
imbottito e serigrafato cm. 180x60x2,5
 PVC Mat 180x60x2,5 cm.



14,00€

Art. 30924
Materassino Yoga arrotolabile
cm. 172x60x0,4
 Rolled Yoga Mat 172x60x0,4 cm.



● I numeri in giallo indicano la pagina di riferimento del Listino Prezzi 2024-2025

LAVAGNE TATTICHE PER CALCIO E CALCETTO - Tactical Boards for Football and Futsal



94,50€

Art. 087
Lavagna magnetica cm. 60x90 cancellabile con cornice metallica

Tactical board 60x90 cm. magnetic and erasable with metal frame

Art. 087.BO

Borsa per lavagna Art. 087

26,30€



Art. PM60

Serie pedine magnetiche di ricambio per lavagna Art. 087

Spare magnetic pieces for tactical board Art. 087

8,75€

● pg.18

86,75€

Art. 090RIC

Ricambio 100 fogli cm.70x100 per lavagna Art. 090 (treppiede escluso)

100 spare sheets for board Art. 090 (tripod not included)



524,00€

Art. M087TP

Treppiede di sostegno in acciaio verniciato per lavagna Art. 087 (lavagna esclusa)

Painted steel tripod for tactical board Art. 087 (board not included)



253,00€

Art. 090

Lavagna su treppiede con 100 fogli cm.70x100 (non cancellabili)

Board on tripod with 100 sheets 70x100 cm. (not erasable)

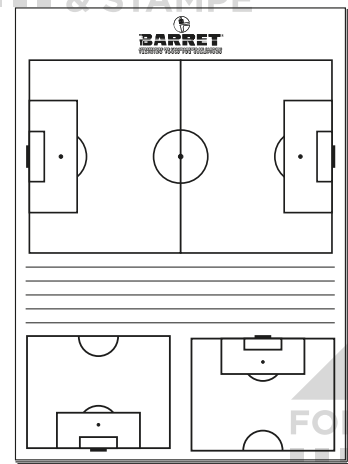

Art. BL50F
Blocco con 50 fogli formato A4 (non cancellabili)
Block with 50 A4 sheets (not erasable)

12,20€

I numeri in giallo indicano la pagina di riferimento del Listino Prezzi 2024-2025

47,75€



Art. 05030425

Set 25 fogli adesivi cm.80x100 applicabili a porte e pareti, rimuovibili e cancellabili (ideale per partite in trasferta)
 Set of 25 adhesive sheets 80x100 cm. on a roll, easily separable. Due to the electrostatic charge, it can be hung on any door or wall and removed several times without leaving any trace. Ideal for away games. Either permanent or non permanent markers work for writing

pg.18

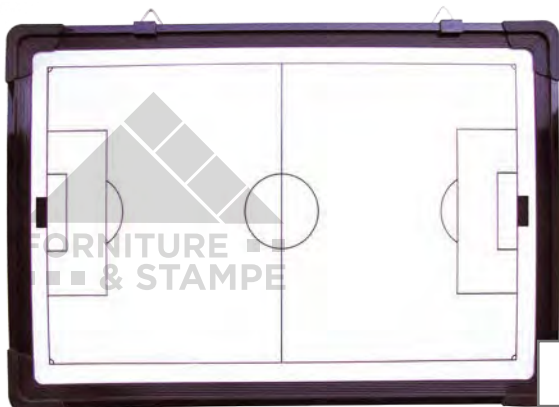

Lato A
Side A

29,00€



Lato B
Side B

Art. 089

Lavagna magnetica bifacciale cancellabile con borsa cm. 45x30
 2 face Tactical Board magnetic and erasable 45x30 cm. with bag

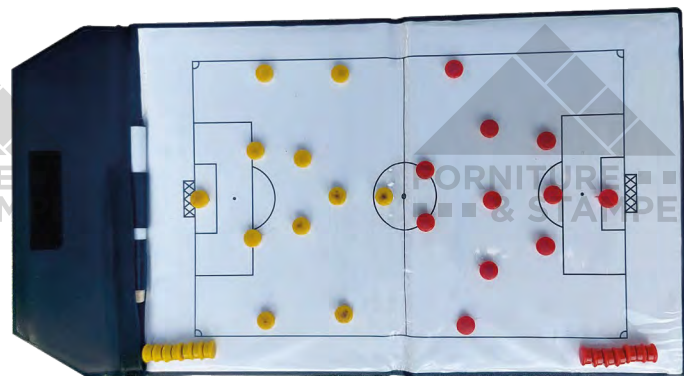

25,15€

Art. 089-P

Lavagna magnetica cancellabile pieghevole cm. 46x25
 Foldable Tactical Board magnetic and erasable 46x25 cm.

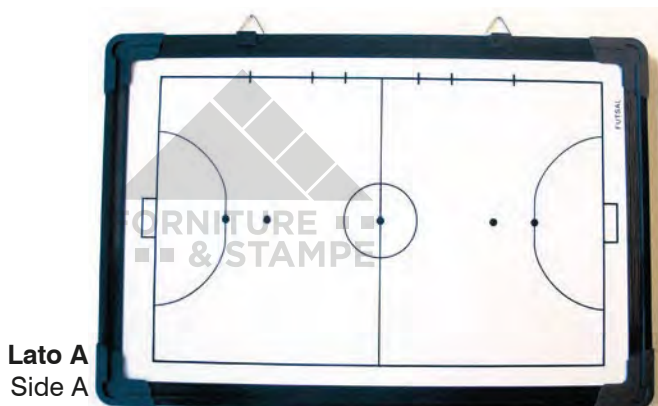

Lato A
Side A



Lato B
Side B

Art. 089CM

29,00€

Lavagna Tattica Calcio bifacciale magnetica e cancellabile cm. 45x30
 2 face Futsal Tactical Board magnetic and erasable 45x30 cm.

pg.18

● I numeri in giallo indicano la pagina di riferimento del Listino Prezzi 2024-2025

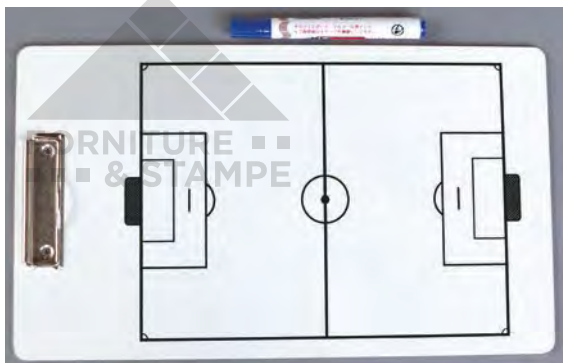

Art. 089-A
Lavagna bifacciale cancellabile cm. 40x23
 2 face Tactical Board erasable, 40x23 cm.

13,50€



Art. CSRK
Lavagna Tattica magnetica cancellabile
con block-notes cm. 40x23
 Magnetic Tactical Board 40x23 cm. erasable

pg.18

21,25€

URE ■ ■
 TAMPE

FORNITURE ■ ■
 ■ ■ ■ & STAMPE

FORNITURE ■ ■
 ■ ■ ■ & STAMPE

pg.18

13,50€
Art. 089-C
Lavagna Tattica
Calcetto bifacciale
cancellabile
cm. 40x23
 2 face Futsal
 Tactical Board 40x23
 cm. erasable

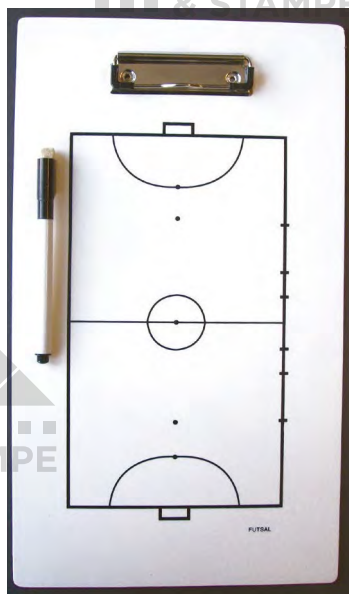

Art. PM
Serie pedine magnetiche
di ricambio per lavagne
di dimensioni ridotte
 Spare magnetic pieces
 for small tactical boards

FORNITURE ■ ■
 ■ ■ ■ & STAMPE

FORNITURE ■ ■
 ■ ■ ■ & STAMPE

FORNITURE ■ ■
 ■ ■ ■ & STAMPE

Art. PAL-B
Pal Block - blocco
tascabile con 25 pagine
copertina cancellabile
 Pocket block-notes
 25 pages with erasable cover

9,55€



URE ■ ■
 TAMPE

FORNITURE ■ ■
 ■ ■ ■ & STAMPE

FORNITURE ■ ■
 ■ ■ ■ & STAMPE

Art. 18330
Lavagna magnetica cancellabile pieghevole
Multisport (Calcio, Basket, Volley, Rugby,
Badminton, Tennis, Floorball, Pallamano,
Hockey su ghiaccio)
dimensioni cm. 32x22
 Multisport Foldable Tactical Board magnetic and
 erasable 32x22 cm.

20,50€

pg.18



● Numbers in yellow show the relevant page on 2024-2025 Price List

● I numeri in giallo indicano la pagina di riferimento del Listino Prezzi 2024-2025



140 pagine



Only in Italian

36,00€

Art. DALT

DIARIO ALLENAMENTO

per l'allenatore di calcio con lavagna tattica

Lo strumento ideale per programmare e registrare durante il corso della stagione tutto ciò che riguarda la preparazione fisica generale, specifica e speciale, i test di valutazione, la preparazione psico-tattica teorica e pratica, la preparazione psico-cinetica, gli esercizi tecnico-tattici, il riscaldamento, il defaticamento e la preparazione post-infortunio della Vostra squadra di calcio e dei singoli giocatori che la compongono. E' inoltre fondamentale per l'annotazione di tutto ciò che riguarda le partite amichevoli e le partite di campionato, in relazione agli avversari da incontrare.

Il diario è corredato di una retrocopertina pieghevole utilizzabile come lavagna tattica cancellabile a 3 facce



pg.18

Con lavagna cancellabile sulla retrocopertina



● Numbers in yellow show the relevant page on 2024-2025 Price List

I numeri in giallo indicano la pagina di riferimento del Listino Prezzi 2024-2025

GHIACCIO - TAPE - CREME - OLI
Ice - Tape - Creams - Oils



7,60€

Art. 164
Ghiaccio spray
ml. 400
Ice spray 400 ml.



1,25€

Art. 165
Ghiaccio
in busta monouso
Ice in envelope



6,35€

Art. NE2.5
Nastro economico cm. 2,5x13,7 mt
Tape cm. 2.5x13,7 mt.

12,10€

Art. NE5
Nastro economico cm. 5x13,7 mt
Tape cm. 5x13,7 mt.

6,65€

Art. N2.5
Nastro tipo Strappal cm. 2,5x10 mt
Tape Strappal cm. 2,5x10 mt.

13,15€

Art. N5
Nastro tipo Strappal cm. 5x10 mt
Tape Strappal cm. 5x10 mt.



6,15€

Art. 9254
Salvapelle
Skin Protection



7,80€

Art. IDNC38
Nastro adesivo colorato fermacalze
cm. 3,8x9,14 mt.
colori: rosso, nero, blu, verde e giallo
Coloured Tape stop stockings
in red, black, blue, green and yellow



17,90€

Art. TPG09
Fraplast cm. 8 (Tensoplast)

56,35€

Art. IPT02
Forbice
taglia taping
in acciaio inox
Scissors for taping



38,80€

Art. IPT01
Cutter taglia bendaggi
Cutter for bandaggs



11,50€

Art. T255
Kinesio Tape
Kinesio Tape

Numbers in yellow show the relevant page on 2024-2025 Price List

● I numeri in giallo indicano la pagina di riferimento del Listino Prezzi 2024-2025



37,50€

Art. ONC
Olio riscaldante 500 ml
stimola la circolazione,
tonifica la muscolatura,
previene le lesioni muscolari
microtraumatiche
Oil 500 ml
for muscle warm up, stimulating
blood circulation
and preventing micro injuries



37,50€

Art. CNC
Crema riscaldante 250 ml
stimola la circolazione,
tonifica la muscolatura,
previene le lesioni muscolari
microtraumatiche
Cream 250 ml
for muscle warm up, stimulating
blood circulation and preventing
micro injuries



14,90€

Art. IRVF
Vaselina filante
per curare le zone della pelle a
maggiore sollecitazione
Vaseline avoiding skin problems



42,40€

Art. IRFA
Fango argilla per impacchi
dopo distorsioni,
per assorbimento ematomi
Special mud to be used after
injuries (i.e. sprained ankles)
and to absorb bruises

pg.18



37,50€

Art. IJGE
Crema Gel Jesic
coadiuvante per
infiammazioni, contusioni
e lesioni dell'apparato
muscolare
Cream Gel Jesic
for treating minor injuries
and sore muscles

37,50€

Art. T10R
Gel
freddo
refrigerante
immediato su
contusioni o
strappi muscolari
Cold Gel for
immediate
application on
bruises and sore
muscles

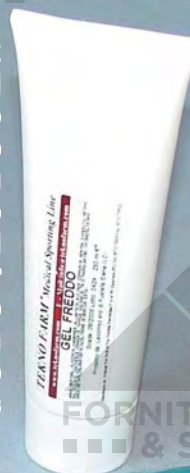

7,40€

Art. T17G
Cuscinetto
in gel
dim. cm.27x12
(effetto freddo
ed effetto caldo)
Gel Pillow
27x12 cm.
(both for cold
and hot therapy)



Art. T17G

● I numeri in giallo indicano la pagina di riferimento del Listino Prezzi 2024-2025

BORRACCE - Water Bottles



2,93€

Art. K8
Borraccia da 1 litro
in plastica
 1 liter plastic Water Bottle

pg.17

Certificate
 per uso
 alimentare
 Food grade
 certified



2,25€

Art. B500ML
Borraccia
da ½ litro
in plastica
 ½ liter plastic
 Water Bottle



17,00€

Art. BAL1
Borraccia da 1 litro
in alluminio
 1 liter aluminium Water Bottle



10,90€

Art. BAL05
Borraccia da ½ litro
in alluminio
 ½ liter aluminium Water Bottle



21,25€

Art. BTA05
Borraccia termica
da ½ litro in acciaio
mantiene costante la temperatura
del liquido (sia caldo che freddo)
 ½ liter thermic steel Water Bottle
 keeps the liquid temperature
 unchanged

Certificate
 per uso
 alimentare
 Food grade
 certified



46,60€

Art. IRTT
Distributore termico 6 litri
con rubinetto
 Thermos 6 liter with tap

● Numbers in yellow show the relevant page on 2024-2025 Price List

● I numeri in giallo indicano la pagina di riferimento del Listino Prezzi 2024-2025



7,60€

Art. 308.C

**Cestello per 6 Borracce
in plastica**

Holder for 6 plastic
water bottles

pg.17



Art. 306

**Kit 6 Borracce
da 1 litro in plastica con cestello**
Kit 6 one liter plastic water bottles
with holder

25,15€



Art. C6B

**Cestello per 6 Borracce
in plastica pieghevole**
Foldable Holder for 6
plastic water bottles

15,00€



Art. KIT6

**Kit 6 Borracce da 1 litro
in plastica con cestello pieghevole**
Kit 6 one liter plastic water bottles
with foldable holder

32,55€



Art. OC8

**Cestello per 8 Borracce
in plastica pieghevole**
Foldable Holder for 8
plastic water bottles

16,55€



Art. K8S6

**Kit 8 Borracce
da 1 litro in plastica
con cestello pieghevole**
Kit 8 one liter plastic water bottles
with foldable holder

39,95€

● Numbers in yellow show the relevant page on 2024-2025 Price List

● I numeri in giallo indicano la pagina di riferimento del Listino Prezzi 2024-2025

BANDIERINE - Flags



Art. 074
 Kit completo
 4 paletti
 calcio d'angolo
 con snodo
 in PVC Ø mm.32
 (bandierine colore
 giallo o rosso)
 Kit 4 complete
 flexible Corner
 Poles
 in PVC Ø 32 mm.
 (yellow or red flags)

95,50€



Art. 074RP
 Kit completo
 4 paletti
 calcio d'angolo
 con snodo
 rinforzati con tubo
 esterno in
 polipropilene
 Ø mm.40
 (bandierine colore
 giallo o rosso)
 Kit 4 complete
 flexible Corner
 Poles reinforced
 with polypropylene
 pipe Ø 40 mm.
 (yellow or red flags)

118,90€

FORNITURE ■ ■ ■
 ■ ■ ■ & STAMPE

FORNITURE ■ ■ ■
 ■ ■ ■ & STAMPE

pg.18



**Non utilizzabili
 per partite ufficiali**
 Not for official
 matches

Art. 073
 Kit completo
 4 paletti calcio d'angolo
 in PVC Ø mm.32
 (bandierine colore giallo o rosso)
 Kit 4 complete Corner Poles
 in PVC Ø 32 mm.
 (yellow or red flags)

53,60€



Art. 368

Art. 368 Kit ricambi
 4 Bandierine calcio d'angolo
 colore giallo o rosso
 Kit of 4 spare Corner Flags
 yellow or red color

15,10€

FORNITURE ■ ■ ■
 ■ ■ ■ & STAMPE

● Numbers in yellow show the relevant page on 2024-2025 Price List

● I numeri in giallo indicano la pagina di riferimento del Listino Prezzi 2024-2025



Art. 075

19,50€



Art. 076

19,50€

Art. 075 / 076

Coppia Bandierine segnalinee gialle / a scacchi con aste in plastica
Pair of linesman's Flags yellow / checked with plastic sticks

pg.19



Art. 367-G

7,80€

Art. 367-S

7,80€

Art. 367-G / 367-S

Kit ricambi 2 Bandierine segnalinee gialle / a scacchi
Kit of 2 spare linesman's Flags yellow / checked



24,40€

Art. 13ALC

Coppia Bandierine segnalinee a scacchi fluorescenti con aste in alluminio e custodia
Pair of linesman's Flags fluorescent with aluminium sticks and holder



pg.19

Art. 172

1130,00€

Coppia Bandierine segnalinee elettroniche complete di ricevitore e borsa
Pair of electronic linesman's Flags complete with signal receiver and bag

● Numbers in yellow show the relevant page on 2024-2025 Price List

● I numeri in giallo indicano la pagina di riferimento del listino Prezzi 2024-2025

ACCESSORI ARBITRO - Referee's accessories

7,00€



Art. 078
Fischio FOX 40 Classic senza pallina
nero o colorato
Whistle FOX 40 Classic

FORNITURE ■■■ & STAMPE

FORNITURE ■■■ & STAMPE

FORNITURE ■■■ & STAMPE

10,70€

Art. 078PD
Fischio arbitro senza pallina
FOX 40 Classic CMG nero o
colorato con imboccatura
anatomica e cordino
Whistle FOX 40 Classic CMG
cushioned mouth grip
(cord is included)

pg.19



15,40€

Art. 078SK
Fischio FOX 40 SONIK BLAST
CMG con cordino - vari colori,
con due camere sonore
Whistle FOX 40 SONIK BLAST
CMG with cord, various colors

FORNITURE ■■■ & S



4,20€

Art. 078CH

Fischio senza pallina nero o colorato con cordino in confezione blister
Plastic whistle various colors with cord

FORNITURE ■■■ & S

pg.19



2,35€

Art. 228C
Fischio in plastica
nero con cordino
Plastic black whistle
with cord

1,25€

Art. 228
Fischio in plastica nero
senza cordino
Plastic black whistle
without cord



pg.19

Art. 079C
Fischio cromato
con cordino
Chromed brass
whistle with cord

3,50€



29,00€

Art. FEFOX
Fischio elettronico
FOX 40 con cordino
potenza 100 dB
Electronic FOX 40
whistle with cord

FORNITURE ■■■ & S

● I numeri in giallo indicano la pagina di riferimento del Listino Prezzi 2024-2025



1,00€

Art. 080
Cordino Lanyard
colore nero
Nylon
whistle cord Lanyard
black color

pg.19



3,10€

Art. F40CAP
Cordino FOX antipanico
regolabile, vari colori
FOX whistle cord adjustable
various colors



1,25€

Art. 9816
Laccino regolabile
per fischietto arbitro
Adjustable wrist lace
for referee's whistle



53,60€

Art. KCPFOX
Kit cronometro da polso e
fischietto FOX 40 Sonik Blast
con cordino
Kit wrist Chronometer with FOX
40 Sonik blast whistle with cord



17,90€

Art. RPC
Raccogliatore ad anelli cm.18x15
per cartellini giocatori
con 20 buste trasparenti
Ring binder 18x15 cm. for players'
cards with 20 transparent envelopes



5,95€

Art. 081F Coppia cartellini
giallo e rosso con custodia,
matita e tabellino gara
Yellow and red cards with holder,
pen and game note card

4,50€

Art. RPCRIC
Ricambio 10 buste trasparenti per
raccogliatore ad anelli Art. RPC
Set of 10 spare envelopes for Art. RPC

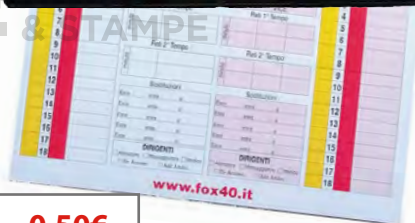

0,50€

Art. ZAFN
Tabellino gara di ricambio
per Art. 081F
Spare game note card for Art. 081F



11,50€

Art. GR15
Coppia cartellini
giallo e rosso
riscrivibili con pennarello
(cancellabili con alcol)
Rewritable yellow
and red cards with pen
(erasable with alcohol)

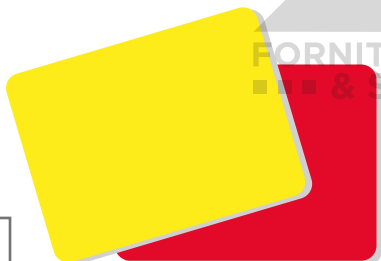

1,95€

Art. RYC02
Set 1 cartellino arbitro giallo
e 1 cartellino arbitro rosso
Set 1 yellow and 1 red card for referee

pg.19



1,00€

Art. RCB
Cartellino arbitro blu
Blue referee card



5,65€

Art. 880147
Moneta per arbitro
in plastica
rosso/nera
Referee's coin

● I numeri in giallo indicano la pagina di riferimento del Listino Prezzi 2024-2025

SEGNALATORI MANUALI ED ELETTRONICI PER SOSTITUZIONI Manual and electronic Substitution Boards

22,60€

Art. 071
Serie numeri cambio giocatori (da 1 a 25) senza manico
Numbers for substitution (from 1 to 25) without handle



27,10€

Art. 072
Serie numeri cambio giocatori (da 1 a 25) con manico
Numbers for substitution (from 1 to 25) with handle



pg.20

42,40€

Art. E6230
Segnalatore bifacciale economico per cambio giocatori manuale cm.43x38
Substitution indicator 1 piece 2 sides

Lato A
Side A



Lato B
Side B



Lato B
Side B



Lato A
Side A

91,50€

pg.20

Art. C00937
Segnalatore bifacciale per cambio giocatori manuale fluorescente - cm.40x32 base in plastica lucida
Substitution indicator fluorescent 1 piece 2 sides

Art. FINOUT4

Tavoletta elettronica bicolore, monofacciale a 4 cifre (2+2) - led verdi per giocatore entrante led rossi per giocatore uscente, completa di caricabatteria - dim. cm. 58x38x2,7 kg. 2,2
4 Digit Electronic Substitution Board 1 side 2 color leds (red and green) cm.58x38x2,7 Kg. 2,2 with battery charger

672,00€



Art. F292-30

Valigetta cm. 61x40x8 per Art. FINOUT4 e FINOUT8
Case 61x40x8 cm. for Art. FINOUT4 and FINOUT8

85,00€

Art. FINOUT8

Tavoletta elettronica bicolore, bifacciale a 4 cifre (2+2) - led verdi per giocatore entrante led rossi per giocatore uscente, completa di caricabatteria - dim. cm. 58x38x2,7 kg. 2,25
4 Digit Electronic Substitution Board 2 sides 2 color leds (red and green) 58x38x2,7 Kg. 2,25 with battery charger

955,00€

pg.20

● I numeri in giallo indicano la pagina di riferimento del Listino Prezzi 2024-2025

910,00€

Art. 065-EC

Tavoletta elettronica bifacciale, bicolore DELTA 2FE1 cm.46x33x1,8 Kg.1,5 completa di valigetta e caricabatteria
 4 digit Electronic substitution Board
 2 sides - 2 color leds (red and green)
 bag and battery charger included

FORNITURE ■ ■ ■ ■ ■
 ■ ■ ■ ■ ■ & STAMPE



**UEFA
 APPROVED**



**Nuova tastiera
 new keyboard**

FORNITURE ■ ■ ■ ■ ■
 ■ ■ ■ ■ ■ & STAMPE



FORNITURE ■ ■ ■ ■ ■
 ■ ■ ■ ■ ■ & STAMPE

FORNITURE ■ ■ ■ ■ ■
 ■ ■ ■ ■ ■ & STAMPE

1363,00€

pg.20

Art. D2FE

Tavoletta elettronica bifacciale, bicolore DELTA 2FE completa di valigetta e caricabatteria cm. 64,5x39x2,5 kg. 2,8
 4 digit UEFA Electronic substitution Board
 2 sides - 2 color leds (red and green)
 bag and battery charger included

**UEFA
 APPROVED**

**UEFA
 APPROVED**

2652,00€

Art. 065-F

Tavoletta elettronica approvata UEFA/FIFA bifacciale, bicolore a 4 cifre DELTA 2F completa di valigetta e caricabatteria led rossi e verdi - cm. 64x39x3 kg. 3
 4 digit UEFA/FIFA Electronic substitution Board 2 sides - 2 color leds (red and green)
 bag and battery charger included

FORNITURE ■ ■ ■ ■ ■
 ■ ■ ■ ■ ■ & STAMPE

FORNITURE ■ ■ ■ ■ ■
 ■ ■ ■ ■ ■ & STAMPE

FORNITURE ■ ■ ■ ■ ■
 ■ ■ ■ ■ ■ & STAMPE



● Numbers in yellow show the relevant page on 2024-2025 Price List

FORNITURE ■ ■ ■ ■ ■
 ■ ■ ■ ■ ■ & STAMPE

FORNITURE ■ ■ ■ ■ ■
 ■ ■ ■ ■ ■ & STAMPE

FORNITURE ■ ■ ■ ■ ■
 ■ ■ ■ ■ ■ & STAMPE

● I numeri in giallo indicano la pagina di riferimento del Listino Prezzi 2024-2025

COMPRESSORE - POMPE Inflator - Pumps



175,50€

Art. 106
Compressore elettrico 220 Volt con borsa
Electric Inflator 220 Volt with bag

pg.19

FORNITURE ■ ■ ■ & STAMPE

FORNITURE ■ ■ ■ & STAMPE

FORNITURE ■ ■ ■ & STAMPE

7,60€

Art. 104-A
Pompa con ago
Pump with needle



FORNITURE ■ ■ ■ & STAMPE

FORNITURE ■ ■ ■ & STAMPE

FORNITURE ■ ■ ■ & STAMPE

18,50€

Art. 2005
Confezione 12 Aghi con valvola per gonfiatura palloni Ø filettatura mm.5
Set 12 Needles with valve for inflating balls Ø 5 mm. thread



pg.19

1,00€

Art. 2005RC
Ago di ricambio per compressore Art. 106 Ø filettatura mm.7,5
Spare needle for electric inflator Art. 106 Ø 7,5 mm. thread



17,90€

Art. PSS
Pompa a staffa
All purpose Pump



FORNITURE ■ ■ ■ & STAMPE

FORNITURE ■ ■ ■ & STAMPE

15,70€

Art. 104-T
Pompetta in gomma soft con ago e valvola di sfiato ideale per gonfiatura palloni in gomma
Soft Pump with needle and valve for inflating rubber balls



● Numbers in yellow show the relevant page on 2024-2025 Price List

● I numeri in giallo indicano la pagina di riferimento del Listino Prezzi 2024-2025

MANOMETRI - CRONOMETRO - ROTELLE METRICHE - CONTAMETRI
Gauges - Chronometer - Measuring Tapes - Meter Counter



9,75€

Art. 107
Manometro misura pressione palloni con valvola (con indicazione pressioni consigliate per vari sport)
 Pressure Gauge with valve (with indication of pressure for different sport balls)



11,10€

Art. CRN.E
Cronometro digitale 1/100 sec.
 Digital Chronometer 1/100 sec.



pg.19

12,90€

Art. US107
Manometro misura pressione palloni alta precisione con valvola (con indicazione pressioni consigliate per vari sport)
 High precision pressure Gauge with valve (with indication of pressure for different sport balls)



82,90€

Art. CMT Contametri fino a m. 9999
 Meter Counter (until m. 9999)



18,50€

Art. PR30
Rotella Metrica in fibra m. 30
 Fiber measuring tape 30 m.

23,20€

Art. PR50
Rotella Metrica in fibra m. 50
 Fiber measuring tape 50 m.

31,00€

Art. PR100
Rotella Metrica in fibra m. 100
 Fiber measuring tape 100 m.

● I numeri in giallo indicano la pagina di riferimento del Listino Prezzi 2024-2025

DA PREVENTIVO

PALLONI CALCIO - Soccer Balls



Special Price



New!



Art. GHYB3 / GHYB4 / GHYB5

Pallone calcio Gems Olimpico Academy da allenamento in PU BIC n. 3, n. 4 e n. 5 vari colori

Ball Gems in PU-BIK size 3, 4 and 5 various colors

Art. GPA4 / GPA5

Pallone calcio Gems Olimpico da allenamento in PU BIC n. 4 e n. 5 vari colori (ad esaurimento)

Ball Gems in PU-BIK size 4 and 5 various colors (until available)

Art. GPA4OT / GPA5OT

Pallone calcio Gems Olimpico Team da allenamento in TPU n. 4 e n. 5 (FIFA Basic) vari colori

Ball Gems in TPU size 4 and 5 various colors

pg.20



Art. 1000MS4 / 1000MS5

Pallone calcio da allenamento Molten misto TPU 1000MS n. 4 e n. 5 (Europa League replica) (ad esaurimento)

Molten training ball TPU size 4 and 5 (Europa League replica) (until available)



New!

Art. F4N1000 / F5N1000

Pallone calcio da allenamento Molten TPU F4N1000/F5N1000 n. 4 e n. 5 Molten training ball TPU size 4 and 5



New!

Art. GRPRO

Pallone calcio Gems Raptor Pro in microfibra da gara n. 5 FIFA Quality Pro

Gems match ball microfibre size 5



Art. F5V48TR

Pallone calcio Molten n. 5 F5V4800 "Trofeo" per allenamento professionisti e gare ufficiali categorie inferiori

Molten Soccer Ball F5V4800 "Trofeo" size 5

● Numbers in yellow show the relevant page on 2024-2025 Price List

● I numeri in giallo indicano la pagina di riferimento del Listino Prezzi 2024-2025

DA PREVENTIVO

PALLONI CALCETTO, DA PALLEGGIO E SPECIALI - Futsal and rubber balls



Art. GBLD
Pallone calcetto Gems
Blade in TPU Soft
a rimbalzo controllato n. 4
 Futsal Ball Gems size 4



Art. GBLEL
Pallone calcetto da gara Gems
Blade Elite in PU Soft Hybrid
a rimbalzo controllato n. 4
 Futsal Match Ball Gems size 4



Art. ULT46-3
Pallone calcetto
in gomma TRIAL triplo
strato rimbalzo controllato
gr.380 - diam. cm.19,9
 Futsal Ball slow rebound
 Trial rubber

● pg.20 ● pg.21



Art. 26854
Pallone feltro indoor n. 4
a rimbalzo normale
 Indoor Ball size 4



Art. 45862
Pallone feltro indoor
n. 4 a rimbalzo controllato
 Indoor slow rebound
 Ball size 4

**Art. ULTST3/ULTST4/
 ULTST5**
Palloni Trial SILVER
STREET n. 3 - 4 - 5
doppio strato
 SILVER STREET Trial balls
 size 3-4-5 double stratum



Art. TRILO
Pallone calcio Trial
TRILO n. 4,5
doppio strato
limita il trauma dovuto
all'impatto con la palla
 Soccer Ball Trial TRILO
 size 4,5 double stratum
 softens ball contact

RETI PORTAPALLONI - Ball sacs



Art. 041-6 / 041-12 / 041-18
Reti Portapalloni in polipropilene
senza nodo (da 6, 12 o 18 palloni)
 Nets for balls in polypropylene
 (for 6, 12 or 18 balls)



Art. S041-6 / S041-12 / S041-18
Reti Portapalloni in polipropilene
con nodo (da 6, 12 o 18 palloni)
 Knotted Nets for balls
 in polypropylene
 (for 6, 12 or 18 balls)

● pg.29

Art. SM20
Sacca Portapalloni
in nylon 420/PVC
capienza 20 palloni
 Ball Sac for 20 balls



● Numbers in yellow show the relevant page on 2024-2025 Price List

● I numeri in giallo indicano la pagina di riferimento del Listino Prezzi 2024-2025

DA PREVENTIVO



FORNITURE ■ ■ ■ ■ ■
■ ■ ■ & STAMPE

FORNITURE ■ ■ ■ ■ ■
■ ■ ■ & STAMPE

Art. 1935S
Pallone calcio in gomma
monostrato n. 3
colore giallo
Rubber soccer Ball
single stratum size 3
color yellow

● pg.20



FORNITURE ■ ■ ■ ■ ■
■ ■ ■ & STAMPE

FORNITURE ■ ■ ■ ■ ■
■ ■ ■ & STAMPE

FORNITURE ■ ■ ■ ■ ■
■ ■ ■ & STAMPE

Special Price

Art. V45 / V44 / V42 / V41 / V40
Palloni calcio in gomma Trial monostrato n. 1 - 2 - 3 - 4 - 5
(misura 5 solo nel colore bianco)
Rubber soccer Balls single stratum Trial size 1 - 2 - 3 - 4 - 5
(size 5 only in white color)

● pg.21

FORNITURE ■ ■ ■ ■ ■
■ ■ ■ & STAMPE

FORNITURE ■ ■ ■ ■ ■
■ ■ ■ & STAMPE



FORNITURE ■ ■ ■ ■ ■
■ ■ ■ & STAMPE

FORNITURE ■ ■ ■ ■ ■
■ ■ ■ & STAMPE

FORNITURE ■ ■ ■ ■ ■
■ ■ ■ & STAMPE

Special Price

Art. ULT42-3 / ULT41-3 / ULT40-3
Palloni calcio in gomma
Trial triplo strato
n. 3 - 4 - 5
Rubber soccer Balls
triple stratum Trial
size 3 - 4 - 5

● Numbers in yellow show the relevant page on 2024-2025 Price List

FORNITURE ■ ■ ■ ■ ■
■ ■ ■ & STAMPE

FORNITURE ■ ■ ■ ■ ■
■ ■ ■ & STAMPE

● I numeri in giallo indicano la pagina di riferimento del Listino Prezzi 2024-2025

DA PREVENTIVO



Art. ULTS40

**Pallone in gomma Trial
allenamento potenziato doppio strato
Ø cm.21,5 - gr.630 (+50%)
Trial heavy rubber ball double stratum**



Art. ULTD40

**Pallone in gomma Trial
allenamento potenziato doppio strato
Ø cm.21,5 - gr.840 (+100%)
Trial heavy rubber ball double stratum**

pg.21



Art. TRBC

**Pallone Reaction Ball Trial
doppio strato rimbalzo e traiettorie
imprevedibili per calcio
Trial Reaction Ball double stratum
unpredictable rebounds for soccer**



Art. B703316

**Reflex ball
pallone prismatico
in pelle sintetica
Prismatic ball in
synthetic leather**



Art. E44

**Pallone sonoro
Torball per calcio CIP
in gomma Trial
Ø cm.20,5 - gr.500
Trial rubber Torball**



pg.20

Art. 149S14

**Pallone in gommapiuma
Ø cm. 14
Foam rubber ball Ø 14 cm.**



Art. 149S

**Pallone in gommapiuma
Ø cm. 20
Foam rubber ball Ø 20 cm.**



pg.21

Art. E48

**Pallone sonoro Trial
per non vedenti
Ø cm.22 - gr.470
Trial rattle ball for blind people**

DA PREVENTIVO

● I numeri in giallo indicano la pagina di riferimento del Listino Prezzi 2024-2025

PALLE MEDICHE - Medicine Balls



pg.21

Art. AHF-105 / AHF-106 / AHF-107 / AHF-108 / AHF-109 / AHF-110

**Palle Mediche
rigonfiabili e rimbalzanti
kg. 1 - 2 - 3 - 4 - 5 - 6
ad alto grip colore nero
Medicine Balls
inflatable and rebounding
high grip in black color**



Art. 048 / 050 / 051 / 052 / 053

**Palle Mediche rigonfiabili
e rimbalzanti Trial
kg. 1 - 2 - 3 - 4 - 5
(il colore varia
a seconda del peso)
Trial Medicine Balls
inflatable and rebounding
different colors for different weights**



Art. DGMB3 / ... / DGMB10

**Palle Mediche
con maniglie
kg. 3 - 4 - 6 - 8 - 10
(kg. 2 ad esaurimento)
Medicine Balls
with handles**

pg.22

Art. AHF-048/.../AHF-097

**SLAM BALL
kg. 2 - 3 - 4 - 5 - 6 - 7 - 8 9 -
10 - 12 - 15**



Art. AHF-224/.../AHF-232

**WALL BALL
kg. 3 - 4 - 5 - 6 - 7 - 8
9 - 10 - 12**



pg.13

Art. KEB4 / KEB6 / KEB8 / KEB10 / KEB12 / KEB16 / KEB20 / KEB24

**Kettlebell in ghisa verniciata con base in gomma
kg. 4 - 6 - 8 - 10 - 12 - 16 - 20 - 24
Painted cast iron Kettlebells - rubber base**

**Art. RVKEB
Rastrelliera verticale
porta kettlebell/
palle mediche
(8 posti)
8-seater vertical rack
for cast iron
Kettlebells/
Medicine Balls**

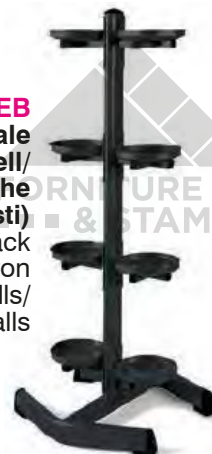

pg.22

Art. OV500 / OV1 / OV2 / OV3 / OV4 / OV5
**Over Ball Trial kg.0,5 - 1 - 2 - 3 - 4 - 5
con impugnatura anatomica
Over Ball Trial**



Special Price

**Art. WMD100 / WMD200
WMD300 / WMD400 / WMD500
Palle Mediche morbide Bubble
Trial - kg. 1 - 2 - 3 - 4 - 5
Soft Trial Medicine Bubble Balls
kg. 1 - 2 - 3 - 4 - 5**

pg.22



● I numeri in giallo indicano la pagina di riferimento del Listino Prezzi 2024-2025

DA PREVENTIVO

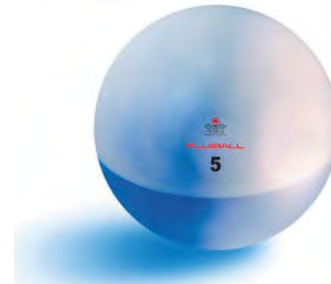
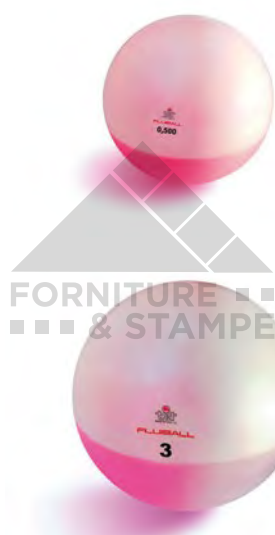

Art. FLUIB05 / FLUIB1 / FLUIB2 / FLUIB3 / FLUIB4 / FLUIB5

Palle mediche FLUIBALL riempite con acqua demineralizzata colorata - peso kg. 0,5-1-2-3-4-5

FLUIBALL Medicine balls filled with demineralized coloured water - weight 0,5-1-2-3-4-5 Kg.

Grazie a queste nuove palle mediche gli atleti utilizzano carichi non inerti ma dinamici, effettuando esercizi di forza coordinata nuovi e destabilizzanti. La massa oscillante all'interno della palla medica FLUIBALL impone, sia in fase di lancio che di carico, adattamenti muscolari e coordinativi istantanei la cui intensità è variabile, e quindi non prevedibile. Inoltre, per i più giovani le palle mediche FLUIBALL sono molto efficaci per la memorizzazione della tecnica e per migliorare la conoscenza ed il controllo del proprio corpo. È possibile gonfiare e sgonfiare tutte le FLUIBALL variandone così la sofficietà

The new FLUIBALL medicine balls allow new exercises for muscle strength, equilibrium and coordination.

The liquid inside these balls makes them dynamic weights that require new rapid and adapting movements both when throwing and when lifting. Younger players will also improve and memorize body movements enhancing their equilibrium. These balls can be inflated or deflated so that softness will change

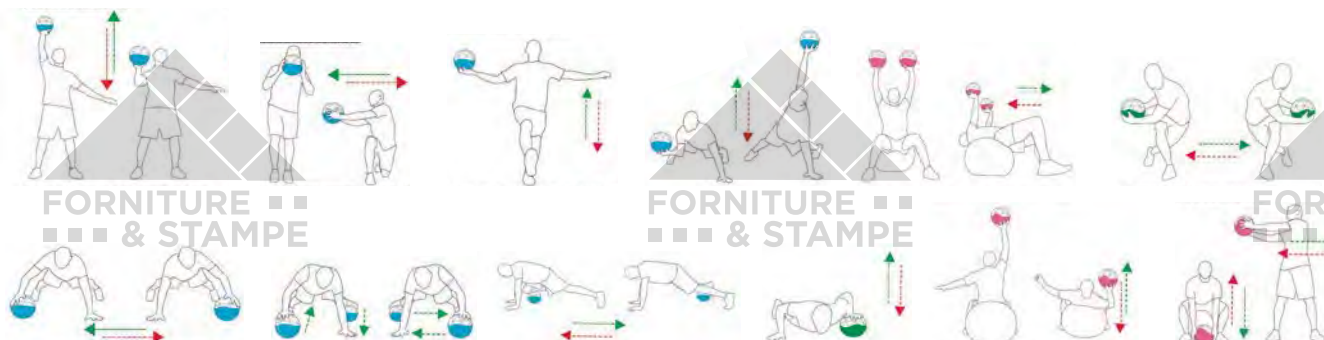

Con le palle mediche FLUIBALL è possibile effettuare un allenamento dinamico utile per il rafforzamento degli arti inferiori e superiori, e per migliorare l'abilità nel lancio e nella presa

With FLUIBALL you can run a dynamic training good for strengthening the lower and upper limbs, and to increase the ability of making throws and holds

Art. POL1 / POL1.5 / POL2 / POL3 / POL3.5

POLIBOLO - Over Ball Trial a massa oscillante (riempite con acqua distillata) peso kg.1 - 1,5 - 2 - 3 - 3,5

POLIBOLO - Over Ball Trial filled with distilled water - weights 1 - 1,5 - 2 - 3 - 3,5 Kg.



Le Over Ball e le Polibolo possono essere utilizzate sia come manubri sia come palle mediche

Over Balls and Polibolos can be used both as dumbbells and medicine balls

● Numbers in yellow show the relevant page on 2024-2025 Price List

● I numeri in giallo indicano la pagina di riferimento del Listino Prezzi 2024-2025

DA PREVENTIVO

PALLE RITMICHE, PSICOMOTORIE E LUDICHE - Rhythmic and Gym Balls



pg.21

Art. GS42/GS41/GS40/GS39 Palle Ritmiche Trial - Trial Rhythmic Balls gr. 400-350-250-150



Ideali per trattamento
fisioterapico,
equilibrio, stretching,
tonificazione, attività
aerobica, scarico
vertebrale,
riscaldamento,
potenziamento
muscolare ...

Very useful for injury
recovery, equilibrium,
stretching, muscle
training, aerobic activity,
warm up ...



Art. 30934/30935/30936/31036

Palle psicomotorie monostrato

Gym balls single stratum

Ø cm. 55

Ø cm. 65

Ø cm. 75

Ø cm. 85

**Art. V10/V11/V12/V13/V14/V15/
V16/V17/V18/V19**

**Palle psicomotorie Trial in
gomma doppio strato**

(il colore varia
a seconda del diametro)

Trial Gym balls
in double stratum rubber

Ø cm.14-18-22-30

42-53-65-90-120-150



pg.23

Art. V-LAB

**Palla psicomotoria Trial La Ball
con range di possibile utilizzo
da cm.50 a cm.70
struttura instabile in gomma doppio
strato particolarmente elastica**

Gym ball Trial La Ball
inflatable from 50 to 70 cm.

changing shape

concept in very elastic

double stratum rubber



● Numbers in yellow show the relevant page on 2024-2025 Price List

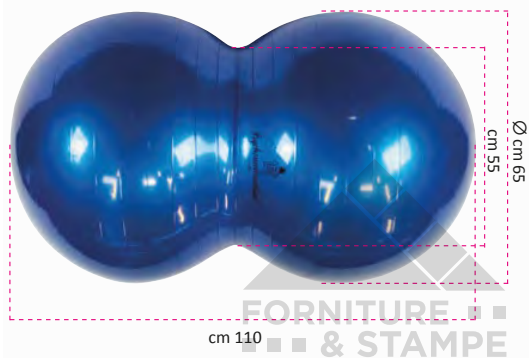

Art. TERV16
X-Ball Trial ø cm.65
X-Ball Trial ø 65 cm.

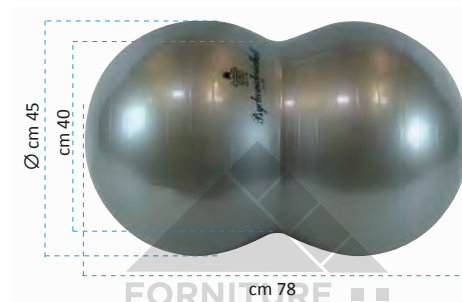

Art. TERV14
X-Ball Trial ø cm.45
X-Ball Trial ø 45 cm.



Art. TERV12
Small Peanut Trial ø cm.35
Small Peanut Trial ø 35 cm.

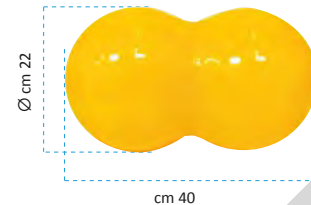

Art. TERV10
Small Peanut XS
Trial ø cm.22
Small Peanut XS
Trial ø 22 cm.

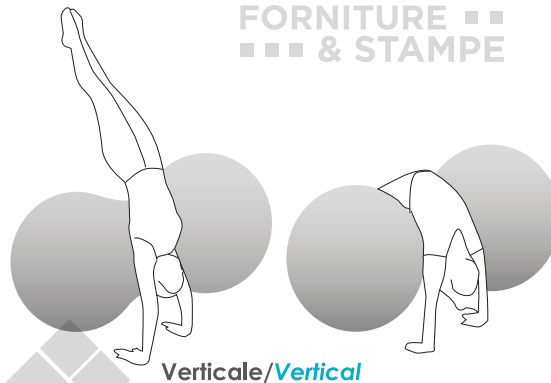

Verticale/Vertical

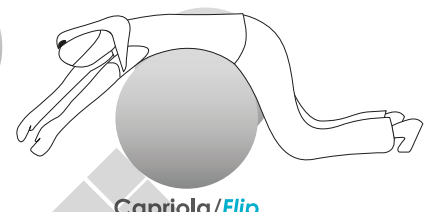

Capriola/Flip

Attrezzi polivalenti in gomma sintetica in doppio strato reticolato che consentono nuovi esercizi ideati per il consolidamento degli schemi motori, alla rieducazione e riabilitazione, alla ginnastica dolce. Nella riabilitazione sono uno strumento che dà sicurezza offrendo migliore stabilità agli esercizi. X-Ball in particolare, con il restringimento centrale che la rende in parte concava, può essere utilizzata anche per insegnare la capriola e la verticale in totale sicurezza.

Infatti, in ambito educativo, consente di effettuare esercizi a due bambini (lavoro di gruppo e socializzazione) o ad uno solo (cavalcioni) in assoluta sicurezza fisica e psicologica. Indispensabile anche nel trattamento fisioterapico per riscaldamento, stretching, tonificazione. Rigonfiabile e resistente a carichi anche elevati.

Small Peanut e Small Peanut XS sono dedicate ai più piccoli in virtù dell'altezza minima dal terreno.

Abbandonarsi sulla palla, aiutando il movimento con il rotolamento e l'allungamento, permette ai bambini di sperimentare nuove sensazioni che portano ad una maggiore consapevolezza del corpo e delle sue capacità. Il diametro è studiato per accompagnare i movimenti, e accogliere il corpo perfettamente rilassato soprattutto nell'appoggio di braccia e gambe.

La qualità, la morbidezza e l'elasticità le rendono assolutamente sicure

Multi-purpose tools in double layer synthetic rubber that allow new exercises suitable for consolidation of motor patterns, to re-education and rehabilitation, to gymnastics. In rehabilitation they give security by offering better exercise stability. X-Ball in particular, with the central narrowing that makes it partly concave, can also be used for teaching the somersault and the handstand in total safety.

In fact, in the educational field, it allows exercises for two children (group work and socialization) or to one (astride) in absolute physical and psychological safety. Really useful also in physiotherapy treatment for warming up, stretching, toning. Re-inflatable and resistant to even high loads.

Small Peanut and Small Peanut XS are dedicated to children due to the minimum height from the ground.

Indulging on the ball, helping the movement with rolling and stretching, allows them to experience new sensations that lead to a greater awareness of their body and its capabilities. The diameter is designed to accompany their movements, and accommodate the relaxed body especially in resting the arms and legs.

Quality, softness and elasticity make them absolutely safe

● I numeri in giallo indicano la pagina di riferimento del Listino Prezzi 2024-2025

DA PREVENTIVO

Art. ULTbbs3
Pallone Jumbo Trial a 3 strati
 Ø cm.28 - gr.280
 Jumbo Trial Ball triple stratum
 Ø 28 cm. - 280 gr.



Rimbalzo normale con diametro maggiorato per favorire l'apprendimento del bambino
 Normal rebound with bigger diameter for youngest training and fun

pg.21



Le palle sensoriali rimbalzanti esaltano la tattilità e rappresentano anche uno strumento di automassaggio a pressione
 To stimulate touch and also useful massage tools



Art. BTR1
Palla sensoriale Ø cm. 21 - gr. 420
 Sensory Ball Ø 21 cm. - 420 gr.

Art. BTR2
Palla sensoriale Ø cm.12 - gr. 180
 Sensory Ball Ø 12 cm. - 180 gr.

Allenando la visibilità laterale migliorano la percezione dello spazio, i movimenti e la sicurezza nella vita quotidiana
 For space perception, coordination and everyday life safety

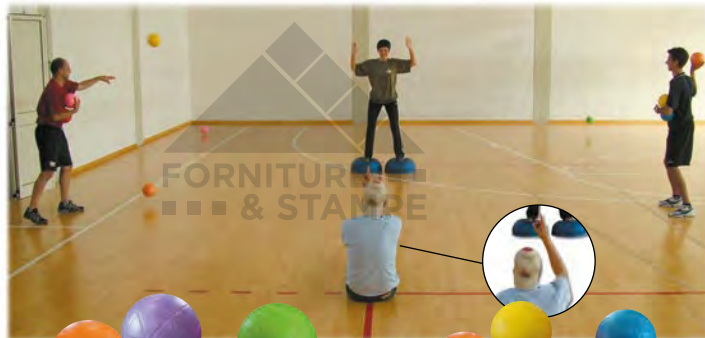

Art. TLV16
Palle morbide Trial per allenamento della visibilità laterale - set di 6 palle
 Ø cm. 16 gr. 110
 Soft balls for lateral visibility training - set of 6 balls
 Ø 16 cm. 110 gr.

Art. TLV21
Set di 6 palle
 Ø cm. 21 gr. 160
 Soft balls for lateral visibility training - set of 6 balls
 Ø 21 cm. 160 gr.

pg.8



pg.21

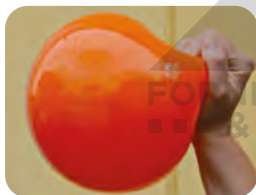

Art. BS1T
PALLONE BASIC jelly touch
 Ø 12/16 cm. gr.140 - colore verde
 Basic Ball green color

Art. BS2T
PALLONE BASIC jelly touch
 Ø 16/22 cm. gr.180 - colore arancio
 Basic Ball orange color

Art. BS3T
PALLONE BASIC jelly touch
 Ø 22/28 cm. gr.240 - colore rosso
 Basic Ball red color

● I numeri in giallo indicano la pagina di riferimento del Listino Prezzi 2024-2025

CONTENITORI PORTAPALLONI - Baskets for balls



100,00€

Art. FP400
Contenitore portapalloni a soffietto in alluminio
 cm. 60x60x100h pieghevole con sacca
 Basket for balls in aluminium
 60x60x100h cm. foldable with bag



172,00€

Art. F401

Contenitore portapalloni in ferro verniciato
 cm. 80x55x60h pieghevole
 Basket for balls in painted steel 80x55x60h cm. foldable



276,00€

Art. F404

Contenitore portapalloni
in rete metallica verniciata
 cm. 70x70x70h pieghevole
 con lucchetto
 Basket for balls
 painted with metallic net
 70x70x70h cm.
 foldable, with lock

pg.23



189,90€

Art. F402

Contenitore portapalloni
in ferro zincato
 cm. 60x60x90h pieghevole
 Basket for balls
 in galvanized steel
 60x60x90h cm. foldable

433,00€

Art. F403G **Contenitore portapalloni**
in ferro verniciato cm. 100x75x90h
pieghevole con lucchetto
 Basket for balls in painted steel
 100x75x90h cm. foldable, with lock



pg.23

472,00€

Art. F403ZN

Contenitore portapalloni
in ferro zincato cm. 100x75x90h
pieghevole con lucchetto
 Basket for balls in galvanized steel
 100x75x90h cm. foldable, with lock



● I numeri in giallo indicano la pagina di riferimento del Listino Prezzi 2024-2025

BORSE - Bags

42,70€

Art. STD02

Borsa Big doppio fondo
cm. 53,5x45h.x32,5
poliestere 600
Soccer bag large

39,75€

Art. STD09

Borsa Medium doppio fondo
cm. 50x42h.x30
poliestere 600
Soccer bag medium

28,15€

Art. STD03

Borsa Small doppio fondo
cm. 47,5x40h.x26,5
poliestere 600
Soccer bag small



QUANTITÀ PER MODELLO E COLORE MULTIPLA DI 10 PEZZI
Quantity by model and color multiple of 10 pieces

COLORI DISPONIBILI
rosso, royal, navy (no Small), nero, verde, bordeaux
Colors: red, royal, black, green, navy (no Small), bordeaux



FORNITURE & STAMPE

pg.23

FORNITURE & STAMPE

QUANTITÀ PER COLORE MULTIPLA DI 15 PEZZI
Quantity by color multiple of 15 pieces



QUANTITÀ PER COLORE MULTIPLA DI 10 PEZZI

Quantity by color multiple of 10 pieces

Art. STD04

Borsa TOP bicolore in poliestere 600 con fondo rigido h. 15 cm. con tracolla e porta nome, tre tasche, dim. cm. 53,5x45h.x32,5
colori: navy/royal, nero/grigio, navy/rosso, nero/verde, navy/giallo, nero/rosso, nero/bordeaux
Soccer Bag bicolor in polyester 600 1 pocket size 53,5x45h.x32,5 cm.
colors: navy/royal, black/grey, navy/red, black/green, navy/yellow, black/red, black/bordeaux

49,50€



Art. STD18

Zainetto doppio fondo poliestere 600 2 tasche - cm. 34x47h.x24 fondo rigido
colori: royal, nero, rosso, navy, verde, bordeaux
Rucksack in 6 different colors

30,15€

● Numbers in yellow show the relevant page on 2024-2025 Price List

26,90€

Art. STD20
Borsa Portamute cm. 65x34h.x27
poliestere 600 - colore nero
Soccer bag for uniforms
dim. 65x34h.x27 cm. - color black



**QUANTITÀ PER COLORE
MULTIPLA DI 10 PEZZI**
Quantity by color
multiple of 10 pieces



37,70€

Art. STD08
Borsa palestra poliestere 600 cm.60x30h.x32
con due tasche e vano portascarpe
colori rosso, royal, navy, nero
Gym Bag color black, red, royal, navy

pg.24



4,10€

Art. ZBGL
BORSA/ZAINETTO monocolor economica
cm. 36x38 vari colori - serigrafabile su richiesta
Backpack one color with your logo on request



36,90€

Art. STD07
Borsa Medica dim. cm. 40x28,5h.x20
poliestere 600 - colore nero
Bag for First Aid 40x28,5h.x20 cm.



23,20€

Art. BMD
Borsa Medica dim. cm. 37x29h.x17
Bag for First Aid 37x29h.x17 cm.

PORTE CALCIO - Soccer Goals



Art. SPP45
Set 4 protezioni imbottite h. cm. 200 per paletti posteriori tendirete
Set of 4 soft protections 200 cm. height for net holder posts

Da abbinare preferibilmente a reti con profondità cm. 170x170 oppure cm.200x200
To be combined preferably with nets with depth 170x170 cm. or 200x200 cm.

Art. SPR45
Set protezioni imbottite per coppia ribaltine alzarete
Set of soft protections for pair of ground backframes

Art. GPRVE
Kit guaina di rivestimento in PVC verde per protezioni Art. SPR45
Kit external coating in green PVC for soft protections Art. SPR45

Art. 109

Coppia Porte fisse regolamentari in lega leggera costruite secondo lo standard europeo di qualità UNI EN 748 con paletti tendirete posteriori in acciaio zincato, pali sezione mm. 120x100 verniciati con smalto acrilico non tossico, ganci reggirete e bussole per interrimento pali incluse (ribaltine alzarete non incluse)
Pair of regular Goals in light alloy manufactured according to the UNI EN 748 European standard of quality norms. Pipe section 120x100 mm. painted with non toxic white. Net holders, rear posts and underground sockets included (liftable ground backframes not included)

pg.24

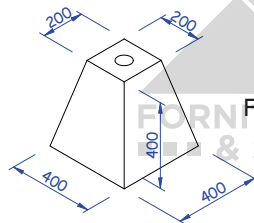
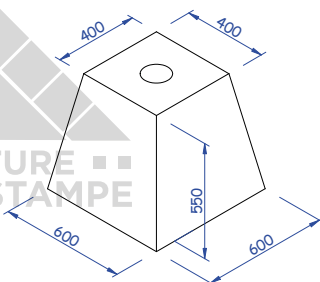

Ancoraggio tramite plinti in cemento (non inclusi)
Fixing with concrete blocks (not included)

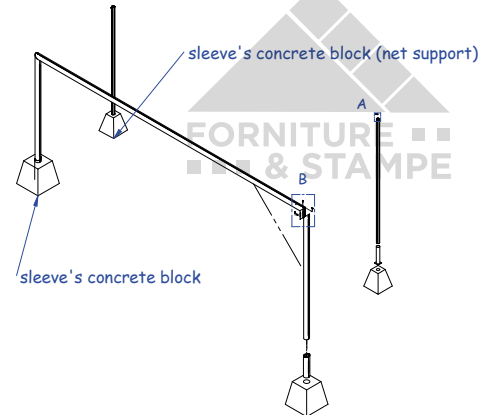

ATTENZIONE: in caso di ordine errato da parte del Cliente le porte, una volta consegnate, non possono essere rese

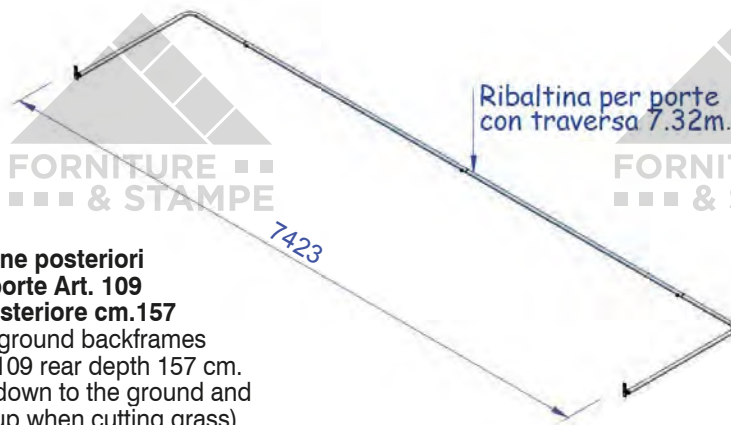

Art. 109.G
Coppia ribaltine posteriori alzarete per porte Art. 109 profondità posteriore cm.157
Pair of liftable ground backframes for Goals Art. 109 rear depth 157 cm. (to keep nets down to the ground and to raise them up when cutting grass)

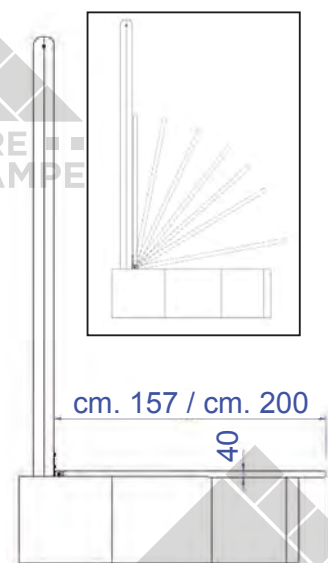

Art. 109.G200
Coppia ribaltine posteriori alzarete per porte Art. 109 profondità posteriore cm.200
Pair of liftable ground backframes for Goals Art. 109 rear depth 200 cm. (to keep nets down to the ground and to raise them up when cutting grass)

I numeri in giallo indicano la pagina di riferimento del Listino Prezzi 2024-2025



Da abbinare preferibilmente a reti con profondità cm. 100x200
To be combined preferably with nets with depth 100x200 cm.



Art. 120-RG pg.25
Coppia ruote per porte trasportabili regolamentari Art. 110FG, 110-D e 110G
Pair of wheels for regular size transportable goals Art. 110FG, 110-D and 110G

Art. 110FG Coppia Porte Trasportabili in lega leggera dimensioni regolamentari profilo sezione mm. 120x100 verniciate con smalto acrilico non tossico base di appoggio posteriore con tubo tondo in ferro - a norma UNI EN 748
Pair of transportable Goals in light alloy regular size, pipe section mm. 120x100 painted with non toxic white - back frame in round iron pipe - UNI EN 748 standard

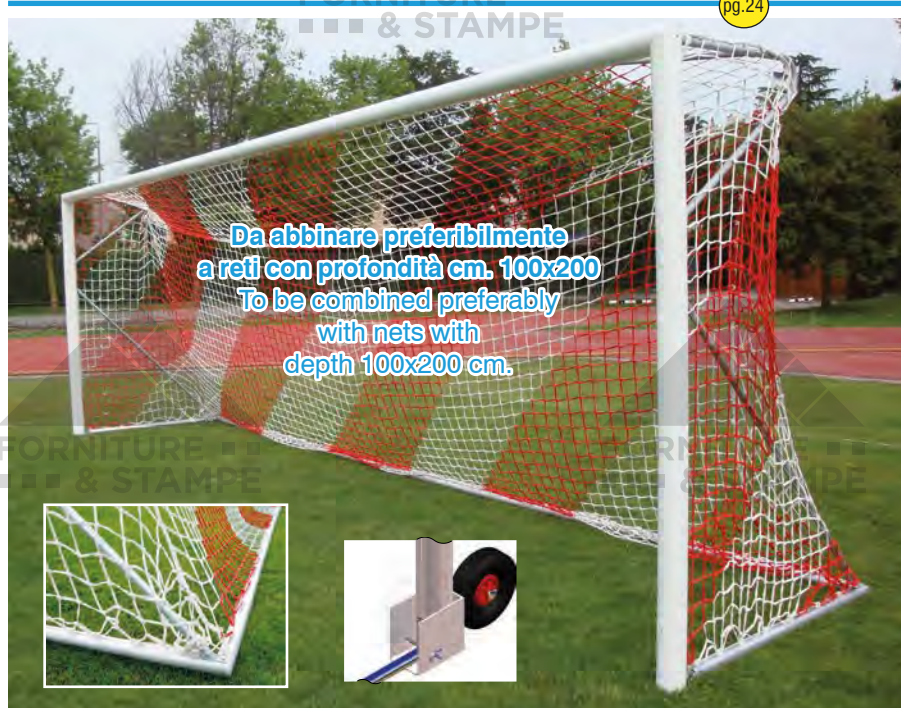

Da abbinare preferibilmente a reti con profondità cm. 100x200
To be combined preferably with nets with depth 100x200 cm.

pg.24

LE PORTE TRASPORTABILI IN FASE DI GIOCO DEVONO ESSERE ZAVORRATE SULLA BASE POSTERIORE O FISSATE A TERRA CON PICCHETTI PER MOTIVI DI SICUREZZA. LE RUOTE GOMMATE SONO OPTIONAL

Transportable goals must always be anchored to the ground by sacs of sand or metal pegs, for safety reasons. Wheels are optional

Art. 110-D
Coppia Porte Trasportabili dim. regolamentari in lega leggera profilo sezione mm. 120x100 - verniciate con smalto acrilico non tossico base di appoggio posteriore con profilo ovale in alluminio mm. 65x55 - a norma UNI EN 748
Pair of transportable Goals in light alloy regular size, pipe mm. 120x100 painted with non toxic white - back frame in aluminium ovoidal pipe 65x55 mm.



Art. AMCP pg.26
Carrello per il trasporto di porte (trasportabili) regolamentari e ridotte - brevettato
Patented trolley for moving official and junior size transportable goals

I numeri in giallo indicano la pagina di riferimento del Listino Prezzi 2024-2025



Art. 110G Coppia Porte Trasportabili in lega leggera dimensioni regolamentari profilo mm. 120x100 verniciate con smalto acrilico non tossico, base di appoggio posteriore con profilo in lega mm. 120x100 - a norma UNI EN 748 e FIGC
 Pair of transportable Goals in light alloy regular size, pipe mm. 120x100, painted with non toxic white - back frame pipe 120x100 mm. - UNI EN 748 and FIGC standard



Art. 110GMR Set 4 ruote per porte trasportabili regolamentari Art. 110G (2 set per 1 coppia di porte). Ciascuna ruota in dotazione ha una posizione di riposo e una posizione di trasporto (per passare dall'una all'altra occorre far ruotare il dispositivo intorno al perno). Dunque, le ruote restano sempre fissate al telaio posteriore della porta

Set of 4 wheels for regular size transportable goals Art. 110G (2 set for 1 pair of goals). Each wheel remains fixed to the back ground frame also when goals are in use, in stand by position. To switch the wheel into transport position you have to turn it around the pivot

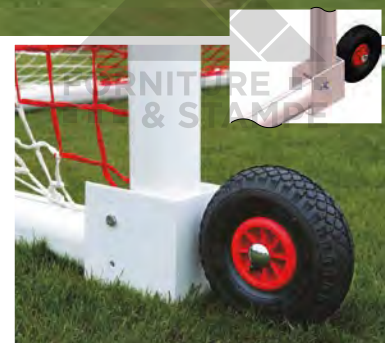

Art. 120-RG Coppia ruote per porte trasportabili regolamentari Art. 110FG, 110-D e 110G
 Pair of wheels for regular size transportable goals Art. 110FG, 110-D and 110G

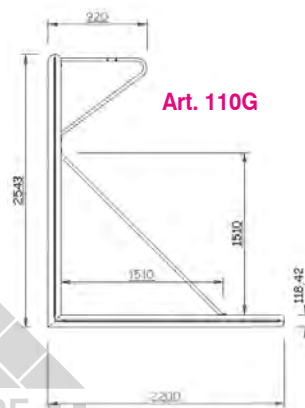

Art. 110G

Art. 4580M Mollone per ancoraggio porte trasportabili regolamentari e ridotte su terreno naturale
 Spring for goal anchoring on natural grass



Art. AFC Zavorra in alluminio per ancoraggio porte trasportabili regolamentari e ridotte
 Aluminium weighted pipes for goal anchoring

ATTENZIONE: in caso di ordine errato da parte del Cliente le porte, una volta consegnate, non possono essere rese

Art. DSSCE Sacco zavorra vuoto (da riempire con sabbia) per ancoraggio porte trasportabili regolamentari e ridotte
 Empty Ballast Bag (to be filled with sand) for goal anchoring



Art. DSS20 Sacco zavorra kg. 20 (riempito con sabbia) per ancoraggio porte trasportabili regolamentari e ridotte
 Ballast Bag weight 20 Kg. for goal anchoring

Porte fisse (con bussole e pali da interrare) e trasportabili in lega leggera o acciaio, sezione tubo mm. 120x100 o mm.80 - dimensioni m. 3x2 - m. 4x2 - m. 5x2 - m. 6x2
 Fixed and transportable Goals in light alloy or painted steel, pipe section 120x100 mm. or 80 mm. dimensions m. 3 x 2 - m. 4 x 2 - m. 5 x 2 - m. 6 x 2

pg.25

pg.26

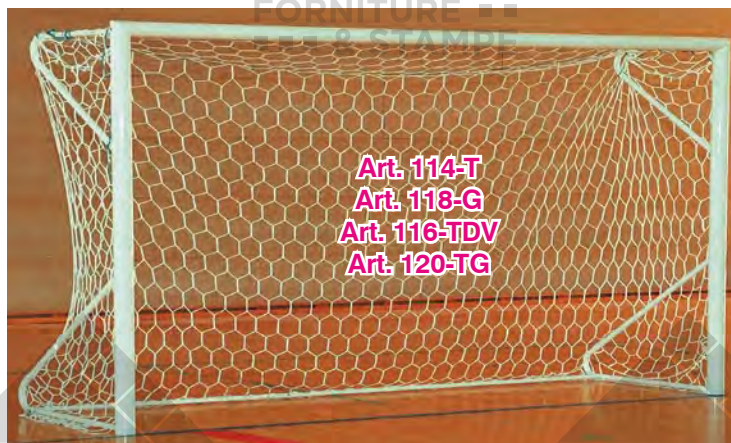

Art. 114-T
 Art. 118-G
 Art. 116-TDV
 Art. 120-TG

Base posteriore in tubo tondo
 Round pipe ground base

ATTENZIONE: in caso di ordine errato da parte del Cliente le porte, una volta consegnate, non possono essere rese

Art. 114-T

Coppia Porte m. 4 x 2 a traversa intera in acciaio trasportabili tubo sezione 80 mm.
 Pair of Goals m. 4 x 2 - 1 piece crossbar in painted steel, transportable, pipe 80 mm.

Art. 118-G

Coppia Porte m. 4 x 2 a traversa intera in lega di alluminio trasportabili tubo sezione 80 mm.
 Pair of Goals m. 4 x 2 - 1 piece crossbar in light alloy, transportable, pipe 80 mm.

Art. 116-TDV

Coppia Porte m. 5 x 2 a traversa divisa in lega di alluminio trasportabili tubo 80 mm.
 Pair of Goals m. 5 x 2 - crossbar in 2 pieces in light alloy, transportable, pipe 80 mm.

Art. 120-TG

Coppia Porte m. 6 x 2 a traversa divisa in lega di alluminio trasportabili tubo sezione 80 mm.
 Pair of Goals m. 6 x 2 - crossbars in 2 pieces in light alloy, transportable, pipe 80 mm.

Art. 118A
Coppia Porte m. 4 x 2 a traversa divisa in lega di alluminio trasportabili tubo 80 mm. con base posteriore a sezione quadra
 Pair of Goals m. 4 x 2 - crossbars in 2 pieces in light alloy, transportable, pipe 80 mm. with square pipe ground bases

Art. 1129A
Coppia Porte m. 5 x 2 a traversa divisa in lega di alluminio trasportabili tubo 80 mm. con base posteriore a sezione quadra
 Pair of Goals m. 5 x 2 - crossbars in 2 pieces in light alloy, transportable, pipe 80 mm. with square pipe ground bases

Art. 1121A
Coppia Porte m. 6 x 2 a traversa divisa in lega di alluminio trasportabili tubo 80 mm. con base posteriore a sezione quadra
 Pair of Goals m. 6 x 2 - crossbars in 2 pieces in light alloy, transportable, pipe 80 mm. with square pipe ground bases



Base posteriore a sezione quadra
 Reinforced ground base

Art. 118A
 Art. 1129A
 Art. 1121A

Da abbinare esclusivamente a reti con profondità cm. 100x160
 To be combined only with nets with depth 100x160 cm.

LE PORTE TRASPORTABILI IN FASE DI GIOCO DEVONO ESSERE ZAVORRATE SULLA BASE POSTERIORE O FISSATE A TERRA CON PICCHETTI PER MOTIVI DI SICUREZZA. LE RUOTE GOMMATE SONO OPTIONAL
 Transportable goals must always be anchored to the ground by sacs of sand or metal pegs, for safety reasons. Wheels are optional



Art. 120-R
Coppia ruote per porte trasportabili ridotte Art. 118A, 1129A, 1121A
 Pair of wheels for reduced size transportable goals Art. 118A, 1129A, 1121A

pg.26



Art. 4640
Coppia ruote per porte trasportabili ridotte Art. 114-T, 118-G, 116-TDV, 120-TG
 Pair of wheels for reduced size transportable goals Art. 114-T, 118-G, 116-TDV, 120-TG



Le porte ridotte sono disponibili anche nel modello fisso con bussole e pali da interrare
 Available also fixed models with underground sockets



Art. 119G
Art. 120-G

Da abbinare esclusivamente a reti con
profondità cm. 100x160
To be combined only with nets with
depth 100x160 cm.

1705,00€

1785,00€

Art. 119G Coppia Porte m. 5 x 2 a traversa divisa
in acciaio trasportabili tubo 80 mm.
Pair of Goals m. 5 x 2 crossbar in 2 pieces in painted steel,
transportable, pipe 80 mm.

Art. 120-G Coppia Porte m. 6 x 2 a traversa divisa
in acciaio trasportabili tubo sezione 80 mm.
Pair of Goals m. 6 x 2 crossbars in 2 pieces
in painted steel, transportable, pipe 80 mm.

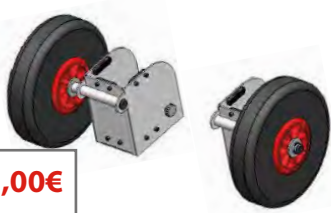

205,00€

Art. 240RU Coppia ruote
gommate con staffa per porte
Art. 119G/120-G
Pair of wheels for transportable
goals Art. 119G/120-G



47,80€

Art. 240AF Kit di fissaggio a
terra per porte Art. 119G/120-G
Ground anchoring kit for
transportable goals
Art. 119G/120-G

pg.25

26,30€

Art. 241C Chiave per kit
di fissaggio Art. 240AF
Key for ground anchoring
kit Art. 240AF



ATTENZIONE:
in caso di ordine errato da parte del Cliente
le porte, una volta consegnate,
non possono essere rese



Art. 122G
Art. 121G

1140,00€

Art. 122G
Coppia Porte Calcetto m. 3 x 2 trasportabili
in acciaio verniciato tubo sezione 80 mm.
Pair of Goals m.3x2 transportable in painted steel pipe 80 mm.

Art. 121G
Coppia Porte Calcetto m. 3 x 2 trasportabili
in lega leggera tubo sezione 80 mm.
Pair of Goals m.3x2 transportable in light alloy pipe 80 mm.

1519,00€

pg.26

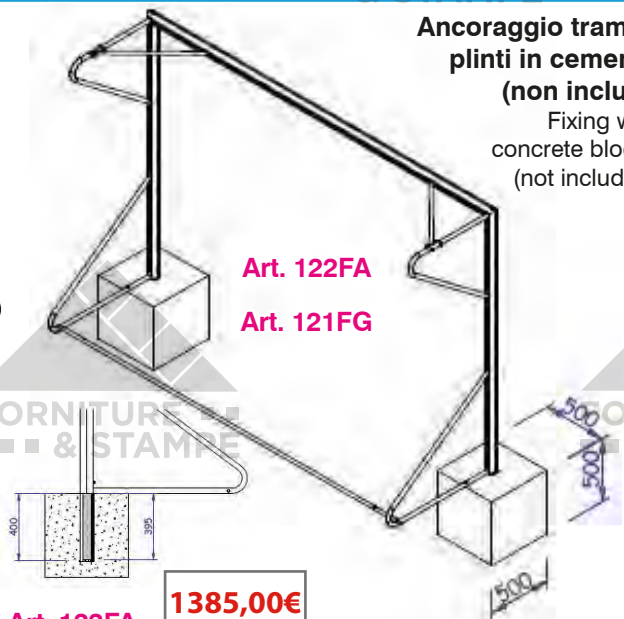

**Ancoraggio tramite
plinti in cemento
(non inclusi)**
Fixing with
concrete blocks
(not included)

Art. 122FA
Art. 121FG

1385,00€

Art. 122FA
Coppia Porte Calcetto m. 3 x 2 fisse con bussole da
interrare in acciaio verniciato tubo 80 mm.
Pair of Goals m.3x2 fixed in painted steel pipe 80 mm.

Art. 121FG
Coppia Porte Calcetto m. 3 x 2 fisse con bussole da
interrare in lega leggera tubo 80 mm.
Pair of Goals m.3x2 fixed in light alloy pipe 80 mm.

1715,00€

I numeri in giallo indicano la pagina di riferimento del listino Prezzi 2024-2025

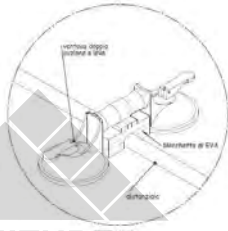

Art. VTCL **56,50€**
Ventosa doppia per ancoraggio a terra
porte calcetto su superfici indoor lisce
(si consigliano 2 kit per ciascuna porta)
 Ground anchoring suckers for reduced goals
 to be used upon indoor smooth floors
 (it takes 2 kits for every goal)

pg.26



Art. PC04
Picchetto in acciaio
per ancoraggio
di porte ridotte **12,50€**
con distanziale sottile
su terreno naturale
 Steel anchoring hook
 for reduced soccer goals
 with thin pipe ground bases

Art. DSSCE **50,00€**
Sacco zavorra vuoto
(da riempire con sabbia)
per ancoraggio
porte trasportabili
regolamentari e ridotte
 Empty Ballast Bag
 (to be filled with sand)
 for goal anchoring



Art. DSS20 **62,00€**
Sacco zavorra kg. 20
(riempito con sabbia)
per ancoraggio
porte trasportabili
regolamentari e ridotte
 Ballast Bag weight 20 Kg.
 for goal anchoring

Art. AM01.7/.../AM01.3

TUBO ZAVORRA in PVC diametro 50 mm. atossico,
flessibile, modellabile, appesantito da composto
ecologico (peso 6 Kg. per metro) resistente alle alte e
basse temperature e ai raggi ultravioletti
per porte ridotte mt. 3x2/4x2/5x2/6x2
e regolamentari sia fisse che trasportabili

Weighted soft pipe 50 mm. diameter
 (6 Kg. per meter) resistant to high/low
 temperatures and ultra violet rays
 for safe anchoring of transportable goals
 m. 3x2/4x2/5x2/6x2 and official size goals
 to the ground

386,00€

366,00€

355,00€

337,00€

320,00€

7,32

6x2

5x2

4x2

3x2



Art. 353.G10

Serie 100 ganci reggirete di ricambio modello a rotazione
per porte regolamentari o ridotte
 100 spare Net Holders rotating model
 for regular and reduced goals

79,90€

79,90€



Art. 353.G13



Art. AS8060

Serie 100 ganci reggirete di ricambio
da fissare con viti
 100 spare Net Holders

109,00€



109,90€

Art. 353 Serie 100 ganci reggirete
di ricambio modello con vite per porte
regolamentari o ridotte
 100 spare Net Holders with screws
 for regular and reduced goals

pg.26



104,50€

Art. V590010
Serie 100 ganci
reggirete
di ricambio
 100 spare
 Net Holders



104,50€

Art. V680011 Serie 100 ganci
reggirete di ricambio
a base rotonda da fissare con viti
 100 spare Net Holders

ATTENZIONE: verificate la tipologia dei ganci
delle Vostre porte prima di ordinare i ricambi
 Please check the model of your holders
 before ordering spares



Art. GFG
Gancio
reggirete
di ricambio
in ferro con
piastrina
 Spare iron
 Net Holder

3,75€



42,70€

Art. SC1051
Serie 100 ganci
reggirete
di ricambio
 100 spare
 Net Holders



Art. 110BAG
Serie 60 ganci
reggirete
di ricambio
 60 spare
 Net Holders

53,60€

Numbers in yell

vant page on 2024-2025 Price List

- 143 -



pg.26

Ideale per uso privato
Not for official matches

168,00€

Art. SG176

Porta m. 3x2 trasportabile in ferro verniciato, tubo sezione mm. 32 completa di rete, ganci e picchetti

3x2 meter transportable Goal in painted iron, pipe section 32 mm. complete with net and anchor pegs



pg.26

Ideale per uso privato
Not for official matches

224,00€

Art. 500SG

Porta m. 3x2 trasportabile in ferro verniciato, tubo sezione mm. 50 completa di rete, ganci e picchetti

3x2 meter transportable Goal in painted iron, pipe section 50 mm. complete with net and anchor pegs

ATTENZIONE: in caso di ordine errato da parte del Cliente le porte, una volta consegnate, non possono essere rese

PORTE BIFRONTALI in lega leggera dimensioni m. 3x2 - 4x2 - 6x2

Available 2 SIDE GOALS in light alloy dimensions m. 3 x 2 - 4 x 2 - 6 x 2

pg.27

848,00€

Art. 084.8

Porta bifrontale m. 4 x 2

in lega leggera sezione tubo 80 mm. completa di rete

Two Side Goal 4 x 2 m. in light alloy pipe 80 mm. net included

Art. 083

Porta bifrontale m. 6 x 2

in lega leggera sezione tubo 80 mm. completa di rete

Two Side Goal 6 x 2 m. in light alloy pipe 80 mm. net included

543,00€



MINI PORTE Mini-goals



Coppia porte minicalcio professionali in acciaio verniciato tubo sezione mm. 80 dimensioni cm. 90x60 complete di reti
Pair of professional steel mini football goals pipe 80 mm. dimensions 90x60 cm. nets included

ATTENZIONE: in caso di ordine errato da parte del Cliente le porte, una volta consegnate, non possono essere rese



Coppia porte minicalcio in acciaio verniciato m. 1,5 x 1 complete di reti e picchetti
Pair of mini football goals 1,5 x 1 m. in painted steel pegs and nets included



Coppia porte minicalcio in acciaio verniciato m. 1,5 x 1 complete di reti e picchetti
Pair of mini football goals 1,5 x 1 m. in painted steel pegs and nets included



Coppia porte minicalcio m. 1,5 x 1,1 in PVC rinforzato tubo Ø mm. 70 complete di reti e picchetti
Pair of PVC mini football goals 1,5 x 1,1 m. pipe Ø 70 mm. pegs and nets included



258,00€

Art. 124
Coppia porte minicalcio in polipropilene
m. 1,5 x 1,1 tubo Ø mm. 40 complete di reti
Pair of polypropylene mini football goals 1,5 x 1,1 m.
pipe Ø 40 mm. - nets included



Dimensioni porta ribaltata m. 1,5 x 0,80
Goal upside down dimensions 1,5 x 0,80 m.



250,00€

Art. A124
Coppia porte minicalcio in alluminio m. 1,5 x 1,1
tubo Ø mm. 32 complete di reti
Pair of aluminium mini football goals 1,5 x 1,1 m.
pipe Ø 32 mm. - nets included



Dimensioni porta ribaltata m. 1,5 x 0,80
Goal upside down dimensions 1,5 x 0,80 m.

pg.27



Art. PUG

87,75€

Coppia porte minicalcio in nylon
m. 1,83 x 1,07
complete di reti,
picchetti e borsa
Pair of nylon mini football goals
1,83 x 1,07 m.
nets, pegs and bag included

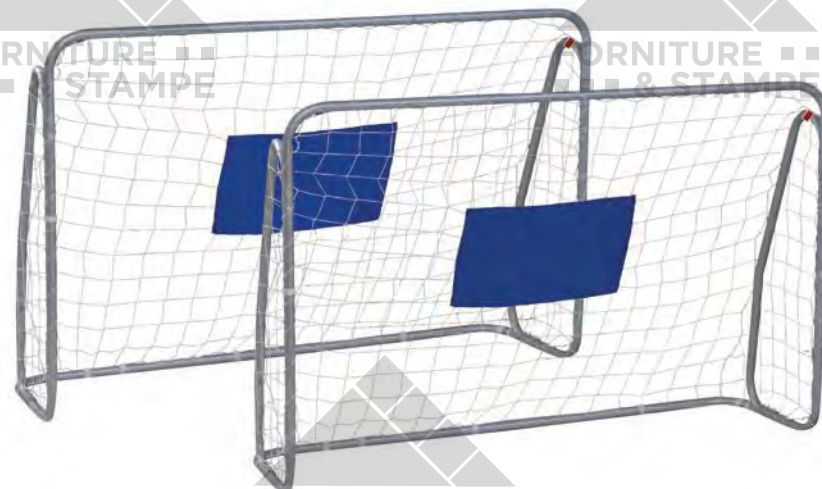

191,00€

Art. POR-14
Coppia porte minicalcio
m. 2,15 x 1,52 in acciaio verniciato
complete di reti
Pair of steel mini football goals
2,15 x 1,52 m. - nets included

PORTA MINICALCIO CM.150x90 PIEGHEVOLE - Foldable 150x90 cm. mini football goal



264,00€

pg.27

Art. BG150



Questa porta minicalcio pieghevole consente ad allenatori e giocatori di concentrarsi sugli esercizi fondamentali poiché per il montaggio sono richiesti solo 10 secondi. Il telaio facilmente trasportabile è durevole, sicuro e realizzato con una struttura in PVC resistente al calore. Esso è dotato di bobine progettate per tornare in posizione dopo una pallonata e, soprattutto, la porta rimane stabile senza necessità di ancoraggio a terra grazie al sistema a molla integrato.

A differenza di molte porte da calcio in metallo comunemente usate, questa porta minicalcio in PVC è totalmente sicura e previene il rischio di infortuni qualora un giocatore andasse a sbatterci contro.

La rete della porta a tecnologia telescopica brevettata può essere personalizzata. È possibile infatti stamparvi il logo della propria squadra di modo che la porta diventi un utile strumento di marketing per le società sportive, ma anche per i partners esterni delle società stesse che desiderano investire in sponsorizzazioni smart.

La porta minicalcio pieghevole può essere utilizzata sulle diverse tipologie di superfici (erba, sabbia, cemento, legno). Non ha bisogno di borsa dato che la sua resistente rete funge anche da rivestimento.

La porta minicalcio da 150 cm x 90 cm si riduce ad una dimensione compatta di 180 cm x 15 cm x 10 cm, e le comode cinghie rendono il trasporto agevole visto che il peso è di soli 7 chilogrammi.

Le porte minicalcio pieghevoli vengono utilizzate quotidianamente presso alcune delle più rinomate accademie e scuole calcio di club professionistici tra cui Chelsea, Barcellona, Ajax, Arsenal, Manchester United, Liverpool ed Everton. Sono approvate e raccomandate dalla Federcalcio catalana in Spagna, dalla Federazione norvegese, nonché dall'Oregon Youth Soccer Association.



SI INSTALLA
IN 10 SECONDI
READY IN 10
SECONDS

LEGGERA E
COMODA PER
IL TRASPORTO
LIGHT AND
COMFORTABLE
FOR TRANSPORT

CON RETE
PERSONALIZZABILE
WITH
CUSTOMIZABLE
NET



This foldable mini football goal allows coaches and players to focus on core exercises as only 10 seconds are required for assembly. The easily transportable frame is durable, safe and made with a heat resistant PVC construction. It's equipped with coils designed to return to position after a ball hit and, above all, the goal remains stable with no need to be anchored to the ground thanks to the integrated spring system.

Unlike many commonly used metal soccer goals, this PVC mini football goal is totally safe and prevents the risk of injury should a player bump into it.

The patented telescopic goal net can be customized. In fact, it's possible to print the logo of your team so that the goal becomes a useful marketing tool for sports clubs, but also for external partners who wish to invest in smart sponsorships.

The foldable mini football goal can be used on different surfaces (grass, sand, concrete, wood). It does not need a bag as its durable net also acts as a covering.

The 150 cm x 90 cm mini football goal is reduced to a compact size of 180 cm x 15 cm x 10 cm, and the comfortable straps make transport easy as the weight is only 7 kilograms.



Foldable mini football goals are used daily at some of the most renowned academies and soccer schools of professional clubs including Chelsea, Barcelona, Ajax, Arsenal, Manchester United, Liverpool and Everton. They are approved and recommended by the Catalan Football Association in Spain, the Norwegian Federation, as well as the Oregon Youth Soccer Association.

RETI REGOLAMENTARI colore bianco - White color official size Nets

Le reti a maglia esagonale sono tessute, quelle a maglia quadrata sono annodate (eccetto Art. B011)
 Square mesh nets are knotted (except Art. B011)

Profondità: la prima grandezza indica la sporgenza posteriore della rete ad altezza traversa, la seconda grandezza indica la sporgenza posteriore a terra

Depth: the first figure indicates the rear depth of the net at crossbar level, the second figure indicates the rear depth at ground



555,00€

Art. B011
 polipropilene mm.5
 maglia mm.120 mesh
 colore bianco
 white
 certificate FIGC/LND
 certified
 profondità
 cm.200x200 depth

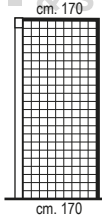
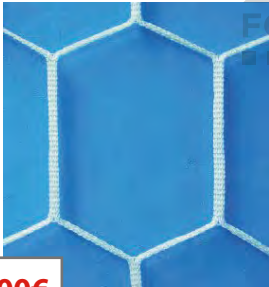
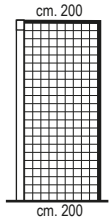
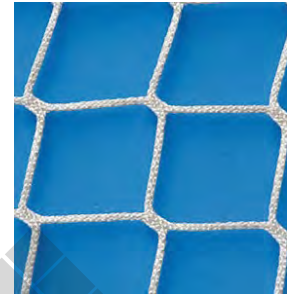

236,00€

Art. 125
 polipropilene mm. 4
 profondità
 cm.170x170 depth

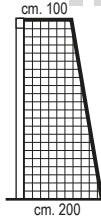
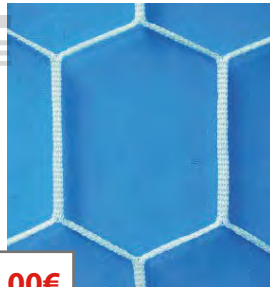

255,00€

Art. 126
 poliestere mm. 5
 profondità
 cm.100x200 depth

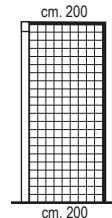

411,00€

Art. 127
 polipropilene mm. 5
 profondità
 cm.200x200 depth

pg.27 pg.28

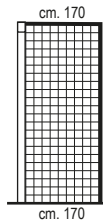
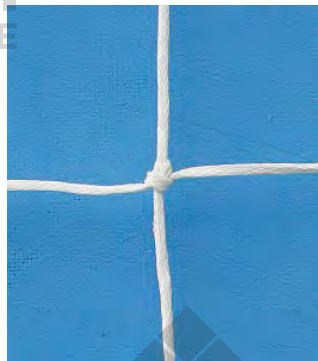

157,00€

Art. B003
 polietilene
 mm. 2,5
 profondità
 cm.170x170
 depth

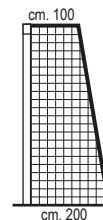

197,00€

Art. B19
 polietilene
 mm. 3,5
 profondità
 cm.100x200
 depth

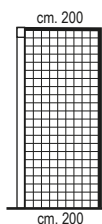
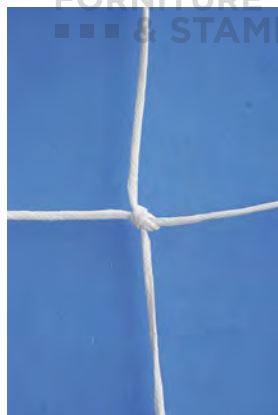

235,00€

Art. 128E
 polietilene
 mm. 3,5
 profondità
 cm.200x200
 depth

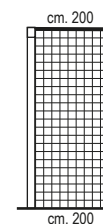

302,00€

Art. 128
 polietilene
 mm. 4,5
 profondità
 cm.200x200
 depth



Art. 128FR

RETI REGOLAMENTARI colorate
Striped official size Nets



Art. 128FR Coppia reti annodate in polietilene mm.4 bianche o a strisce colorate (bianco/royal, bianco/rosso, giallo/royal) profondità cm.100x250 depth

1235,00€

Pair of nets polyethylene 4 mm. color stripes, knotted (available in white, white/royal, yellow/royal, white/red)

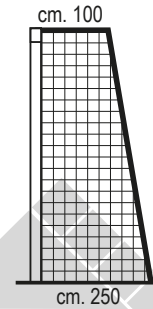

pg.28

ITURE ■ ■
STAMPE

FORNITURE ■ ■
■ ■ ■ & STAMPE

FORNITURE ■ ■
■ ■ ■ & STAMPE

230,00€

Art. 128C Coppia reti annodate in polietilene mm. 3,5 a strisce colorate (bianco-royal, bianco/rosso, giallo/royal, rosso/blu, bianco/nero, bianco/verde) profondità cm. 200x200 depth

Pair of nets polyethylene 3,5 mm. color stripes, knotted (available in white/royal, yellow/royal, white/red, white/black, white/green, red/blue)

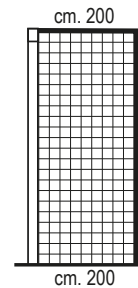

778,00€

Art. 129T

Coppia reti polipropilene mm. 4 annodate a mano a strisce colorate (bianco/viola, rosso/nero, giallo/rosso, giallo/verde, giallo/nero, arancio, tricolore Italia, Tim Cup a strisce verticali) profondità cm. 200x200 depth

Pair of nets with color stripes, hand knotted in various combinations

914,00€

Art. 129T.SP

Coppia reti polipropilene mm. 4 annodate a mano a strisce colorate (qualsiasi combinazione di colori a richiesta) profondità cm. 200x200 depth

Pair of nets with color stripes, hand knotted any combination

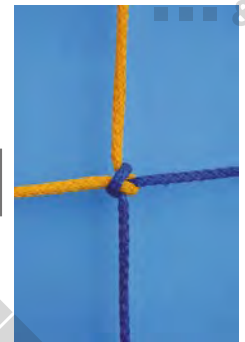

FORNITURE ■ ■
■ ■ ■ & STAMPE

ITURE ■ ■
STAMPE

RETI RIDOTTE - Reduced size Nets - m.6x2,2/m.6,5x2,5

142,90€

Art. 131.22
Coppia Reti
m. 6x2,2
annodate in polietilene mm. 3,5 profondità cm.100x160

Pair of knotted nets 6x2,20 m. polyethylene thickness 3,5 mm. 100x160 cm. depth

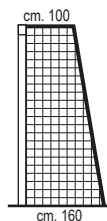

pg.28

Art. 131.5
Coppia Reti
m. 6,50x2,50
in polipropilene mm. 4

profondità cm.120x120
Pair of nets 6,50x2,50 m. polypropylene thickness 4 mm. 120x120 cm. depth

206,90€

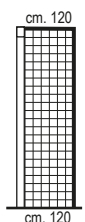
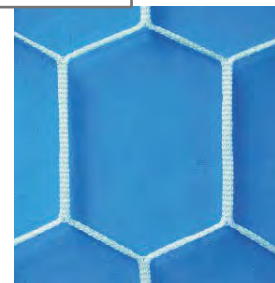

FORNITURE ■ ■
■ ■ ■ & STAMPE

FORNITURE ■ ■
■ ■ ■ & STAMPE

RETI RIDOTTE - Reduced size Nets - m.6x2/m.5x2/m.4x2

Profondità: la prima grandezza indica la sporgenza posteriore della rete ad altezza traversa, la seconda grandezza indica la sporgenza posteriore a terra
Depth: the first figure indicates the rear depth of the net at crossbar level, the second figure indicates the rear depth at ground

110,40€



100,00€

Art. 131N m. 6x2 / Art. 132N m. 5x2

Coppia Reti annodate in polietilene mm. 2,5 profondità cm.120x120

Pair of knotted nets 6x2 m. / 5x2 m. polyethylene thickness 2,5 mm. 120x120 cm. depth

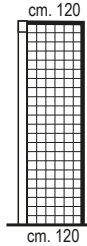

pg.28

141,00€

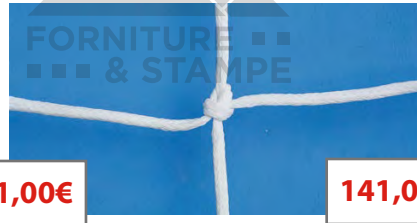

141,00€

Art. B170 m. 6x2 / Art. B171 m. 5x2

Coppia Reti annodate in polietilene mm. 3,5 profondità cm.100x160

Pair of knotted nets 6x2 m. / 5x2 m. polyethylene thickness 3,5 mm. 100x160 cm. depth

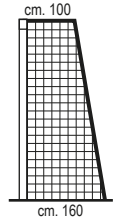

125,40€



Art. 133 Coppia Reti m. 4x2 in polipropilene mm. 4

profondità cm. 120x120
 Pair of nets 4x2 m. polypropylene thickness 4 mm. 120x120 cm. depth

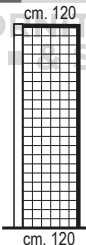

pg.28

84,90€



Art. 133SN Coppia Reti m. 4x2 annodate in polietilene mm. 2,5

profondità cm. 100x100
 Pair of knotted nets 4x2 m. polyethylene thickness 2,5 mm. 100x100 cm. depth

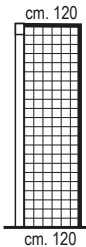
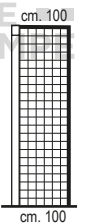

Art. 133LR Coppia Reti m. 4x2 annodate in polietilene spessore mm. 3,5

profondità cm.120x120
 Pair of knotted nets 4x2 m. polyethylene thickness 3,5 mm. 120x120 cm. depth

111,60€

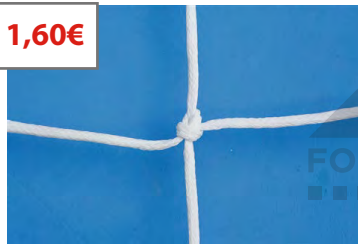

Art. 133NP Coppia Reti m. 4x2 annodate in polietilene spessore mm. 3,5

profondità cm.100x160
 Pair of knotted nets 4x2 m. polyethylene thickness 3,5 mm. 100x160 cm. depth

107,70€

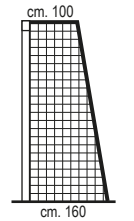

RETI RIDOTTE COLORATE - Striped reduced size Nets - m.6x2/m.5x2/m.4x2

243,75€

220,00€

177,45€

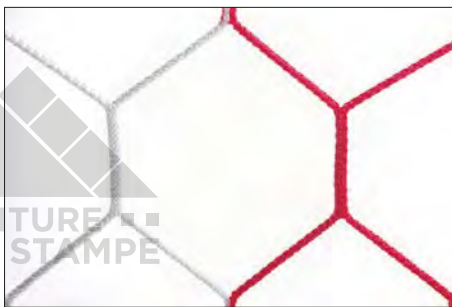

Art. 62BR m.6x2 profondità cm.100x160 depth
Art. 52BR m.5x2 profondità cm.100x160 depth
Art. 42BR m.4x2 profondità cm.120x120 depth
Coppia Reti a maglia esagonale in polipropilene ø mm. 4 colorate a strisce bianco/rosse
 Pair of white/red nets polypropylene thickness 4 mm. hexagonal mesh

pg.28

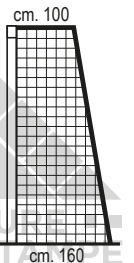

232,00€

204,75€

160,00€

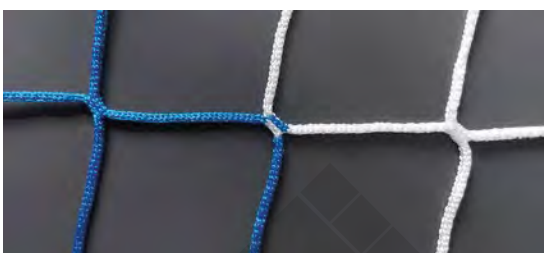

Art. 62BA m.6x2 profondità cm.100x160 depth
Art. 52BA m.5x2 profondità cm.100x160 depth
Art. 42BA m.4x2 profondità cm.120x120 depth
Coppia Reti a maglia quadrata in polipropilene ø mm. 4 colorate a strisce bianco/azzurre
 Pair of white/royal nets polypropylene thickness 4 mm. square mesh

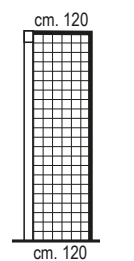

RETI CALCETTO - Futsal Nets m. 3x2

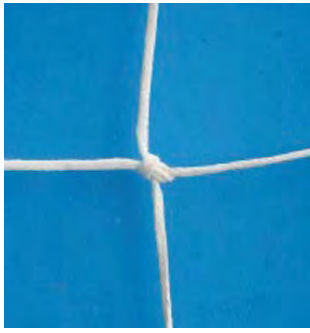

Art. 134E **85,00€**
Coppia reti m.3x2 annodate in polietilene spessore mm.2,5
 Pair of 3x2 m. nets knotted polyethylene thickness 2,5 mm.

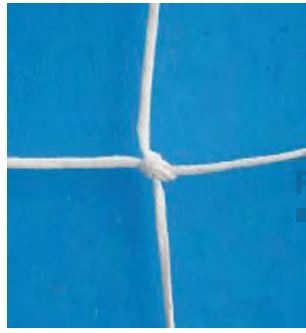

102,80€
Art. 135C
Coppia reti m.3x2 annodate in polietilene spessore mm.3,5
 Pair of 3x2 m. nets knotted polyethylene thickness 3,5 mm.

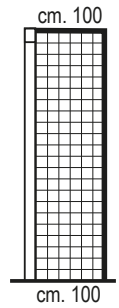

pg.29

Profondità cm.100x100
 Depth: 100x100 cm.

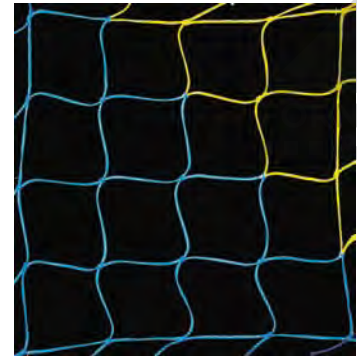

Art. 135FR **Coppia reti m.3x2 annodate in polietilene spessore mm.3 colori: bianco/royal, bianco/rosso, giallo/royal**
 Pair of 3x2 m. nets knotted polyethylene thickness 3 mm. colors: white/royal, white/red, yellow/royal

125,75€



pg.29

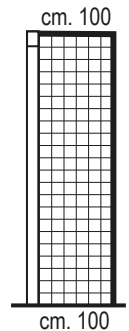
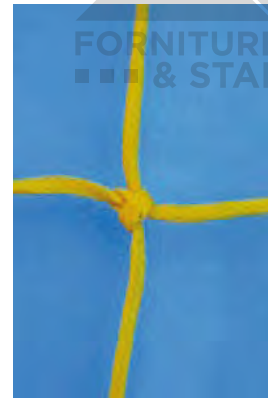

Art. 135 **Coppia reti m.3x2 annodate in polietilene spessore mm.4,5 colori: bianco, rosso, giallo**
 Pair of 3x2 m. nets knotted polyethylene thickness 4,5 mm. colors: white, red, yellow

150,75€



pg.29

Art. 137 **49,75€**
Coppia reti m.1,5x1,1 per porte minicalcio
 Pair of nets 1,5x1,1 m. for mini football goals

RETI PER CALCI DI PRECISIONE - Precision shooting nets

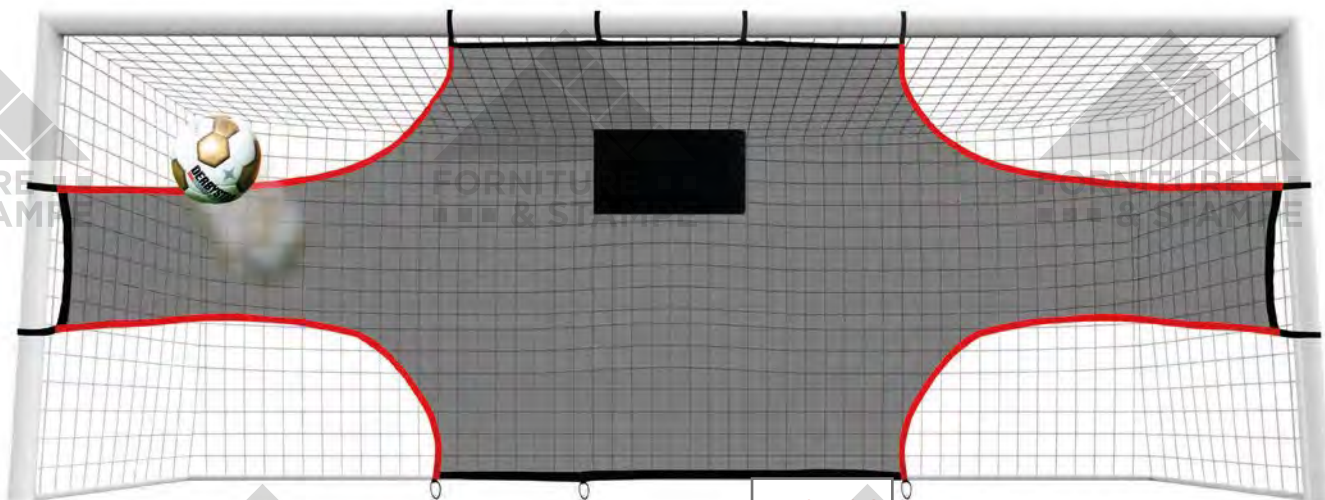

Art. PTI.732

140,40€

pg.29

Rete per calci di precisione per porta regolamentare completa di fasce con velcro per fissaggio a pali e traversa e picchetti per ancoraggio a terra
Precision shooting net for regular size goal complete with velcro straps for fixing to poles and crossbar and pegs for ground anchoring

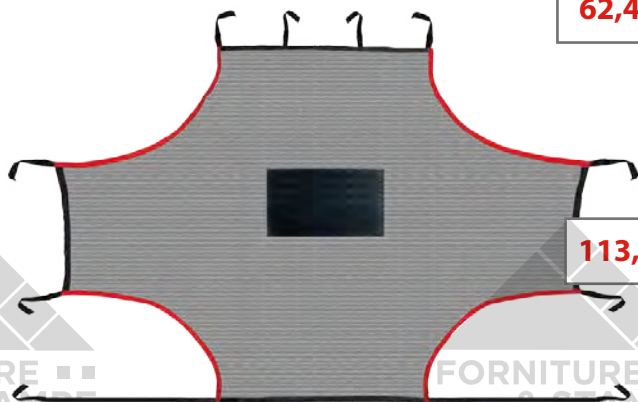

62,40€

Art. PTI.275

pg.29

Rete per calci di precisione per porta m.3x2 completa di fasce con velcro per fissaggio a pali e traversa e picchetti per ancoraggio a terra
Precision shooting net for 3x2 m. goal complete with velcro straps for fixing to poles and crossbar and pegs for ground anchoring

113,00€

Art. PTI.520

Rete per calci di precisione per porta m.5x2 completa di fasce con velcro per fissaggio a pali e traversa e picchetti per ancoraggio a terra
Precision shooting net for 5x2 m. goal complete with velcro straps for fixing to poles and crossbar and pegs for ground anchoring

pg.29

4 tasche bersaglio per calci di estrema precisione



4 target pockets for very accurate shootings

Basta raccogliere palloni in fondo al sacco, lascia che sia la palla a tornare da te!

Stop picking up balls all the time, let the ball come back to you!

193,00€

Art. GM

Rete per calci di precisione con 4 tasche per porta regolamentare completa di corda elastica e picchetti
Precision shooting net with 4 accuracy pockets including elastic rope and pegs for regular size goal

146,00€

Art. GM42

Rete per calci di precisione con 4 tasche per porta m. 4x2 completa di corda elastica e picchetti
Precision shooting net with 4 accuracy pockets including elastic rope and pegs for 4x2 m. goal

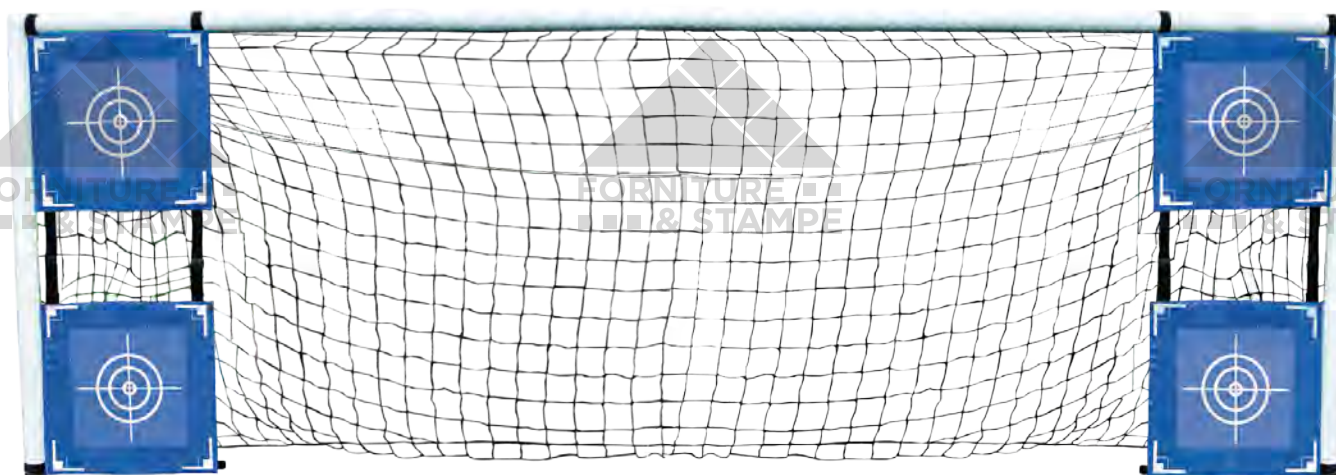

pg.29

109,00€

Art. SF4106

Set di 4 bersagli per calci di precisione applicabili a porte di qualsiasi dimensione

Set of 4 targets for precision shooting applicable to soccer goals of any size

Particolare di un bersaglio
Detail of a target

pg.7

109,00€

Art. QBFG

CROSS TRAINING
rete bersaglio sempre in piedi
per allenamento alla precisione del cross,
del lancio in profondità,
del rinvio del portiere

CROSS TRAINING
movable target to improve crossing,
long passing and GK kicks precision

Il bersaglio ha dimensioni cm.120x120,
ha una inclinazione regolabile da
orizzontale a quasi verticale ed è in grado
di ricevere la palla ad altezze comprese
tra cm.175 e cm.262

senza mai cadere a terra
base in alluminio, peso Kg.10
facilmente spostabile sul campo

The basket is adjustable from horizontal to
nearly vertical, height adjustable from 175
to 262 cm. - aluminium base, weight 10 Kg.
very easy to move on the field, never falls
down when hit by the ball



RETI DI PROTEZIONE - Protection nets



TUTTE LE RETI DI PROTEZIONE VENGONO REALIZZATE SU MISURA IN BASE ALLE RICHIESTE DEL CLIENTE IN CIRCA 10 GIORNI

All protection nets are manufactured according to Customer's needs in about 10 days

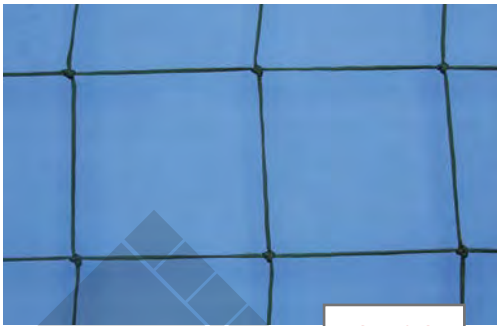

● pg.29

Art. 093N **2,70€**
Rete protezione polietilene verde annodata
maglia cm. 13x13 spessore mm.2,5
(per calcio e calcetto)
Protection Net green polyethylene mesh
13x13 cm. knotted, thickness 2,5 mm.
(for football and futsal)



Art. 093.5 **3,20€**
Rete protezione polietilene verde annodata
maglia cm. 13x13 spessore mm.3,5
(per calcio e calcetto)
Protection Net green polyethylene mesh
13x13 cm. knotted, thickness 3,5 mm.
(for football and futsal)



Art. 0934N **3,30€**
Rete protezione polietilene verde annodata
maglia mm. 45x45 sp. mm.2
(per tennis e baseball)
Protection Net green polyethylene mesh
45x45 mm. knotted, thick 2 mm.
(for tennis and baseball)

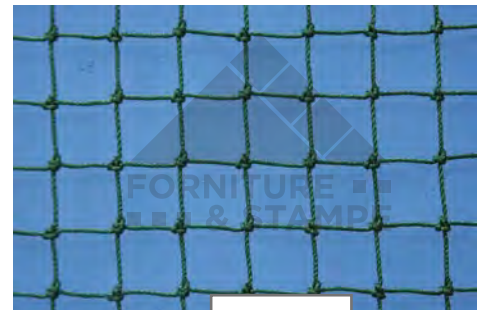

Art. R57 **5,70€**
Rete protezione polietilene verde annodata
maglia mm. 25x25
spessore mm.2 (per golf)
Protection Net green polyethylene mesh
25x25 mm. knotted thick 2 mm. (for golf)



Art. R55 **4,60€**
Rete protezione polietilene nera annodata
maglia mm. 18x18
spessore mm.2
(antioggetto/antipetardo)
Protection Net anti-objects and fire crackers

● I numeri in giallo indicano la pagina di riferimento del Listino Prezzi 2024-2025

PANCHINE ALLENATORI - Trainers' dug-outs



Art. V6230/.../V6234.8
 Panchina allenatori
 profilo curvato
 mm. 50x30 in acciaio
 zincato a caldo
 rivestimento
 posteriore e laterale
 in policarbonato
 alveolare non
 trasparente spessore
 mm. 4,
 piano di seduta con
 scocche in
 polipropilene montate
 su telaio zincato
 Dug-out in galvanized
 steel with non
 transparent alveolar
 protection

FORNITURE ■ ■
 ■ ■ ■ & STAMPE

Altezza tettuccio cm. 200, profondità fianco laterale cm. 88

pg.30

Art. V6220/.../V6224.8
 Panchina allenatori
 profilo curvato
 mm. 50x30 in acciaio
 zincato a caldo
 rivestimento
 posteriore e laterale in
 policarbonato
 trasparente spessore
 mm. 3, piano di seduta
 con scocche in
 polipropilene montate
 su telaio zincato
 Dug-out in galvanized
 steel with transparent
 alveolar protection



Art. V6285

Protezione in poliuretano espanso
 per bordo panchina allenatori
 con profilo mm. 50x30
 Polyurethane protection for dug-out's edge

FORNITURE ■ ■
 ■ ■ ■ & STAMPE

FORNITURE ■ ■
 ■ ■ ■ & STAMPE

FORNITURE ■ ■
 ■ ■ ■ & STAMPE

FORNITURE ■ ■
 ■ ■ ■ & STAMPE

FORNITURE ■ ■
 ■ ■ ■ & STAMPE

I numeri in giallo indicano la pagina di riferimento del Listino Prezzi 2024-2025



Altezza tettuccio cm. 200
 profondità fianco laterale cm. 74
 Roof height 200 cm. - side depth 74 cm.



Art. 155AV/156AV/157AV/158AV/159AV/159.7AV/159.8AV/155AV4

Panchina allenatori con struttura in tubo quadro in lega d'alluminio mm. 30x30 con copertura in policarbonato alveolare non trasparente - fianchi laterali in policarbonato trasparente (2 scocche di seduta in polipropilene per ogni metro di lunghezza)
 Dug-out in light alloy square pipe mm. 30x30 with non transparent alveolar protection
 Transparent protection on both sides (2 polypropylene seats per every meter of length)

pg.31



Art. 162
 Protezione in poliuretano per bordo panchine
 Polyurethane protection for dug-out's edge



Art. PSG1/PSG2/PSG3

Piano di seduta con scocche in polipropilene montate su supporto in acciaio zincato da fissare a terra (identico a quello fornito con le panchine allenatori serie Art. 155AV e Art. 155)
 lunghezza m.1 con 2 scocche di seduta
 lunghezza m.2 con 4 scocche di seduta
 lunghezza m.3 con 6 scocche di seduta
 Seating support mounted on a galvanized frame

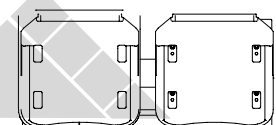
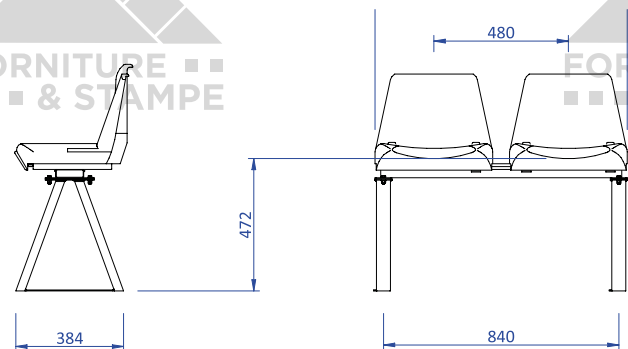
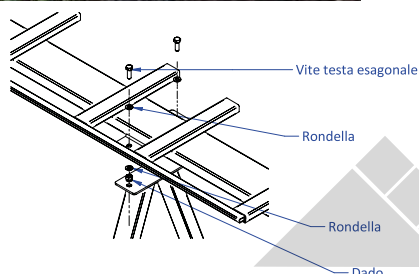

Numbers in yellow show the relevant page on 2024-2025 Price List

I numeri in giallo indicano la pagina di riferimento del Listino Prezzi 2024-2025



Altezza tettuccio cm. 200 profondità fianco laterale cm. 74
Roof height 200 cm. - side depth 74 cm.



Art. 155/156/157/158/159/159.7/159.8/155-4

Panchina con struttura in tubo quadro in lega d'alluminio mm. 30x30 con copertura in policarbonato trasparente e scocche di seduta in polipropilene (2 scocche di seduta per ogni metro di lunghezza)
Dug-out in light alloy square pipe mm. 30x30 with transparent polycarbonate protection (2 polypropylene seats per every meter of length)

pg.31

La verniciatura con colore a richiesta del tubo quadro in alluminio comporta una maggiorazione del prezzo del 10%
Optional painting of the square pipe frame in aluminium (color on request): 10% additional charge on selling price



pg.32

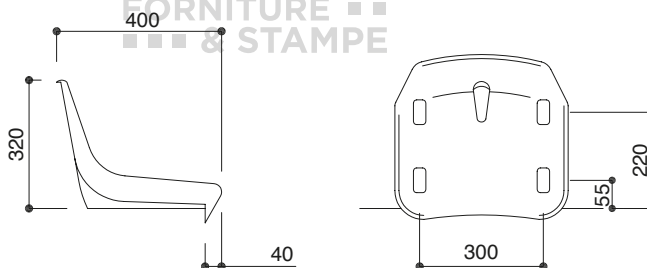

Art. M2010
Seduta ricambio per panchina allenatori (nuovo modello) colore rosso o blu
Spare Seat for Dug-Outs (new model) in red or blue color



Art. ASBI
Seduta ricambio per panchina allenatori (vecchio modello) colore rosso o blu fissaggio con 4 viti
Spare Seat for Dug-Outs (previous model) in red or blue color fixing with 4 screws

pg.31

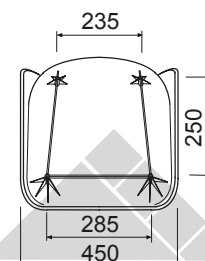
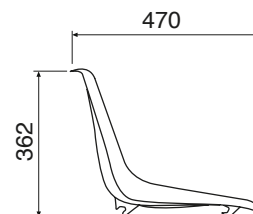

È necessario fissare le panchine su una base in cemento tramite tasselli: la base dovrà essere più estesa di circa 30 cm. per ciascun lato rispetto alla lunghezza e alla profondità della panchina
It is necessary to anchor dug-outs upon concrete base. Size of concrete base must be about 60 cm. longer and deeper than dug-out perimeter size (30 cm. longer and wider on each of the 4 sides)

● I numeri in giallo indicano la pagina di riferimento del Listino Prezzi 2024-2025

PANCHINE ALLENATORI IDEALI PER CAMPI CALCETTO Trainers' dug-outs for futsal pitches



Art. V6242.2 / V6242.3 / V6241.2 / V6241.3

Panchina allenatori profilo curvato mm. 40x20 in lega di alluminio, rivestimento posteriore e laterale in policarbonato alveolare sp. mm. 4 profondità a terra cm. 97, altezza massima cm. 208 lunghezza metri 2 oppure metri 3 con panca sedute in acciaio zincato e legno o con panca sedute in alluminio anodizzato

Dug-out curved profile 40x20 mm. in light alloy, rear and side coverings in non transparent polycarbonate 4 mm. thick soil depth 97 cm. maximum height 208 cm. 2 meters or 3 meters length with wooden bench on galvanized steel or with bench in anodized aluminium

pg.32



Art. V6291 / V6292

Panchina allenatori trasportabile su ruote profilo curvato mm. 50x30 in lega di alluminio rivestimento posteriore e laterale in policarbonato alveolare sp. mm. 4 oppure in policarbonato trasparente sp. mm. 3, profondità a terra cm. 150 altezza utile cm. 210 lunghezza metri 3 con supporto sedute in acciaio zincato e 6 scocche in polipropilene con piano borse sul retro dei seggiolini

Dug-out transportable on wheels curved profile 50x30 mm. in light alloy rear and side coverings in non transparent polycarbonate mm. 4 thick or in transparent polycarbonate mm. 3 thick, depth on the ground 150 cm. useful height 210 cm. length 3 meters with galvanized steel seat support and 6 polypropylene seats with back space for bags



● I numeri in giallo indicano la pagina di riferimento del Listino Prezzi 2024-2025



New!



Profondità fianco laterale cm.150
Side depth 150 cm.

**Ordinabile anche nel modello fisso
senza ruote**
Fixed model with no wheels on request



pg.32

Art. V6293 / V6294

**Panchina allenatori trasportabile su ruote lunghezza metri 3
profilo curvato mm.50x30 in lega di alluminio - altezza utile cm.210
copertura in policarbonato alveolare mm.4 oppure in policarbonato trasparente mm.3
sedute su 2 file (11 posti in totale)**

Transportable dug-out on wheels length 3 meters
aluminium alloy frame 50x30 mm. - height 210 cm.

4 mm. non transparent polycarbonate cover or 3 mm. transparent polycarbonate cover
seating in 2 rows (11 seats in total)



Art. S04910

**Panchina bordo campo
struttura in acciaio zincato
lunghezza cm. 200
con 4 scocche di seduta in polipropilene colorato**
4 Sideline seats on galvanized steel frame
length 200 cm.

pg.42

● I numeri in giallo indicano la pagina di riferimento del Listino Prezzi 2024-2025



Art. 155FZ2/155FZ4/155FZ6/155FZ8

Panchina allenatori in acciaio zincato a caldo rinforzato profilo mm. 40x40 con profondità cm.180 (misurando da tettuccio a limite base posteriore di appoggio) rivestita con lastre in policarbonato trasparente spessore mm. 3 piano di seduta con scocche in polipropilene

Dug-Out in galvanized steel pipe 40x40 mm. - 180 cm. depth (from back protection to edge of roof)
transparent polycarbonate 3 mm. thick back cover - polypropylene seats on steel frame (2 seats each meter)



pg.31 pg.32

Art. 155PR

Rivestimento di protezione in schiumato per tettuccio e montanti
Soft edge protections



Art. LXR2/LXR4/LXR6/LXR8

Panchina allenatori in tubo di acciaio zincato a caldo profilo mm. 40x40 TRASPORTABILE su ruote - copertura in policarbonato trasparente profondità cm. 135 piano di seduta con scocche in polipropilene

Dug-Out in galvanized steel pipe 40x40 mm. - TRANSPORTABLE on wheels
transparent polycarbonate back cover, polypropylene seats

● Numbers in yellow show the relevant page on 2024-2025 Price List

● I numeri in giallo indicano la pagina di riferimento del Listino Prezzi 2024-2025

PANCHINE LUSO CON POLTRONE IN ECOPELLE - Leather seat dug-outs



FORNITURE ■ ■ ■
& STAMPE

PREVENTIVO SU RICHIESTA
PRICES ON REQUEST

FORNITURE ■ ■ ■
& STAMPE

FORNITURE ■ ■ ■
& STAMPE



FORNITURE ■ ■ ■
& STAMPE

FORNITURE ■ ■ ■
& STAMPE



Modelli fissi o trasportabili
struttura in acciaio zincato
poltrone in ecopelle personalizzabili
Fixed or transportable Dug-Outs
galvanized steel frame
customizable leather seats

FORNITURE ■ ■ ■
& STAMPE

FORNITURE ■ ■ ■
& STAMPE

FORNITURE ■ ■ ■
& STAMPE

CARRELLI TRACCIALINEE - Line markers



Per una resa ottimale e per evitare inconvenienti utilizzare sempre carbonato di calcio asciutto, ovvero la comune polvere di marmo

For optimal performance always use dry calcium carbonate, that is the common marble dust

Art. 142S **444,00€**

Carrello traccialinee a polvere

Marble Powder Line Marker

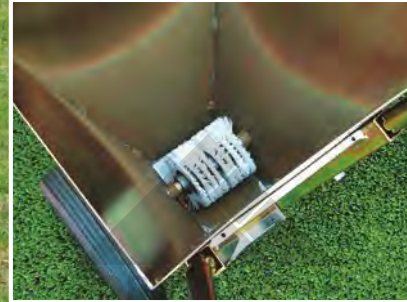

pg.29



UTILIZZARE SOLTANTO VERNICE ECOLOGICA ATOSSICA E PULIRE DOPO OGNI USO IL SERBATOIO E TUTTO IL CIRCUITO DI SPRUZZO FINO AGLI UGELLI (occorre spruzzare ripetutamente acqua prima di riporre l'attrezzo)
Always use ecological paint and wash with water after use (put water in the tank and spray)

534,00€

Art. 144

Carrello traccialinee a vernice ecologica con serbatoio munito di pompante a pressione manuale
Paint Line Marker with manual pressure tank



New!

pg.30

Art. 145 **1852,00€**

Carrello traccialinee a vernice ecologica con motore a scoppio a 4 tempi - marcatura CE serbatoio vernice litri 23 tracciatura laterale regolabile
Paint Line Marker with 4 stroke engine 23 liter tank



1110,00€

Art. 144.EL
Carrello traccialinee a vernice elettrica
completo di caricabatteria
(per la batteria della pompa elettrica)
capacità serbatoio litri 18
tracciatura laterale regolabile

Electric Line Marker
complete with battery charger 18 liter tank
adjustable lateral marking device

pg.30

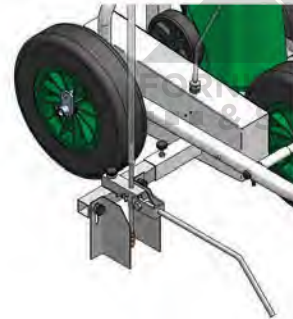

54,40€

Art. F211
Mirino in acciaio zincato per carrelli
traccialinee Art. 144.EL e Art. 145
Foresight in galvanized steel for line markers
Art. 144.EL and Art. 145

pg.29

1131,00€

Art. 144.SL

Carrello traccialinee a rulli
senza serbatoio a pressione.

Tramite la rotazione
dei rulli la vernice viene prelevata
all'interno del serbatoio
e spalmata sull'erba

Roller Paint Line Marker
Just fill up the tank with paint
and push the machine.

Taking advantage of rolling wheels,
paint flows from tank down to grass
the easiest way!





65,80€

Art. 146E

Vernice Ecologica atossica per manti erbosi

Biancostadio lt. 17 - Kg. 19

Ecological Paint for grass 17 liters - 19 Kg.

100,25€

BIANCA

109,00€

GIALLA

Art. 146BP/146BPG

Vernice bianca o gialla per manti sintetici a

bassa permanenza (1 settimana) 17 litri

Paint for artificial grass white or yellow color, short durability (1 week) 17 liters



10,70€

Art. NS200

Rotolo nastro stradale mt. 200 - bianco/rosso
Red/White Tape length 200 meters



66,00€

Art. NTESA
Rotolo Nastro adesivo mt. 50 - larghezza cm. 5 vari colori per tracciatura righe su superfici sintetiche
Tape for bounds 50 meter - 5 cm. width

94,15€

Art. SIFS

Fettuccia segnasettore in materiale sintetico impermeabile colore bianco o rosso larghezza mm. 50 in rotoli da mt. 25 (chiodi inclusi)

Sector line in waterproof synthetic fabric, width 50 mm. length 25 m. color white or red (pegs included)



pg.30

330,00€

Art. 146LP/146LPG

Vernice bianca o gialla per manti sintetici a

lunga permanenza (3 mesi) 17 litri,

da utilizzare solo con carrello a rulli
Paint for artificial grass white or yellow color, long durability (3 months) 17 liters

New!



164,80€

Art. RC100

Bobina con fettuccia elastica per delimitazione temporanea campo da gioco.

Con questo nastro la marcatura può essere comodamente installata su campi senza gesso o vernice, e può essere rimossa senza lasciare residui dopo una partita o un allenamento. Il nastro può essere facilmente srotolato dalla bobina, e poi riavvolto con la stessa facilità. Lunghezza 100 metri (ma può estendersi fino a circa il doppio)

Larghezza cm. 2,5 - colore bianco
25 picchetti in plastica inclusi per il fissaggio

Spool with elastic tape for temporary delimitation of the playing field. With this tape the marking can be conveniently installed on pitches with no chalk or paint, and can be removed without leaving residue after a match or training. The tape can be easily unwound from the spool, and then rewound just as easily.

Length 100 meters (but can extend to approximately double that)

Width 2,5 cm. - white color
25 plastic pegs included for fixing

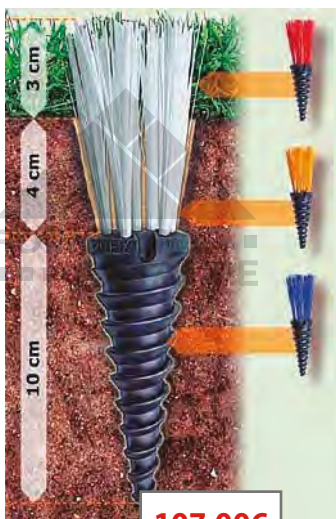

107,00€

Art. PFIx Plifix

Picchetto di riferimento permanente con erba sintetica bianca o colorata per agevolare la tracciatura delle righe dei campi da gioco o per delimitare aree

Confezione da 25 pezzi incluso utensile in plastica

Plifix - permanent peg with artificial white or coloured grass to help tracing lines on the field or mark areas - 25 pieces set includes also plastic planting device



SEDUTE PER GRADINATE - Stadium seats

COLORI DISPONIBILI: blu, rosso, giallo, verde, bianco, nero, grigio
AVAILABLE COLORS: blue, red, yellow, green, white, black, grey

ORDINE MINIMO 10 PEZZI PER MODELLO E COLORE
 Minimum quantity 10 pieces per model and color

**ATTENZIONE:
 NON PER PANCHINE
 ALLENATORI!
 NOT FOR TRAINERS'
 DUG-OUTS!**



Art. M2003/M2003A

Art. M2003 Seduta in polipropilene con schienale ignifuga e antiultravioletti (secondo normativa UEFA) fissaggio diretto sulla gradinata con tasselli (non inclusi)
 Polypropylene Seat non ignitable and anti-ultraviolet rays with back rest (according to UEFA requirements) to be fixed with screws (not included)

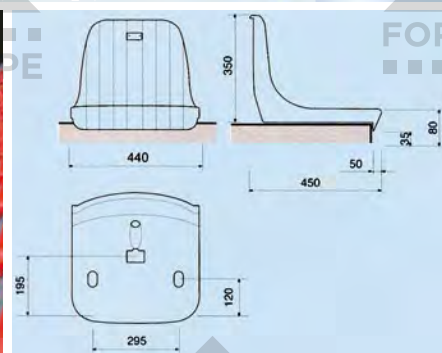
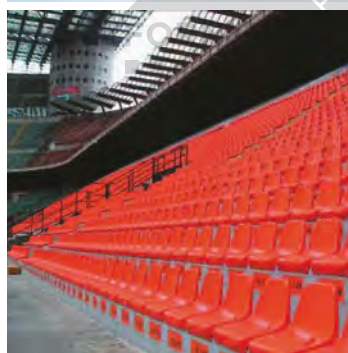

Art. M2003A Seduta in polipropilene con schienale come Art. M2003 solo antiultravioletti, fissaggio diretto sulla gradinata con tasselli (non inclusi)
 Polypropylene Seat as Art. M2003 anti-ultraviolet rays, with back rest to be fixed with screws (not included)

pg.32

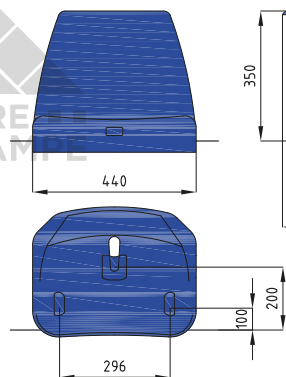

Art. M2008/M2008A

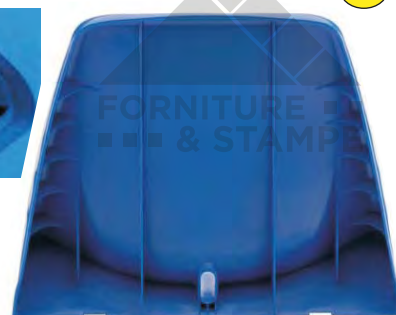

Seduta in polipropilene con schienale ignifuga e antiultravioletti **Art. M2008** oppure solo antiultravioletti **Art. M2008A** - fissaggio diretto sulla gradinata con tasselli (non inclusi)
 Polypropylene Seat non ignitable and anti-ultraviolet rays **Art. M2008** or only anti-ultraviolet rays **Art. M2008A** with back rest to be fixed with screws (not included)

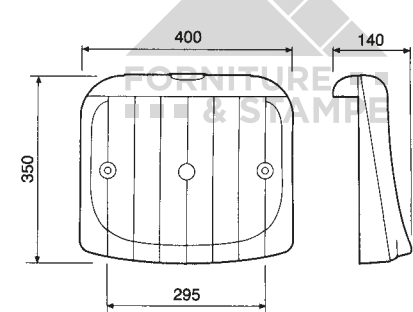

Art. M90

Seduta in polipropilene senza schienale ignifuga e antiultravioletti fissaggio diretto sulla gradinata con tasselli (non inclusi)

Polypropylene Seat non ignitable and anti-ultraviolet rays, without back rest - to be fixed with screws (not included)

Art. M90.A

Seduta in polipropilene senza schienale come Art. M90 solo antiultravioletti fissaggio diretto sulla gradinata con tasselli (non inclusi)

Polypropylene Seat as Art. M90 anti-ultraviolet rays, without back rest - to be fixed with screws (not included)

pg.32

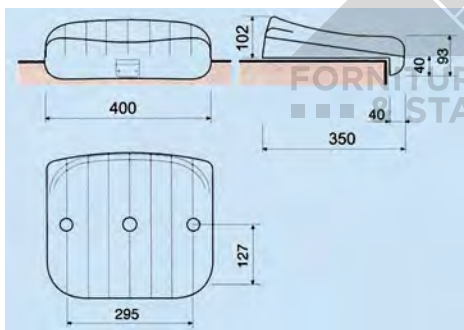

Art. M90/M90.A

TRIBUNE - Stands

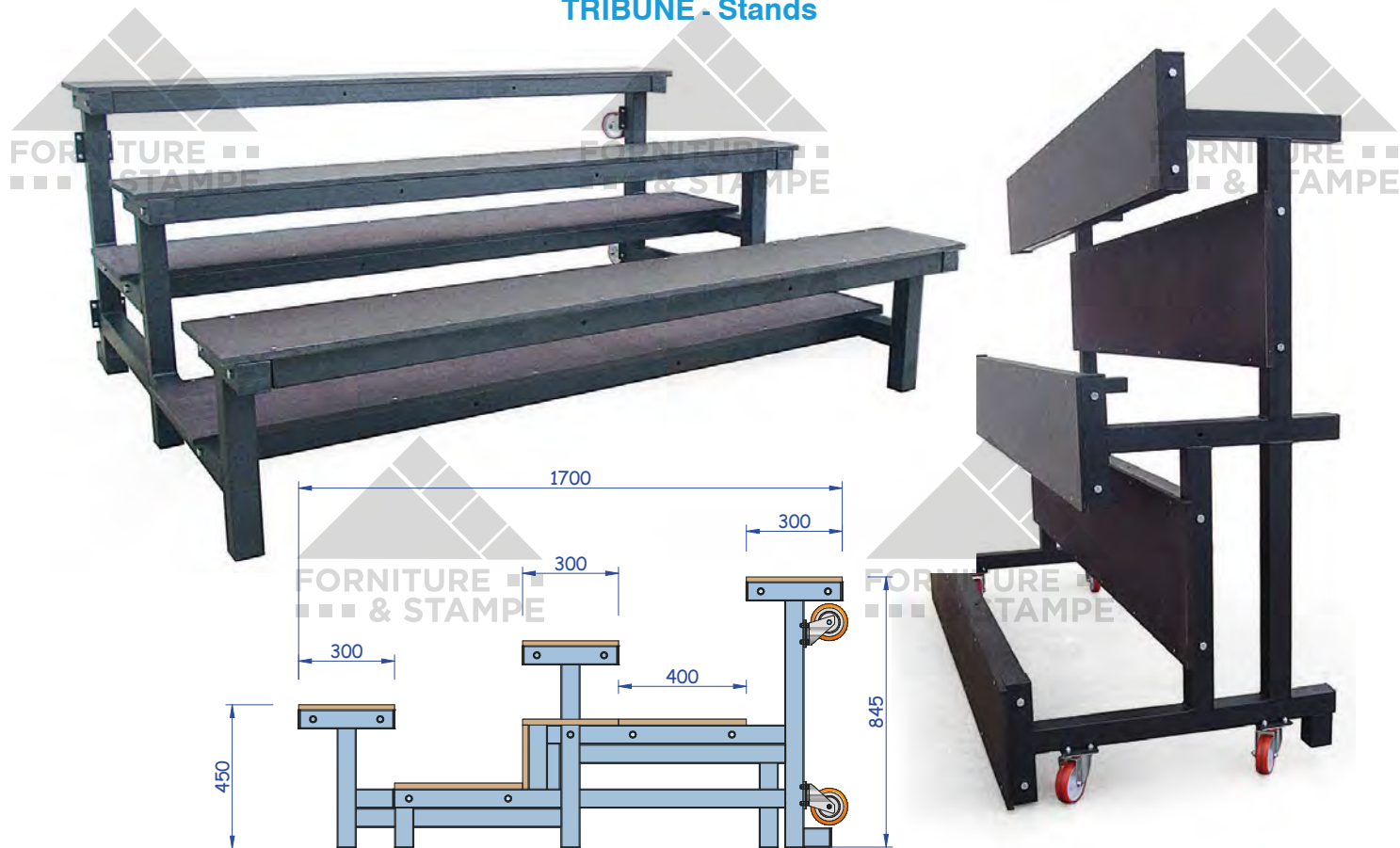

Art. G12005

Modulo Tribuna per interno/esterno su 3 file in acciaio zincato trasportabile su ruote, piani di seduta in carply, lunghezza m. 2,5

Indoor/outdoor Stand in galvanized steel, 3 rows, movable on wheels, with wooden benches

pg.33

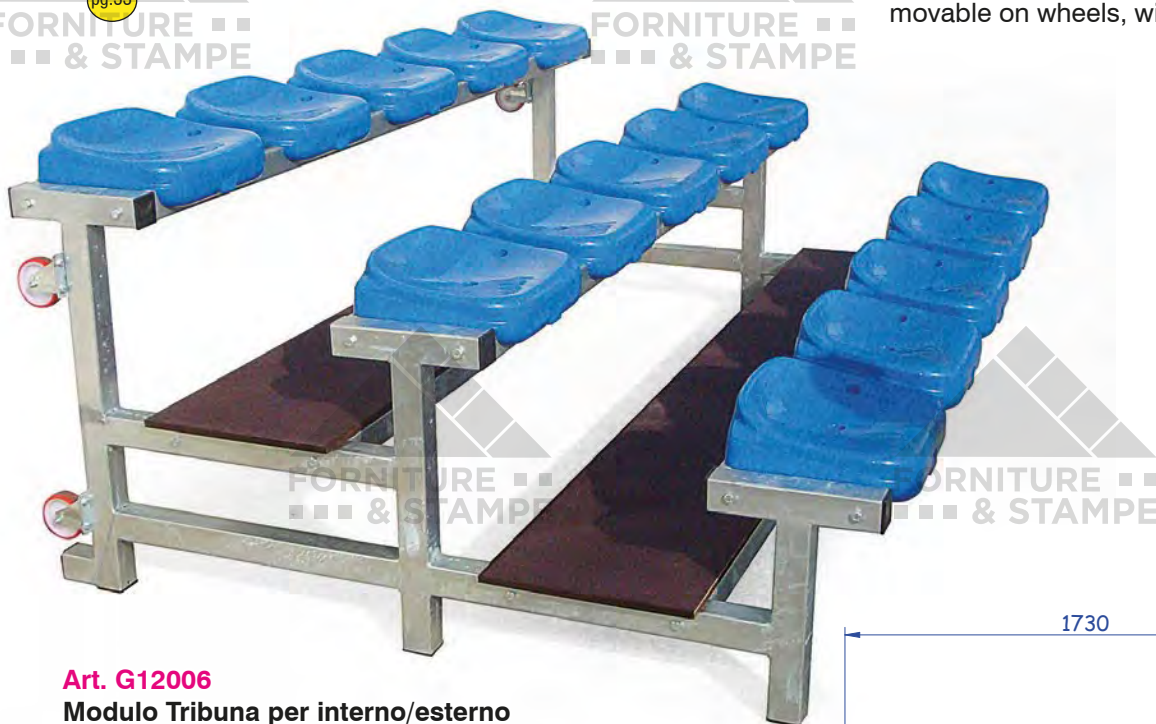

Art. G12006

Modulo Tribuna per interno/esterno su 3 file in acciaio zincato trasportabile su ruote,

piani di seduta con scocche in polipropilene, lunghezza m. 2,5

Indoor/outdoor Stand in galvanized steel, 3 rows, movable on wheels, with polypropylene seats

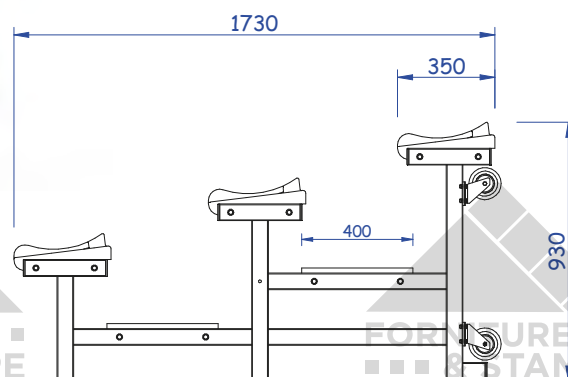



FORNITURE ■ ■ ■ & STAMPE

Art. G120TM

Tribuna telescopica da interno con sedute in polipropilene

Telescopic Stand for indoor with polypropylene seats



Art. S07700

Transenna in acciaio zincato cm. 200x100h.

Galvanized steel barrier 200x100 cm.



Art. S07710

Transenna in plastica cm. 215x90h. con piedi di appoggio a terra ruotabili, con banda catarifrangente e sistema di aggancio a catena

Plastic barrier 215x90 cm.

ARREDI PER SPOGLIATOIO - Dressing Room Benches

127,40€ **200,00€**

36,00€ **54,60€**

Art. S07326 / S07324
Tavola appendiabiti con grucce m.1 / m.2
 Clothes hanger board m.1 / m.2

Art. S07322 / S07320
Tavola appendiabiti con tettuccio lunghezza m.1 / m.2
 Clothes hanger board with bag holder m.1 / m.2

Art. S902.1E / S902.2E
Panca in acciaio verniciato con listoni in legno m.1 / m.2 con schienale e appendiabiti
 Bench in painted steel and wood length m.1 / m.2 with back rest and clothes hanger board

318,50€
445,90€

239,00€ **342,00€**

Art. S07308 / S07306
Panca in acciaio verniciato con listoni in legno m.1 / m.2 con schienale
 Bench in painted steel and wood length m.1 / m.2 with back rest

Art. S07304 / S07302
Panca in acciaio verniciato con listoni in legno m.1 / m.2
 Bench in painted steel and wood length m.1 / m.2

109,00€ **109,00€**

pg.33

91,00€ **136,50€**

Art. S07406 / S07404
Pedana poggiapiedi a listoni in legno lunghezza m.1 / m.2
 Footrest in wood length m.1 / m.2

399,00€ **570,00€**

Art. S07312 / S07310
Panca con schienale, appendiabiti e portaborse in acciaio verniciato con listoni in legno lunghezza m.1 / m.2
 Complete Bench in painted steel and wood length m.1 / m.2

Disponibile anche lunghezza m. 1,5 (al prezzo della lunghezza m. 2)
 Also available length 1,5 m. (at the same price as length 2 m.)

800,00€ **1140,00€**

Art. S07313/S07314
Panca completa ad isola per centro locale m.1 / m.2 in acciaio verniciato con listoni in legno
 Double bench in painted steel and wood length m.1 / m.2

Colore standard del telaio in acciaio: rosso. Per colore argento oppure giallo supplemento del 5% e, in caso di quantità inferiore a 10 pezzi, contributo di € 150,00 per costi di cambio colore. Altri colori su preventivo
 Standard color of the steel frame: red. For silver or yellow color 5% surcharge and, if quantity is less than 10 pieces, contribution of € 150,00 for color change costs.
 Other colors on quote



Art. V8626

Profondità seduta cm. 35
 altezza massima cm. 185
 Depth 35 cm.
 height 185 cm.

Art. V8627

581,00€

ALTRI ARTICOLI SUL LISTINO PREZZI

Art. V9093

224,00€

376,00€

985,00€

Art. V8626 / V8627
 Panca con schienale, appendiabiti e portaborse in alluminio anodizzato con inserti in PVC lunghezza m. 1 oppure lunghezza m. 2
 Complete Bench in anodized aluminium length m. 1 or length m. 2

pg.34

Art. V9092 / V9093
 Pedana poggiapiedi in alluminio anodizzato lunghezza m. 1 oppure lunghezza m. 2
 Footrest in anodized aluminium length 1 or 2 meters

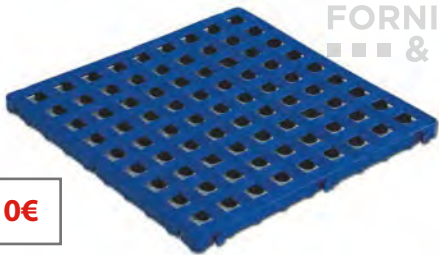

36,10€

Art. S07408
 Pedana poggiapiedi in plastica cm. 50x50
 Plastic footrest 50x50 cm.



81,70€

Art. S07434
 Graticcio per doccia in legno cm. 60x60
 Wooden footrest 60x60 cm.



386,90€

Art. S07466
 Asciugacapelli elettrico con temporizzatore e tubo flessibile
 Hair dryer with timer and flexible pipe



351,00€

Art. S07458
 Asciugamani elettrico con temporizzatore
 Hand dryer with timer



16,10€

Art. TPD Poggiapiedi Footsy idrorepellente
 Foldable foot rest waterproof



351,90€

Art. S07462
 Asciugacapelli elettrico con temporizzatore
 Hair dryer with timer

ARMADIETTI PER SPOGLIATOIO - Dressing Room Lockers



1530,00€

Art. S07226
Armadio casellario a 15 posti in lamiera verniciata - dim. vano cm. 35Lx35px35h dimensioni totali cm. 103Lx35px180h
 15 boxes sheet metal filing cabinet

pg.35

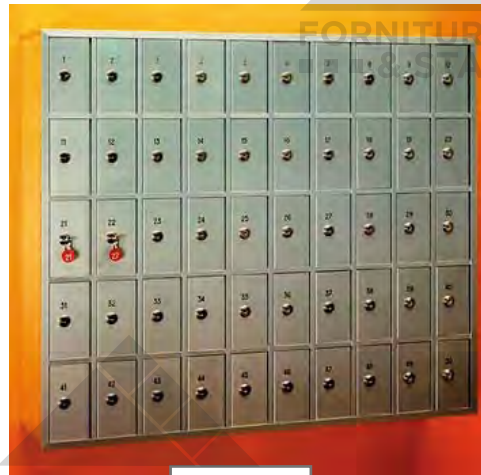

1998,00€

Art. MAP30
Armadio portavalori a 30 sportelli dim. cm. 95Lx20px50h con serrature
 Safe-deposit locker with 30 boxes

Art. MAP50
Armadio portavalori a 50 sportelli dim. cm. 95Lx20px82h con serrature
 Safe-deposit locker with 50 boxes

3295,00€

Armadietti in laminato - HPL panels



1769,00€

3009,00€

4201,00€

1675,00€

2850,00€

2776,00€

Art. S07252 / S07254 / S07256
Armadio spogliatoio in laminato dim. vano cm.30Lx50px90h
 1 colonna 2 vani
 2 colonne 4 vani
 3 colonne 6 vani
 Laminated Lockers

Art. S07258 / S07260 / S07262
Armadio spogliatoio in laminato dim. vano cm.30Lx50px180h
 1 colonna 1 vano
 2 colonne 2 vani
 3 colonne 3 vani
 Laminated Lockers

ACCESSORI PER SPOGLIATOIO ED INFERMERIA Dressing room and infirmary accessories



62,90€

Art. S07448
Specchio a parete
con cornice in plastica
diametro cm. 50
Wall mirror with frame
diameter 50 cm.

Art. S07438
Distributore di sapone
liquido a parete
Wall soap dispenser

44,00€



62,90€

Art. S07442
Distributore di salviette a parete
Wall towel dispenser

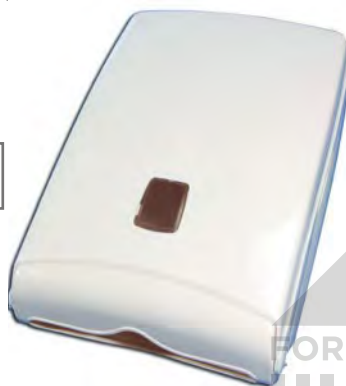

ALTRI ARTICOLI SUL
LISTINO PREZZI



282,75€

Art. S07412
Tavolo per
spogliatoio e
locale arbitri
cm. 80x80x76
Locker room
table
80x80x76 cm.

pg.34



Art. S07416 **Bacheca**
con struttura in alluminio cm. 120x90
Bulletin Board 120x90 cm.

636,00€

69,10€

Art. S07414
Sedia in acciaio cromato
scocca in polipropilene
Chromed steel chair
with polypropylene seat



144,50€

Art. S07418
Portaombrelli a 24 posti
in acciaio verniciato
Steel umbrella stand



271,00€

Art. S07715 **Spazzolone**
per pulizia e asciugatura
area pubblica e campo di gioco
Scrubber for cleaning playcourt



1082,00€

Art. S07102 / S07104
Armadio a vetri a una o due ante
Glass Cabinet with one or two doors



1319,00€



458,00€

Art. S07106 Paravento a tre ante
struttura in acciaio cromato
Three shutter foldable screen



245,00€

Art. S07138
Cassetta medica
da fissare a parete
secondo D.M. 388
First aid kit



216,00€

Art. S07136
Cassetta medica
portatile
secondo D.M. 388
First aid kit

ALTRI ARTICOLI SUL
LISTINO PREZZI

pg.34

pg.35



155,50€

Art. S07128
Scaletta scendiletto
in acciaio cromato
Bedside step



361,00€

Art. S07124
Sgabello girevole
in alluminio
Turnable stool



Art. S07108 144,50€
Appendiabiti a colonna
in acciaio cromato
Clothes stand



12,50€

Art. S07132
Cestino in plastica
Plastic trashcan



69,00€

Art. S07130
Portarifiuti
a pedale
in acciaio
verniciato
Metal trashcan



427,00€

Art. S07134
Portantina pieghevole
in acciaio cromato
Foldable Stretcher in
chromed steel

879,00€

Art. S07110
Scrivania con cassetiera
 dim. cm.130x76x78
 Desk with 3 drawers dimensions 130x76x78 cm.



128,80€

Art. S07114
Sedia imbottita in acciaio cromato Chair in chromed steel



Art. S07410
Tavolo per massaggi in acciaio imbottito in similpelle
 Massage table

819,00€



Art. PTI.BIL
Bilancia pesapersona digitale con indicazione massa grassa
 Digital scales body fat measurer

47,75€

pg.34

pg.35



719,00€

Art. 3031S
Lettino Antero chiudibile testiera regolabile
 cm.180x60x73
 peso Kg.20
 colore nero
 in acciaio cromato
 Medical couch foldable in chromed steel

154,00€

Art. 3033S
Borsone porta lettino Antero
 Bag for Art. 3031S

81,70€

Art. S07118
Portarotolo
 Paper roll holder

26,70€

Art. S07120
Rotolo carta
 Paper roll



848,00€

Art. S07116
Lettino visita medica imbottito con testiera reclinabile
 Medical couch in chromed steel, padded, adjustable headrest

TUNNEL USCITA SPOGLIATOI - Stadium tunnels

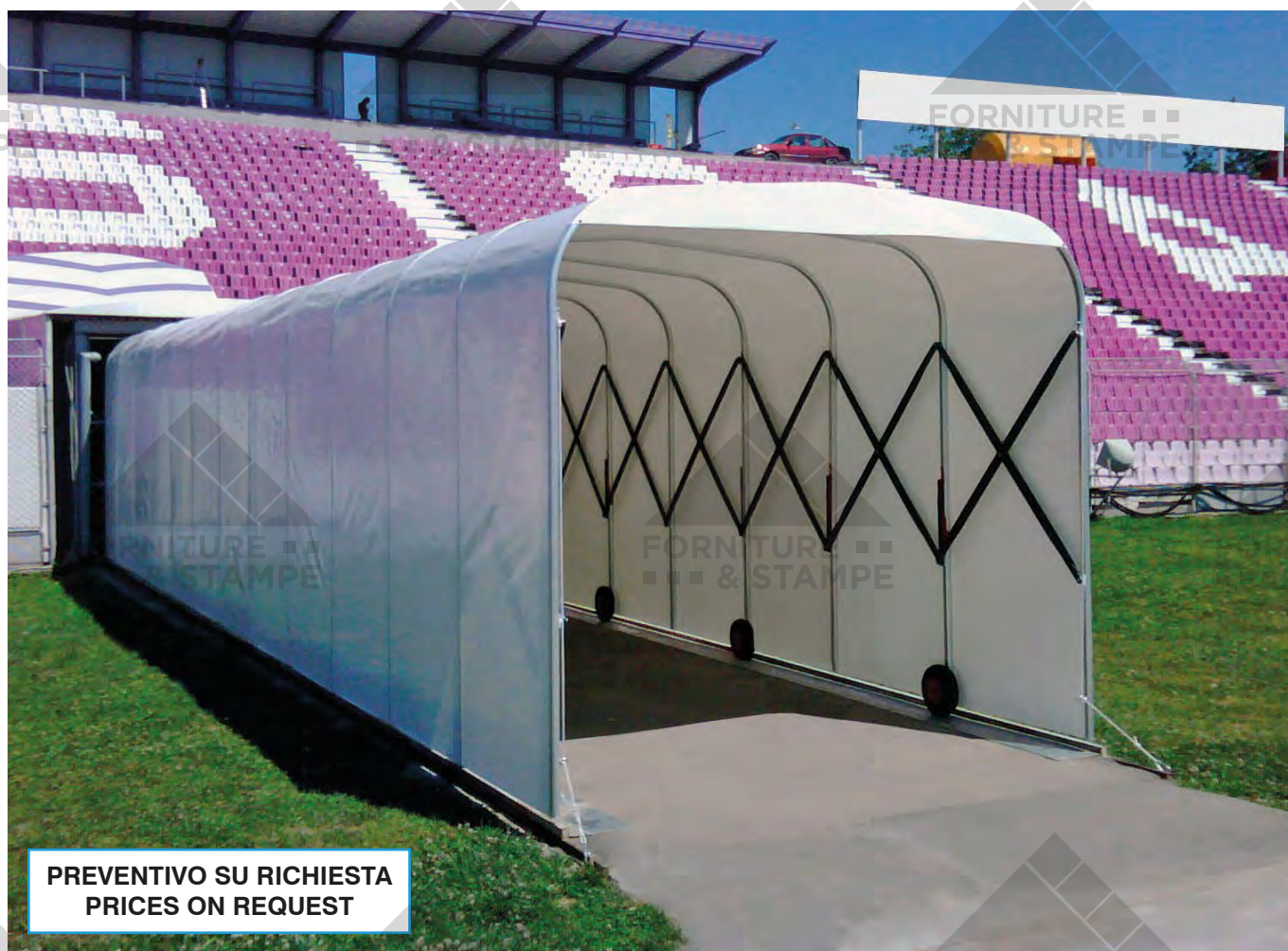

PREVENTIVO SU RICHIESTA
PRICES ON REQUEST

Art. 160 Tunnel estensibile struttura in lega d'alluminio, copertura in PVC ignifugo Cl.2 bianco o colorato, montato su ruote in nylon o pneumatiche, dimensioni standard (personalizzabili): larghezza cm.200, altezza al centro cm.232, altezza ai lati cm.200, in moduli da un metro
Extensible Tunnel in light alloy covered by fireproof PVC Cl.2, white or coloured, movable on nylon or pneumatic wheels - Standard dimensions 200 cm. width, 232 cm. height in the middle, 200 cm. height at the sides - made of one meter segments joined together



pg.32



Lunghezza, larghezza
e altezza
personalizzabili su richiesta
Any dimension available
on request



BEACH SOCCER

2280,00€

Art. PBSTR Coppia Porte Beach Soccer m. 5,5x2,2 in lega d'alluminio tubo sezione mm. 80 verniciate in giallo trasportabili
Pair of Beach Soccer goals in aluminium 5,5x2,2 m. pipe 80 mm. painted yellow transportable

2490,00€

Art. PBSFS Coppia Porte Beach Soccer m. 5,5x2,2 in lega d'alluminio tubo sezione mm. 80 verniciate in giallo con bussole a croce
Pair of Beach Soccer goals in aluminium 5,5x2,2 m. - pipe 80 mm. painted yellow with sockets

Bussola
Socket

3295,00€

Art. 110BS Coppia Porte Beach Soccer m. 5,5x2,2 in lega d'alluminio tubo sezione mm. 120x100 verniciate in giallo con estensione dei pali da insabbiare (senza bussole)
Pair of Beach Soccer goals in aluminium 5,5x2,2 m. - pipe 120x100 mm. painted yellow with extension of posts (with no sockets)



Art. 073BS Kit 10 paletti completi per Beach Soccer (6 bandierine rosse e 4 bandierine gialle)
Kit of 10 Beach Soccer Poles (6 red flags and 4 yellow flags)

132,60€



154,00€

Art. RBS Coppia reti per porte Beach Soccer m. 5,5x2,2 in polipropilene
Pair of polypropylene nets for Beach Soccer goals 5,5x2,2 m.



193,00€

Art. KDBS Kit Delimitazione per campo Beach Soccer, colore royal: 2 nastri m. 28 + 2 nastri m. 37 larghezza mm. 80 + 8 picchetti e 8 elastici
Kit for Beach Soccer bounds



23,85€

Art. ULT45 Pallone Beach Soccer Trial in gomma doppio strato (fino ad esaurimento scorte)
Trial Beach Soccer Ball double stratum rubber (until available in stock)

TAVOLI CALCETTO - Soccer tables



Art. F3FOLDY

Tavolo calcetto in acero
dim. cm.137x92x81h Kg.26
aste telescopiche e gambe ripiegabili
ideale per bambini
Soccer table for children

329,00€



809,00€

Art. JKBOM
Tavolo calcetto Bomber
senza gettoniera
aste telescopiche,
piano in vetro temperato
colore blu o bianco
Soccer table Bomber



8,10€

Art. IS432
Confezione 10 palline per
tavolo calcetto
10 Soccer table balls

pg.45



Da esterno

1285,00€

Art. G500
Tavolo calcetto da esterno
G500 Weatherproof
con aste telescopiche
Soccer table G500 for outdoor



1830,00€

Art. FTGO.G
Tavolo calcetto modello Pride
con gettoniera, aste cromate telescopiche,
gambe in ferro verniciato,
mobile in multistrato, peso Kg. 73
Soccer table model Pride with coin slot
telescopic, legs in painted steel, weight 73 Kg.

1930,00€

Art. FTEC
Tavolo calcetto modello Pride
con vetro protettivo
ad alta resistenza, peso Kg. 85
Soccer table model Pride with high resistance
safety glass, weight 85 Kg.

BASKET

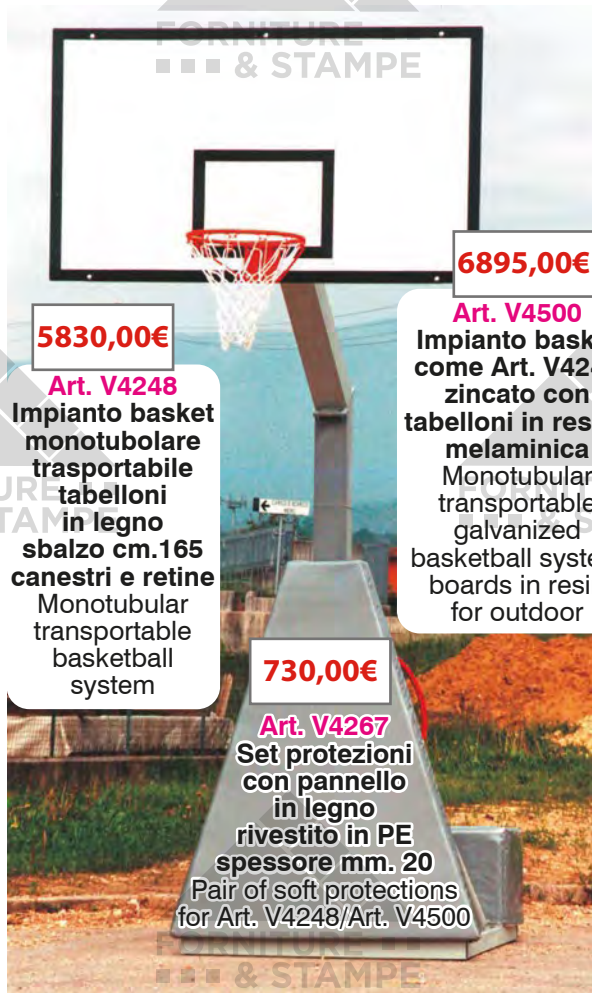

pg.35



2485,00€

2957,00€

Art. S04056 / S04058

Impianto basket a muro fisso con sbalzo cm. 185 oppure cm. 325, tabelloni in bilaminato, canestri e retine

Wall basketball system projection 185 cm. or 325 cm. wooden boards, rings and nets



351,00€

Art. S04151

Impianto minibasket a muro fisso, sbalzo cm. 80, tabelloni in bilaminato canestri e retine
Wall mini-basketball system projection 80 cm.



pg.35

pg.36

1735,00€

Art. S04152

Impianto minibasket a muro fisso, sbalzo cm. 185 tabelloni in bilaminato canestri e retine

Wall mini-basketball system projection 185 cm.



2465,00€

Art. S04150

Impianto basket/minibasket a muro regolabile in altezza tabelloni in polipropilene con canestri e retine

Wall basketball/mini-basketball system adjustable height



Art. S04161

1340,00€

Art. S04161

Coppia strutture minibasket aganciabili a tabelloni basket complete di tabelloni in bilaminato, canestri e retine (carrello per sollevamento strutture Art. S04162 non incluso)

Pair of mini-basketball constructions to be attached to basketball boards (lifting trolley Art. S04162 not included)

1592,00€

Art. S04162



194,00€

Art. 647B Minibasket a colonna regolabile in altezza da cm. 168 a cm. 229 trasportabile con canestro e retina tabellone cm. 90x60
Minibasket adjustable height from 168 cm. to 229 cm. transportable



257,00€

Art. 26759 Basket a colonna regolabile in altezza da cm. 229 a cm. 305 trasportabile con canestro e retina tabellone cm. 120x70 rinforzato
Basket adjustable height from 229 cm. to 305 cm. transportable



58,50€

Art. 26760 Tabellone minibasket in plastica da fissare al muro, fornito con canestro e retina
Wall minibasket board



3609,00€

Art. S04012 Struttura basket e minibasket richiudibile e trasportabile in acciaio verniciato, base porta zavorra, tabellone in resina, canestro fisso e retina, protezione frontale
Transportable and foldable Basket/Minibasket in painted steel, resin board, front protection

pg.35

pg.36



830,00€

Art. F126BSK Set Baskin trasportabile altezza regolabile fino a cm. 220 tabellone cm. 110x73 base zavorrabile su ruote
Transportable Baskin adjustable height until 220 cm.



36,60€

Art. F102

Canestro Basket regolamentare
(retina esclusa)
Basket standard



58,50€

Art. F103

Canestro Basket rinforzato
(retina esclusa)
Basket reinforced



79,70€

Art. F105

Canestro Basket zincato
(retina esclusa)
Basket galvanized



10,00€

Art. B030

Coppia Retine in nylon
mm. 3,5
Pair of nets 3,5 mm.



16,10€

Art. B050

Coppia Retine in nylon
mm. 6
Pair of nets 6 mm.



27,10€

Art. B060

Coppia Retine in
cotone mm. 7
Pair of nets 7 mm.



41,50€

Art. R122

Coppia Retine in acciaio
Pair of steel nets



380,00€

Art. F106

Canestro Basket reclinabile, a norme FIBA
(retina esclusa)
Reclining Basket

pg.36

14,60€

Art. NRG

Set 12 ganci reggirete in
plastica per canestro basket
Set 12 plastic basket net holders

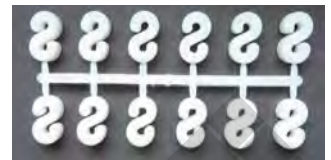

449,00€

364,00€

819,00€

990,00€

546,00€

Art. S04202 - S04214 - S04204 - F116/B - S04216

Coppia tabelloni in bilaminato per interno oppure in
resina melaminica per esterno - varie dimensioni
Pair of basketball boards in chipboard for indoor
or in resin for outdoor - various sizes



Brevettato
Patented

692,00€

Art. F109
Canestro Basket
reclinabile
frontalmente
e lateralmente
(retina esclusa)
Front/Side
reclining Basket

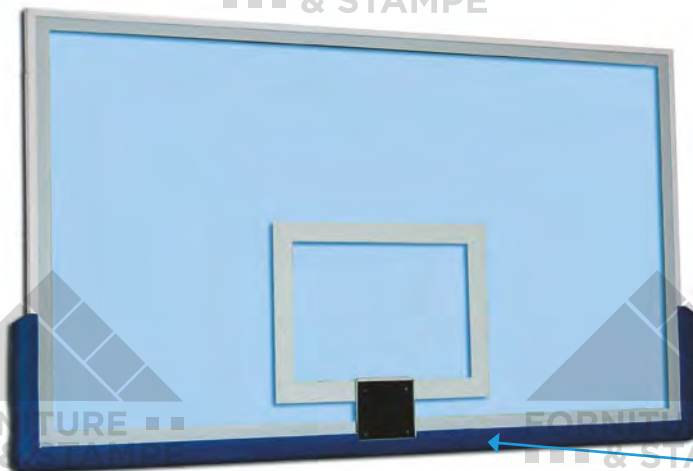

4075,00€

2875,00€

Art. S04206 / S04208

Coppia tabelloni in Plexiglass trasparente
oppure in cristallo temperato dimensioni
cm. 180x105 - compreso telaio e protezione
Pair of basketball boards in trasparent acrylic
or tempered glass 180x105 cm.
mounted onto varnished steel frame with pads

Art. B2063B / B2063

Coppia Protezioni sottocanestro omologate FIBA e non
Pair of soft board protection pads FIBA approved or not



867,00€

Art. S04254
Panca per atleti e riserve con schienale m.3
 Bench length 3 meter with back rest

Art. S04266 591,00€

Protezione mobile per tavolo giuria e atleti in policarbonato trasparente
 Transparent movable polycarbonate protection for benches and referees' table



544,00€

Art. S04256
Tavolo giuria
 cm. 160x80x76h.
 Referee table

pg.36



1819,00€

Art. S04260
Tavolo per giuria cm. 300x70x76h.
 in acciaio verniciato e carenatura in legno, mobile su ruote
 Referee table on wheels



Art. S04288
Freccia indicatrice possesso palla
 Ball possession arrow

125,50€



485,00€

Art. F255
Freccia indicatrice elettronica possesso palla
 Electronic ball possession indicator



373,00€

Art. F254
Segnalatore time out con impugnatura
 Time out indicator



257,40€

Art. CR016
Cronometro contasecondi da tavolo a pila con display digitale
 Digital Table Clock for basketball



275,00€

Art. CR005
Cronometro contasecondi da tavolo a pila con lancette
 Table Clock for basketball



Art. S04280
Segnapunti
manuale
girevole
a 6 cifre
6 figure
Scoreboard

1228,00€



Art. S04274
Serie Palette 24"
Set of 24 sec indicators

201,00€



Art. B01084
Segnapunti da tavolo per Basket
Table scoreboard

52,50€



Art. S04272
Serie palette per giudici
Set of referee's foul indicators

251,00€



Art. S04282
Segnapunti manuale a parete a 6 cifre,
struttura in acciaio verniciato
Wall steel 6 figure scoreboard

1046,00€

pg.36 pg.37

13,50€

Art. 089-B
Lavagna Basket
cancellabile cm. 40x23
Basket Tactical Board
erasable 40x23 cm.

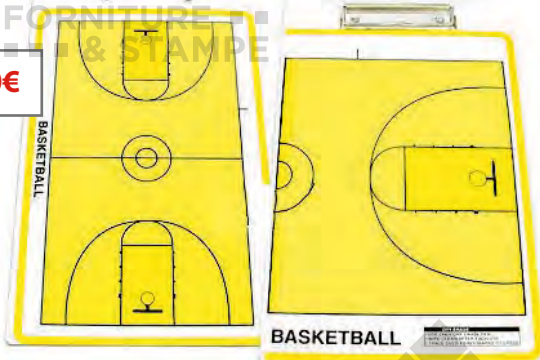

97,50€

Art. 087-B
Lavagna
Basket
magnetica
cancellabile
cm. 60x85
Basket Tactical
Board erasable
and magnetic
60x85 cm.



21,25€

Art. LSRK
Lavagna Basket magnetica cm. 40x23
con block-notes (fino ad esaurimento)
Basket Tactical Board
magnetic 40x23 cm. with block-notes
(until available)



SKLZ



14,80€

Art. SK.CVS

COURT VISION

Occhiali a visibilità limitata per allenamento al palleggio a testa alta, alla visione di gioco e alla reattività nei confronti dei difensori
misura unica regolabile
Court vision dribble goggles force players to handle the ball with their head up to survey the court improve reaction time against defenders increase confidence on the court

SKLZ



82,00€

Art. SK.KOT

KICK-OUT per ritorno palla dopo tiro a canestro, direzione regolabile
360° ball return system
rotating chute returns made shots anywhere on the court
easy twist adjustment with integrated handle



La fascia con le braccia gonfiate deve essere posizionata all'altezza delle spalle e, per installarla, può essere necessario sgonfiare moderatamente la sagoma. Successivamente, dopo avere rigonfiato, se la sagoma torna in posizione verticale con difficoltà si deve aggiungere dell'acqua nel serbatoio

pg.37

147,20€

Art. KBVS

Kit braccia verticali per sagoma gonfiabile cm. 205 Art. SAG205
Raised arms kit for inflatable dummy 205 cm. Art. SAG205

Specifico per il Basket, il kit si installa facilmente sulla sagoma (non inclusa) e rende possibile una moltitudine di esercizi tecnico-tattici
Designed for Basket training, this kit is easily installed on the dummy (not included) and makes lots of technical and tactical exercises possible

SKLZ



141,60€

Art. SK.DMAN

Sagoma Basket D-MAN ad altezza regolabile da cm. 198 a cm. 243 con basamento riempibile,

munita di puntali per fissaggio anche su terreni naturali
Hands-up defensive mannequin ideal for solo practice or team settings portable, lightweight adjustable telescoping pole (from 198 cm. to 243 cm.) Weighted base - including spikes for natural grass anchoring



Art. SB4Y Pallone avviamento al Minibasket Molten gomma nylon misura 4 Minibasket introduction ball



Art. BHAR5 / BHAR7 Pallone Basket e Minibasket gomma nylon misure 5 (blu) - 7 (arancio) Nylon rubber Basket and Minibasket ball

pg.37



Art. SBPRO5 Pallone Minibasket Mondo SB-PRO size 5 gomma multistrato Multilayer rubber Minibasket Mondo SB-PRO size 5 ball



Art. B5G1600 Pallone Minibasket Molten B5G1600 gomma nylon (ex BGR5) Nylon rubber Minibasket Molten B5G1600 ball



Art. SBPRO7 Pallone Basket Mondo SB-PRO size 7 gomma multistrato Multilayer rubber Basket Mondo SB-PRO size 7 ball



Art. B7G1600/B6G1600 Pallone Basket Molten B7G1600/B6G1600 gomma nylon (ex BGR7/BGR6) Nylon rubber Basket Molten B7G1600/B6G1600 ball



Art. B7G3800/B6G3800 Pallone Basket Molten B7G3800/B6G3800 pelle sintetica FIBA Approved (ex BGM7X/BGM6X) Leather Basket Molten B7G3800/B6G3800 ball

Art. B7G4000/BGF6X Pallone Basket Molten B7G4000/BGF6X pelle sintetica ufficiale FIP Leather Basket Molten B7G4000/BGF6X ball



Art. B7G4500/B6G4500 Pallone Basket Molten B7G4500/B6G4500 pelle sintetica ufficiale FIP Lega Serie A (ex BGG7X/BGG6X) Leather Basket Molten B7G4500/B6G4500 ball



Art. TRBB Pallone reaction ball Trial rimbalzo e traiettorie imprevedibili per Basket Trial Reaction Ball unpredictable rebounds



Art. ULTES60 Pallone Basket sonoro Goalball gomma Trial Ø cm. 24 gr. 1240 Sound rubber Trial Basket ball Goalball



Art. ULTS67 Pallone Basket gomma Trial allenamento potenziato Ø cm. 24 gr. 930 (+50%) Rubber Trial Heavier Basket ball



Art. ULTD67 Pallone Basket gomma Trial allenamento potenziato Ø cm. 24 gr. 1240 (+100%) Rubber Trial Heavier Basket ball



Art. 6746T

536,00€

PALLAVOLO - Volleyball

Art. 6746T
 Impianto pallavolo monotubolare in acciaio zincato Ø mm. 76 completo di bussole da interrare cm. 40 e tendirete, altezza della rete regolabile
 Volleyball posts in galvanized steel with underground sockets adjustable height net

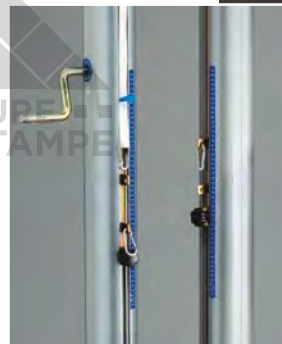

Art. V5009



Art. V5009
1420,00€

Impianto pallavolo monotubolare in alluminio T6 antiflessione mm. 120x100 con arganello tendirete autofrenante e senza cremagliera con manovella asportabile bussole e tappi in alluminio
 Aluminium monotubular volleyball posts

pg.38

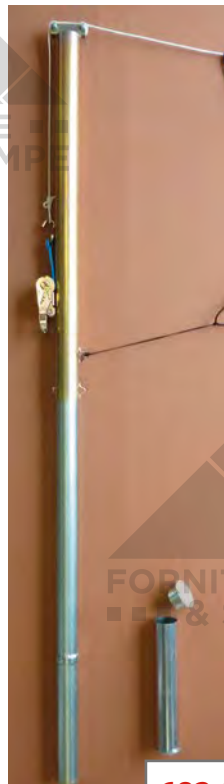

Art. V5003
682,00€

Impianto pallavolo monotubolare in acciaio zincato Ø mm. 70 completo di bussole da interrare e tendirete, con sistema telescopico per la regolazione della rete con doppia carrucola sulla sommità del palo
 Volleyball posts in galvanized steel with underground sockets telescopic posts adjustable height net

Art. 6747/P
2310,00€

Impianto pallavolo monotubolare a norme FIPAV in alluminio sezione mm. 120x100 regolazione dell'altezza dei pali e della rete con sistema periscopico con arganello tendirete e bussole incluse
 Aluminium monotubular volleyball posts periscopic system FIPAV approved

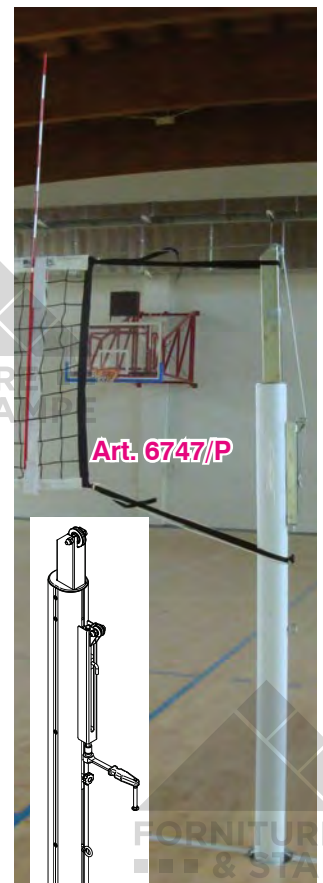

Art. 6747/P



Art. ARG
219,00€

Arganello a cremagliera con manovella per impianto pallavolo monotubolare
 Spare rack winch for monotubular volleyball posts

Lato interno
 Inner side

Art. MB2083
310,00€

Coppia Protezioni in gommapiuma rivestita per impianto monotubolare
 Pair of soft protections for volleyball posts

IMPIANTO = coppia pali (rete esclusa)

La regolazione periscopica permette di variare l'altezza dei pali insieme a quella della rete (che può essere regolata da cm. 215 a cm. 243)

● I numeri in giallo indicano la pagina di riferimento del Listino Prezzi 20

453,50€

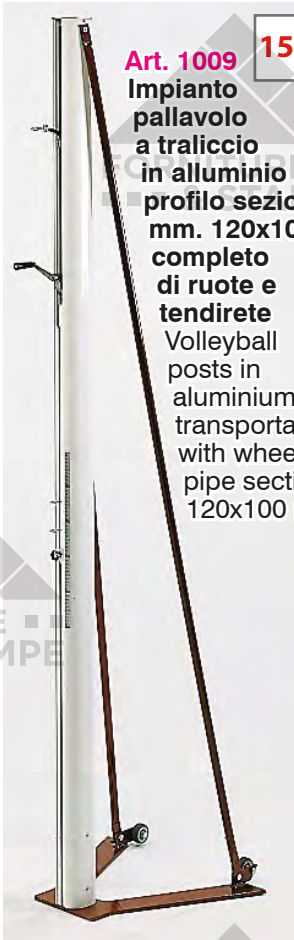

Art. 1009
1500,00€
 Impianto pallavolo a traliccio in alluminio profilo sezione mm. 120x100 completo di ruote e tendirete
 Volleyball posts in aluminium transportable with wheels, pipe section 120x100 mm.

Art. MB2236
453,50€
 Coppia protezioni in gommapiuma rivestita per impianto a traliccio
 Pair of soft protections for volleyball posts



Lato interno
 Inner side

1100,00€

Art. 6740R
1100,00€
 Impianto pallavolo a traliccio ø mm. 70 in acciaio verniciato completo di tendirete e ruote
 Volleyball posts in painted steel with wheels pipe section 70 mm.

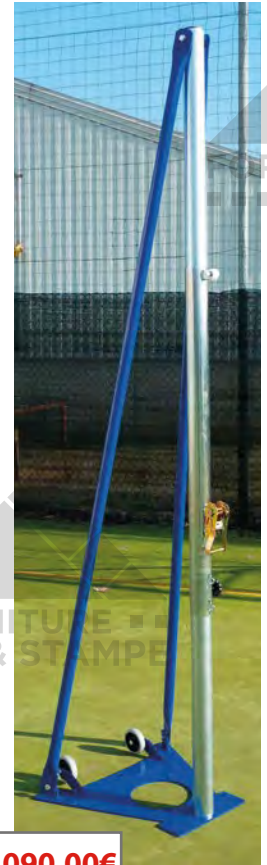

1090,00€

Art. V5020
1090,00€
 Impianto pallavolo a traliccio ø mm. 70 in acciaio zincato completo di ruote e tendirete
 Volleyball posts in galvanized steel, transportable with wheels pipe section 70 mm.



Art. 6752/T
470,00€
 Impianto Pallavolo a parete
 Volleyball posts for wall fixing



Art. 6752/P
470,00€
 Coppia protezioni per impianto Pallavolo a parete
 Pair of soft protections for volleyball posts for wall fixing

pg.38

pg.39

IMPIANTO = coppia pali (rete esclusa)

2320,00€

Art. V5029
2320,00€
 Impianto pallavolo a tiranti ridotti in lega di alluminio profilo sezione mm. 120x100 con ruote per il trasporto piastra antitorsione alla base, arganello tendirete autofrenante senza cremagliera antinfortunistico
 Volleyball posts in aluminium transportable with wheels, pipe section 120x100 mm.



● Numbers in yellow show the relevant page on 2024-2025 Price List



Art. E6532

Rete pallavolo economica m. 9,85
Cheap net for volleyball

45,00€

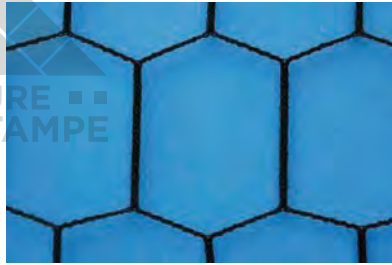

Art. P030

Rete pallavolo m. 9,50
Net for volleyball

79,75€

pg.39



Art. P100

Rete pallavolo super pesante m. 9,50
maglia mm. 100
Heavy net for volleyball

105,90€



Art. P110

Rete pallavolo extra pesante
m. 9,50 maglia mm. 100
a doppia fascia
Heavy net for volleyball double band

150,00€



Art. P200

Rete pallavolo da gara
maglia mm. 100
con antenne e tasche
a norma FIPAV
Official net for volleyball
with sticks and fixing bands

221,00€



Art. P201

Rete pallavolo da gara
maglia mm. 45
a norma FIPAV
per campionati di Superlega
(personalizzabile)
Official net for volleyball
(customizable)

204,50€

41,90€

Art. P14

Coppia antenne in vetroresina divise
Fiberglass sticks in 2 pieces

Art. P15 Coppia
tasche porta
antenne cm. 5
Fixing bands for
sticks

15,15€

Art. P16

Coppia antenne in
vetroresina intere
One piece fiberglass
sticks

48,25€



Art. S04814
Segnapunti
manuale
girevole
a 4 cifre
4 figure
scoreboard

955,00€



Art. PP054

Segnapunti manuale
da tavolo per Pallavolo bifacciale
(numeri da 0 a 50 non divisi)
Volleyball table scoreboard

63,40€



Art. PPP30

Segnapunti scolastico per Pallavolo
(numeri da 0 a 30 non divisi)
Volleyball school scoreboard

59,50€



1322,00€ Art. S04804
Palchetto arbitro pallavolo ad altezza fissa con scocca di seduta, in acciaio verniciato, mobile su ruote
 Referee's stand fixed height with plastic seat, made of painted steel, on wheels

Art. 6768R **719,50€**
Palchetto arbitro pallavolo in piedi, in acciaio verniciato, mobile su ruote
 Referee's stand made of painted steel, on wheels



New!



Art. S04805 **910,00€**
Set protezioni imbottite per palchetto Art. S04804
 Soft protections for Art. S04804

pg.39



1815,00€

Art. V5409
Palchetto arbitro pallavolo a norma FIPAV regolabile in altezza con scala di accesso e ruote per trasporto
 FIPAV Referee's chair



682,50€

Art. S04816
Serie 18 Palette per sostituzione giocatori con contenitore
 Set of 18 substitution indicators



New!

Art. V5419 **690,00€**
Set protezioni imbottite per palchetto Art. V5409
 Soft protections for Art. V5409



Art. 089-V **13,50€**
Lavagna per pallavolo cancellabile cm. 35x25
 Volleyball Tactical Board erasable 35x25 cm.



Art. V5081
Simulatore di muro su ruote in acciaio, zavorrato, con pannello a superficie irregolare
 Portable wall in painted steel with irregular surface board

1949,00€

pg.39



575,00€

Art. V5082
Simulatore di muro portatile per squadre femminili e giovanili
 Portable wall for women and kids



610,00€

Art. V5070
Ball Catcher cm. 70x70 altezza regolabile da cm. 190 a cm. 320 con anello superiore inclinabile, basamento zavorrato e retone inclusi
 Ball Catcher adjustable height and inclination (weighted base and net included)

672,00€

Art. V5051
Jump Tester in acciaio zincato telescopico regolabile da cm. 230 a cm. 380 (basamento zavorrato non incluso)
 Jump Tester in galvanized steel telescopic adjustable height from 230 to 380 cm. (weighted base not included)



379,00€

Art. V5060 Spike con ganasce (basamento zavorrato non incluso)
 Spike with jaws (weighted base not included)

343,00€

Art. V5050
Basamento zavorrato multiuso per Ball Catcher, Spike, Jump Tester
 Multi-purpose weighted base



● I numeri in giallo indicano la pagina di riferimento del Listino Prezzi 2024-2025



Utilizzabile anche per Hit Ball

Art. BV20
Pallone Volley Trial in gomma supersoft
Supersoft Trial Volley ball (also for Hit Ball)

pg.39 pg.40



Art. V20
Pallone Volley Trial in gomma monostrato
Single stratum Trial Volley ball



Art. ULT20-3
Pallone Volley Trial in gomma triplo strato
Triple stratum Trial Volley ball

Art. MVBS
Pallone Volley School Mondo Under 13 peso ridotto
Under 13 Mondo Volley School ball

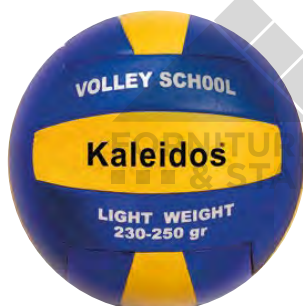

Art. 18335
Pallone Volley School Molten V5M2501-L Under 13 peso ridotto
Under 13 Molten Volley School ball



New!



Art. VS123WL
Pallone Volley School Mikasa VS123W-L
Under 13 Mikasa Volley School ball

Art. VS123W
Pallone Volley Mikasa VS123W allenamento
Mikasa Volley training ball



Art. V300W
Pallone Volley Mikasa V300W FIVB approved
Mikasa Volley match ball



Art. BT51004
Pallone Volley regolamentare in PU allenamento
Official size and weight Volley training ball



Art. E6835
Pallone Volley Soft Touch in PU saldato, regolamentare allenamento
Official size and weight Volley training ball



Art. 29096
Pallone Volley Molten Ultra Touch V5M1500 allenamento
Molten Volley training ball



Art. 6036
Pallone Volley Molten V5M4000 allenamento professionale
Pro Molten Volley training ball



Art. 6331
Pallone Volley gara Molten V5M5000 "FLISTATEC" FIVB Approved
Molten Volley match ball



Art. TRBV
Pallone Reaction Ball Trial doppio strato per Volley rimbalzo e traiettorie imprevedibili
Trial Volley ball for unpredictable rebounds

I numeri in giallo indicano la pagina di riferimento del Listino Prezzi 2024-2025



Art. USE20
Pallone Volley Trial
 gr. 405 (+50%) ø cm. 21
 allenamento potenziato
 Rubber Trial heavy Volley ball



Art. ULTD20
Pallone Volley Trial
 gr. 540 (+100%) ø cm. 21
 allenamento potenziato
 Rubber Trial heavy Volley ball

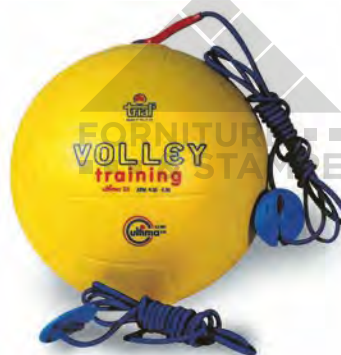

Art. ULT22
Pallone Volley Trial con 2 elastici
 Trial Volley ball with 2 elastic ropes

pg.40 pg.41



Art. P135
Rete MINIVOLLEY su misura a richiesta
 Net for minivolley size on request

Art. P135A
Rete MINIVOLLEY con cavo in acciaio su misura a richiesta
 Net for minivolley with steel rope size on request

Art. P130
Rete MINIVOLLEY cm.500x70
 Net for minivolley

Art. P140
Rete SUPERMINIVOLLEY cm.650x100
 Net for superminivolley

MINIVOLLEY SUPERMINIVOLLEY

Art. 6780G
Impianto Minivolley trasportabile su ruote
 altezza massima rete cm.200
 Transportable Minivolley posts adjustable height net (200 cm. maximum height)



Art. BV15
Pallone PRIMO VOLLEY Trial in gomma supersoft
 Trial supersoft Volley ball



Art. 191S
Pallone MINIVOLLEY Mondo in gomma
 Mondo rubber Minivolley ball



Art. V33
Pallone MINIVOLLEY Trial in gomma
 Trial rubber Minivolley ball



Art. 6332
Pallone MINIVOLLEY Molten in gomma
 Molten rubber Minivolley ball



Art. ULT15-3
Pallone PRIMO VOLLEY Trial in gomma triplo strato
 Trial triple stratum Volley ball



Art. 991725/ ... /991728
Kit elastici allenamento pallavolo soft/medium/hard/extra hard
 Elastics for volleyball training soft/medium/hard/extra hard



Art. ULT26-3 / ULT27-3
Pallone MINIVOLLEY/ SUPERMINIVOLLEY Trial in gomma triplo strato
 Trial triple stratum Minivolley/ Superminivolley ball



Art. V27
Pallone SUPERMINIVOLLEY Trial in gomma
 Trial rubber Superminivolley ball

BEACH VOLLEY

987,00€

Art. 1051 Impianto Beach Volley regolamentare in alluminio Ø mm. 80 (rete esclusa) altezza rete regolabile anche per Beach Tennis
Beach volley posts in aluminium (net not included) adjustable height net also for Beach Tennis

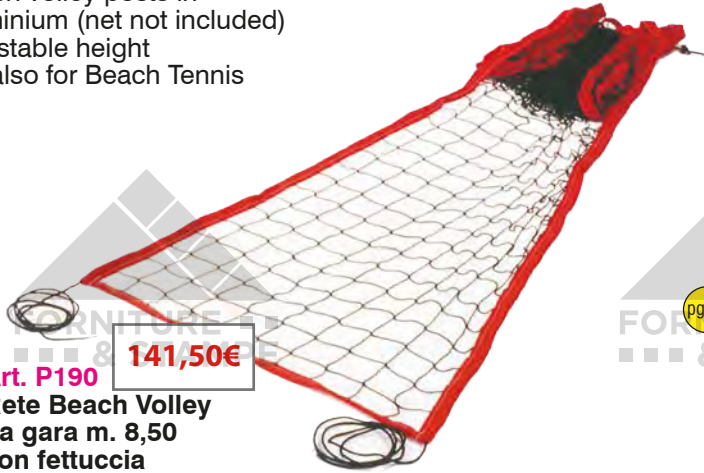

141,50€

Art. P190 Rete Beach Volley da gara m. 8,50 con fettuccia sull'intero perimetro
Beach volley match net

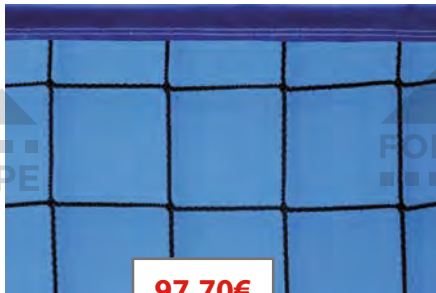

97,70€

Art. P170 Rete Beach Volley m. 8,50 con fettuccia sul lato superiore
Beach volley net



Lato A Lato B

251,30€

Art. BVMBP Coppia protezioni per impianto Beach Volley regolamentare altezza cm. 200 diametro cm. 8
Pair of soft protections for Beach Volley posts



148,00€

Art. F501 Impianto Mini Beach Volley portatile con pali telescopici in ferro verniciato completo di rete m. 6,5x1 e sacca
Mini Beach Volley complete set



Art. F501

IMPIANTO = coppia pali (rete esclusa)

626,00€

Art. V5513 Impianto Beach Volley in alluminio Ø mm. 80 (rete esclusa) senza bussole altezza rete regolabile anche per Beach Tennis
Beach Volley posts in aluminium (net not included) with no sockets adjustable height net also for Beach Tennis

801,00€

Art. V5510 Impianto Beach Volley in acciaio zincato Ø mm. 70 (rete esclusa) altezza rete regolabile anche per Beach Tennis
Beach Volley posts in galvanized steel (net not included) adjustable height net also for Beach Tennis





Art. V5543

Seggiolone per arbitro Beach Volley in acciaio ovale verniciato a polveri sez. mm.60 antinfortunistico e richiudibile in soli cm.45
Beach Volley referee's Stand

Art. V5428

Protezioni imbottite per seggiolone Art. V5543
Soft protections for Art. V5543



pg.41

Art. P17

Kit Delimitazione campo Beach Volley
2 nastri m.16 + 2 nastri m. 8 + 8 picchetti + 8 elastici
nastri larghezza mm. 50 con occhielli alle estremità
Set for Beach Volley Bounds



Art. P19 Kit Delimitazione regolabile per campo Beach Volley e Beach Tennis - 2 nastri m.16 + 2 nastri m.8 oppure 2 nastri m.18 + 2 nastri m.9 colore royal
Set for Beach Volley and Beach Tennis adjustable bounds color royal



Art. M13719

Pallone Beach Volley Mondo BV 2000 in pelle sintetica
Mondo Beach Volley ball



Art. 6340

Pallone Beach Volley Molten V5B5000 da gara ufficiale FIVB
Molten Beach Volley match ball



Art. 29097

Pallone Beach Volley Molten "Sweet Touch"
Molten Beach Volley ball



PROTEZIONI - Protections



Art. E6644

Paio ginocchiere Volley trapuntate misura S, M, L colori royal, navy, nero, rosso, fucsia, giallo fluo, verde fluo
Pair of knee protections size S, M, L

pg.40



Art. E6645

Paio ginocchiere Volley senza foro posteriore con imbottitura modellata misura JR e SR, colore royal
Pair of knee protections for match size JR and SR



Art. 9293

Paradenti singolo taglia adulto
Adult Mouthguard

Art. 9293.B

Paradenti singolo taglia bambino
Junior Mouthguard

Disponibili anche senza reggi-paradenti



Art. 43602A

Paradenti doppio taglia S-L
Double Mouthguard Size S-L



Art. E6641

Paio ginocchiere Volley professionali regolabili con velcro, misura SR colori blu e nero
Pair of pro knee protections size SR adjustable with velcro - colors blue and black



Art. PDFOX

Paradenti FOX singolo taglia adulto - vari colori
Adult FOX mouthguard - various colors



Art. E6642

Paio ginocchiere Volley gara misura JR e SR colori royal, rosso, bianco e nero (fino ad esaurimento scorte)
Pair of knee protections for match size JR and SR (until available)



pg.40



Art. ESPN

Maschera di protezione per naso, zigomi e arcata sopracciliare
Face Protection Mask



Art. E6633

Paio gomitiere Volley, misura JR e SR colori royal, rosso e nero
Pair of elbow protections size JR and SR



Art. E6649

7,30€

Art. E6650

7,30€

Art. E6670

7,30€

Art. E6649

Paio ginocchiere elasticizzate misura S-M-L-XL
Pair of elastic Knee Protections size S-M-L-XL

Art. E6650

Paio cosciere elasticizzate misura S-M-L-XL
Pair of elastic Thigh Protections size S-M-L-XL

Art. E6670

Paio cavigliere elasticizzate misura S-M-L-XL
Pair of elastic Ankle Protections size S-M-L-XL

32,65€

Art. IS799

Ginocchiera con supporti rigidi
taglia S/M - L/XL
Knee protection with metal support

9,75€

Art. E784

Ginocchiera in neoprene traspirante con foro
taglia S-M-L
Neoprene Knee Protection



Art. E790

Cavigliera in neoprene
taglia S-M-L
Neoprene Ankle Protection

9,00€

New!



13,50€

Art. ACISM

Arm compress colore nero
misura S cm.37 - M cm.40 - L cm.43
Arm compress black color



pg.40

4,90€

Art. AHF-075
Polsiera stabilizzante in neoprene con foro per il pollice e chiusura regolabile con velcro
Stabilizing neoprene cuff with thumb hole and adjustable velcro closure



11,30€

Art. E798

Supporto Coscia in neoprene
taglia S
(ad esaurimento)
Neoprene Thigh Protection (until available)



8,50€

Art. 90252A

Fascia sottorotulea in neoprene
Neoprene underknee band



Art. 2651A

35,15€

Short in neoprene vita alta colore nero
taglia S-M-L-XL
Neoprene Shorts



13,50€

Art. 73001

Sospensorio con conchiglia
misura S, M, L
Shell Protection size S, M, L



10,10€

Art. AHF-079

Pancierina in neoprene
taglia unica cm. 120x25x0,4
Neoprene stomach band 25 cm. height

IMPIANTI MULTIFUNZIONE Multi-purpose systems

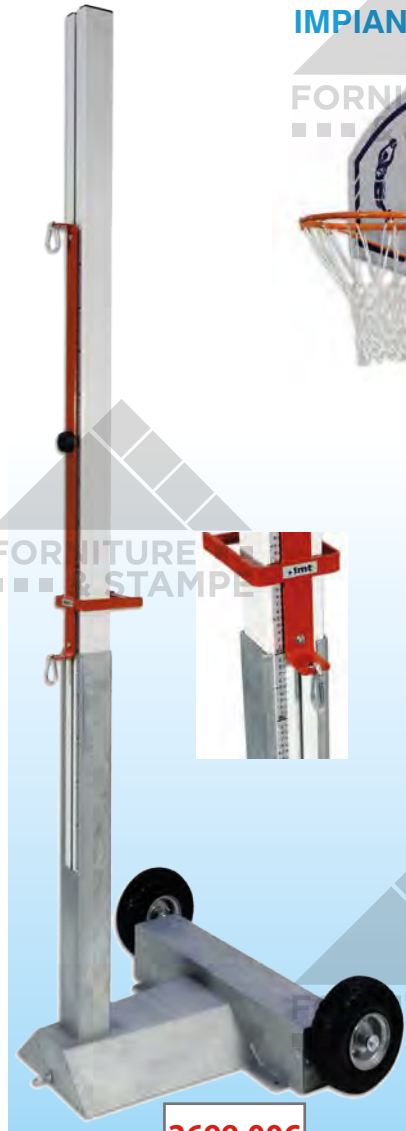

Art. S05206 2699,00€

Impianto multifunzione professionale per volley, minivolley, tennis e salto in alto - basi zavorrate in acciaio zincato su ruote gommata, ritti centimetrati in alluminio verniciato con cursore scorrevole
Volley, Minivolley, Tennis and High Jump transportable system - galvanized weighted bases with wheels, posts in painted aluminium with slider



Art. S05208 767,00€
Coppia tabelloni basket/minibasket in plastica con canestri su supporto in acciaio per Art. S05206
Pair of boards with baskets and steel back frames for Art. S05206

767,00€

1635,00€

Art. 6780M
Impianto volley e minivolley trasportabile zavorrato
Weighted Volley and Minivolley transportable system



66,00€

Art. S05210
Rete per impianti multifunzione
Art. S05206/130FA/6780M
dimensioni m. 9x1
Net for multi-purpose systems size m. 9x1



pg.43

1735,00€

Art. S05209
Set protezioni per impianto multifunzione
Art. S05206
Soft Protection set for transportable system Art. S05206

IMPIANTO = coppia pali (rete esclusa)



275,00€

Art. 130FA
Impianto multifunzione volley, minivolley, badminton, tennis trasportabile zavorrato con strutture verticali in acciaio verniciato metallizzato Ø mm. 80, basi in plastica riempibili da litri 105 con ruote
Volley, minivolley, badminton, tennis transportable system with painted steel poles Ø 80 mm. 105 liter refillable plastic bases with wheels



419,00€

Art. KB130
Coppia tabelloni basket/minibasket con canestri da applicare ad impianto multifunzione
Art. 130FA
Pair of boards with baskets for transportable system Art. 130FA

214,00€

Art. 131F
Set protezioni imbottite sagomate per impianto multifunzione Art. 130FA
Soft protection set for transportable system Art. 130FA



I numeri in giallo indicano la pagina di riferimento del listino Prezzi 2024-2025

PALLAMANO - Handball



pg.41
pg.42

Art. 7800G **1685,00€**
Coppia porte pallamano in acciaio mm. 80x80 (reti escluse)
Pair of steel handball Goals

Art. 7801G **2140,00€**
Coppia porte pallamano in alluminio mm. 80x80 (reti escluse)
Pair of aluminium handball Goals

Le reti per porte pallamano corrispondono alle reti per porte calcetto m. 3x2
Same nets as futsal goals 3x2 m.



Art. PM113T **265,00€**
Coppia reti Pallamano m.3x2 annodate in nylon text Ø mm.5 con tenda ammortizzatrice
Handball nets with shock-absorbing curtain



Art. BA25 / BA0 / BA29 / BA30
Pallone Pallamano Trial in gomma supersoft junior / femminile
Handball supersoft junior / size 2 in rubber



Art. PTI.HB **36,50€**
Lavagna Pallamano bifacciale, magnetica e cancellabile cm. 35x22
Handball tactical board



Special Price



Art. V29 / V30 / V49 / ULT49-3 / ULT30-3
ULT303.15 / ULT29-3 / ULT24-3
Pallone Pallamano Trial in gomma mono e triplo strato mis. 0-1-1,5-2-3
Trial Handball in rubber single and triple stratum size 0-1-1,5-2-3

Art. ULT34 / ULT35 / ULT36-3 / ULT37-3
Pallone Beach Handball Trial in gomma triplo strato mis. 00, 0, 2, 3
Trial Beach Handball in rubber size 00, 0, 2, 3

Art. ULTS29 / ULTD29
ULTS30 / ULTD30
ULTS49 / ULTD49
Pallone Pallamano Trial in gomma potenziato Ø cm. 15/17/18,5 gr. 375/500/550/630/700/750 (+50% / +100%)
Rubber Trial Heavier Handball



Art. SH1
Pallone Pallamano Trial Micro/Midi Handball per l'apprendimento dei fondamentali
Trial Rubber Micro/Midi Handball helps in learning the basics



Art. TRBH
Pallone Reaction Ball Trial doppio strato rimbalzo e traiettorie imprevedibili
Trial Reaction Ball unpredictable rebounds for Handball

TABELLONI ELETTRONICI BASKET, PALLAVOLO, MULTISPORT Electronic scoreboards for basketball, volleyball, multisport

FORNITURE ■ ■ ■ ■ ■
& STAMPE

FORNITURE ■ ■ ■ ■ ■
& STAMPE

FORNITURE ■ ■ ■ ■ ■
& STAMPE



955,00€

Art. F160

Tabellone portatile MULTISPORT da tavolo con tastiera di comando per BASKET, VOLLEY, CALCETTO, PALLANUOTO, PALLAMANO, KICK BOXING, PING PONG ed altro punteggi da 0 a 199 per lato set/bonus/falli da 0 a 9 per lato cronometro massimo 99 minuti e 59 secondi periodi da 0 a 9 - altezza cifre cm.9 dim. cm. 55x35x9,5
Multisport Table Scoreboard (for BASKET, VOLLEY, FUTSAL, WATER POLO, HANDBALL, KICK BOXING, TABLE TENNIS)

pg.37

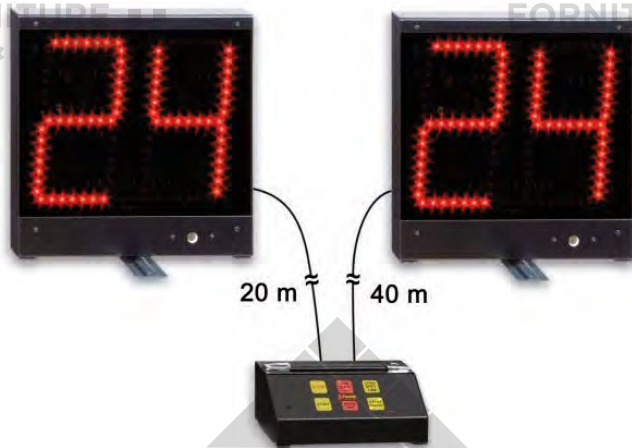

1182,00€

Art. F270

Kit indicatori elettronici 24 secondi h. cifre cm.20 - dim. cm.29,2x30,4x4,4 cadauno completo di console munita di tastiera visualizzazione del tempo di tiro e del timeout segnalatore acustico di fine tempo, un cavo m.20 e un cavo m.40 in dotazione
Kit 24 second indicators with console

FORNITURE ■ ■ ■ ■ ■
& STAMPE

FORNITURE ■ ■ ■ ■ ■
& STAMPE



2660,00€

Art. F268-02

Kit indicatori elettronici 24-30 secondi wireless h. cifre cm.20 - dim. cm.28,5x32x10 cadauno completo di console Art. F308-01 con valigetta e ricevitore radio, visualizzazione del tempo di tiro segnalatore acustico di fine tempo
Kit 24 second indicators wireless with console Art. F308-01 (with case) and radio receiver

pg.38

FORNITURE ■ ■ ■ ■ ■
& STAMPE

FORNITURE ■ ■ ■ ■ ■
& STAMPE

FORNITURE ■ ■ ■ ■ ■
& STAMPE



2123,00€

Art. F3045015

Tabellone segnapunti MULTISPORT dimensioni cm.91x60x9,5
peso Kg.10 - utilizzabile per BASKET, VOLLEY, CALCETTO,
PALLAMANO, PALLANUOTO, TENNIS, PING PONG, BADMINTON

altezza cifre cm.15 - visualizzazione di punteggi, cronometro, timeout, falli squadra, periodo, possesso palla
console Art. F308-01 non inclusa, ricevitore radio incluso
Electronic Board, dim. 91x60x9,5 cm.
15 cm. high figures for various sports
console Art. F308-01 not included, radio receiver included



pg.37

1450,00€

Art. F308-01

Console 700 per

Art. F3045015 e Art. F3045025

Display touchscreen utilizzabile per
collegamento sia via cavo che via radio
dim. cm.24,5x17x8,5

alimentata da rete o con batteria al litio ricaricabile

Console for Art. F3045015 and Art. F3045025
with cable or radio system



3579,00€

Art. F3045025

Tabellone segnapunti MULTISPORT omologato FIBA livello 3 utilizzabile per
BASKET, VOLLEY, CALCETTO, TENNIS, PING PONG, PALLAMANO, PALLANUOTO, BADMINTON

altezza cifre cm.25 distanza di leggibilità m.110 - peso Kg.22 - dimensioni cm.140x83x9
da utilizzare con console Art. F308-01 (non inclusa), ricevitore radio incluso

Electronic Board, dim. 140x83x9 cm. - 25 cm. high figures for various sport
console Art. F308-01 not included, radio receiver included



Art. F242

6490,00€

Tabellone MULTISPORT FS-130
 dimensioni cm.200x180x9 - peso Kg.60
 costruito secondo le disposizioni FIBA
 utilizzabile per BASKET, VOLLEY, CALCETTO,
 PALLAMANO, HOCKEY, TENNIS, PALLANUOTO
 altezza cifre cm.30 tempo di gioco 99:59
 punteggi di squadra (da 0 a 199) - periodo (0 - 9)
 falli di squadra/set vinti (da 0 a 9) - bonus
 (1 punto luminoso per squadra)
 timeout (3 punti luminosi per squadra)
 possesso/servizio/turno: frecce indicatrici
 indicazione ultimo fallo avvenuto
 (numero di maglia del giocatore e numero del fallo)
 Console Art. F308-01 non inclusa, ricevitore radio
 Art. F265-20 non incluso

Electronic Board, dim. 200x180x9 cm.
 30 cm. high figures for various sport
 Console Art. F308-01 not included,
 radio receiver Art. F265-20 not included



1450,00€

Art. F308-01

Console 700 per Art. F242
 Display touchscreen - utilizzabile per
 collegamento sia via cavo che via radio
 dim. cm.24,5x17x8,5
 alimentata da rete
 o con batteria al litio ricaricabile
 Console for Art. F242
 with cable or radio system

pg.38



1804,00€

Art. F258-51

**Tabellone elettronico indicatore
 24 secondi e tempo di gioco FS-24s-1**
 dim. cm.70,5x60x11,5 h. cifre cm.14
 e cm.30 - da collegare con
 Art. F253-21, completo di cavo m.50
 per collegamento alla console
 Art. F308-01 - protetto contro gli urti
 della palla - *N.B. Per un impianto
 Basket completo occorrono
 n. 2 Art. F253-21 + n. 2 Art. F258-51
 24 second indicator board*

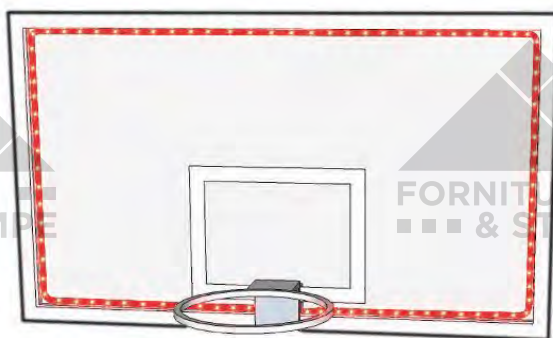

1304,00€

Art. F253-21

**Kit cornice luminosa e centralina di comando
 per tabellone basket Ledstrip cm.515**
 Kit light frame and control unit for basketball board
 Ledstrip 515 cm.



458,00€

Art. F265-20

**Ricevitore radio per collegamento del
 tabellone indicatore 24 secondi**
 Art. F258-51 alla console Art. F308-01
*N.B. Per un impianto
 Basket completo occorrono
 n. 2 Art. F253-21 + n. 2 Art. F258-51
 + n. 2 Art. F265-20*
 Radio receiver connecting
 Art. F258-51 to Art. F308-01

851,00€

TENNIS

Art. 8820G
Coppia Pali Tennis in acciaio verniciato a sezione quadra con bussole da interrare e tendirete
Tennis Posts in painted steel with underground sockets

425,00€

914,00€

Art. 1056
Coppia Pali Tennis in acciaio zincato e verniciato a polvere sezione quadra con bussole da interrare e tendirete in bronzo ad arganello
Tennis Posts in galvanized and painted steel with underground sockets

Art. 1059
Coppia Pali Tennis da fissare al pavimento in alluminio e tendirete in bronzo ad arganello
Tennis Posts in aluminium for ground fixing

pg.42

Art. 1058
Coppia Pali Tennis da fissare al pavimento in acciaio verniciato a sezione quadra e tendirete in bronzo ad arganello
Tennis Posts in painted steel for ground fixing

800,00€

Art. 1056ZA
Come Art. 1056 ma verniciato acrilico liquido
Same as Art. 1056 but painted liquid acrylic

612,00€



Art. 8819G
Coppia Pali Tennis in alluminio con bussole da interrare e tendirete
Tennis Posts in aluminium with underground sockets

660,00€



Art. T030
Rete Tennis annodata m.12,80x1 - sp. mm. 2,5 (centro rete non incluso)
Tennis knotted net (Art. RT1 not included)

155,75€



Art. T050
Rete Tennis annodata m.12,80x1 super pesante da gara - spessore mm. 3,5 (centro rete Art. RT1 non incluso)
Tennis knotted match net (Art. RT1 not included)

307,00€

Art. RT1
Centro rete
Net central holder

19,65€



518,00€

Art. G8835
Seggiolone verniciato per arbitro
Painted referee's Chair



678,50€

Art. TE10030
Impianto Junior Tennis cm. 500x100 in acciaio trasportabile (rete esclusa)
Transportable junior Tennis posts in steel (net not included)

100,50€

Art. TE10031
Rete per impianto Art. TE10030
Net for Art. TE10030

2457,00€

Art. S04862
Impianto Tennis in acciaio zincato trasportabile (rete e zavorra escluse)
Transportable Tennis posts in galvanized steel (net and weights not included)



Art. S04868
Coppia paletti per singolo in acciaio zincato
Pair of steel poles for single

59,70€



50,25€

42,40€

42,40€

Art. RTAD / RTB912 / RTB58

Racchetta Tennis Dunlop in lega
27" (adulti) - 25" (9/12 anni) - 23" (5/8 anni)
Tennis rackets



14,45€

Art. AGDP
Tubo 3 palle Tennis
Dunlop
depressurizzate
(rimbalzo ridotto
del 50% per scuole
tennis)
Set 3 depressurized
Tennis balls

pg.42

pg.43



12,50€

Art. 44.045 Over Grip

4,30€

Art. E6620
Paio Polsini
tergisudore
altezza cm. 7
Pair of
Wrist bands

3,50€

Art. E6610
Fascia
tergisudore
altezza cm. 5
Headband



9,55€

Art. T4D

Tubo 4 Palle Tennis
Head Championship
Set 4 Tennis Balls



16,35€

Art. T4DAC

Tubo 4 Palle Tennis
Dunlop Fort All Court
Set 4 Tennis Balls

113,75€

Art. RT10
Stuoia livellatrice
per campi in terra
battuta m.2x1,5
Levelling net 2x1,5 m.



3,40€

Art. 07861 Set 3 palline tennis
in gommapiuma
Set 3 foam rubber tennis balls



DA PREVENTIVO

Art. TE220.40 Macchina
lancia palline
velocità max 130 km/h
velocità min 32 km/h
intervalli di lancio
da 2 a 15 secondi
Ball throwing machine

3030,00€

Art. TE51.04
Rullo in acciaio
con racla
Levelling roller



BEACH TENNIS - PADEL - PICKLEBALL

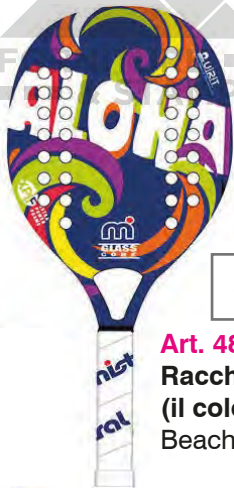

pg.42 pg.43

85,30€

Art. 48018
Racchetta Beach Tennis in resina
(il colore e la grafica possono variare)
Beach Tennis racket



4,30€

Art. PT41
Pallina Beach Tennis
Beach Tennis ball



142,80€

Art. P210
Rete Beach Tennis
m.8,50x1
con fettuccia
sull'intero perimetro
Beach Tennis net



128,90€

Art. T043
Rete Padel m.10x0,92
Padel net



10,05€

Art. TPAPD
Tubo 3 Palle
Padel
Dunlop Team
(o modello
simile)
Set 3 Padel Balls



87,50€

Art. RPDH
Racchetta Padel
XQMAX
Hurricane/Prox
(o modello simile)
Padel Racket



71,90€

Art. P121
Rete Pickleball m.7x0,9
Pickleball net



25,60€

Art. PBRCK

**Art. PBPLI/
PBPLO**

8,75€

SET 6 PALLINE Pickleball indoor 26 fori
SET 6 PALLINE Pickleball outdoor 40 fori

New!



282,00€

Art. PBSET

Art. PBRCK SET 2 RACCHETTE Pickleball, 6 palline, custodia
Art. PBPLI SET 6 PALLINE Pickleball indoor 26 fori
Art. PBPLO SET 6 PALLINE Pickleball outdoor 40 fori
Art. PBSET SET Pickleball con rete portatile, 4 racchette, 6 palline, set righe campo, custodie



3,30€

Art. 0934N
Rete protezione
polietilene verde annodata
maglia mm. 45x45 sp. mm. 2
Protection Net green polyethylene
mesh 45x45 mm.
knotted, thick 2 mm.



332,75€ 287,50€

Art. 40/S - 41/S
Telo fondo campo Tennis
densità 90% o 70% mt.18x2
con banda di rinforzo
Tennis perimeter net density
90% or 70% dim. 18x2 meters



Front

Reverse

2 6
6 4
6 7
HOME VISITOR

7 6

New!

Art. TE53090

Tabellone segnapunti Tennis
cm. 46x65 h. cifre cm. 8
completo di agganci
per la recinzione
Tennis scoreboard 46x65 cm.

410,00€

TENNIS TAVOLO - Table Tennis

Art. BT36302
Racchetta
Ping Pong
Club 3 stelle
 3 star
 table tennis bat

7,30€



10,40€



41,80€

Art. 83925A
Racchetta
Ping Pong
Dunlop
Evolution 1000
 (o modello simile)
 Dunlop
 table tennis bat



pg.43 pg.44

Art. 568001
Racchetta Ping Pong
Dunlop Nitro
 (o modello simile)
 Dunlop table tennis bat

28,25€



5,85€

Art. BT35101
Confezione 6 Palline
Ping Pong 3 stelle
 Set of 6 table tennis balls
 3 stars



44,90€

Art. 2C4118C
Confezione 100 Palline
1 stella colore bianco
 Set of 100 table tennis balls
 1 star



Art. 48441
Confezione 6 Palline
Dunlop Championship
1 stella
 Set of 6 table tennis balls
 1 star

6,80€

Art. 17362
Confezione 3 Palline
Stiga 3 stelle Perform
 Set of 3 Stiga
 table tennis
 balls 3 stars



2,55€

Art. PP50
Rete in polietilene
 Table Tennis Net



19,70€

Art. E5019
Rete Ping Pong
regolabile portatile universale
 Table tennis net adjustable length



28,25€

Art. 48448
Set rete con paletti
 Table Tennis Net
 with holder



59,50€

Art. PPP30
Segnapunti per Ping Pong
 (numeri da 0 a 30 non divisi)
 Table tennis scoreboard





Art. C-163I
Tennis tavolo
modello PROGRESS da interno
Indoor Table Tennis PROGRESS

563,00€

Art. C-163E
Tennis tavolo
modello PROGRESS da esterno
Outdoor Table Tennis PROGRESS

887,00€



Art. C-277I
Tennis tavolo
modello ADVANCE da interno
Indoor Table Tennis ADVANCE

731,00€

pg.43



Tutti i tavoli sono pieghevoli
e su ruote
All models are foldable
and on wheels



RUGBY



Art. 8836G1 / 8836G
Coppia Porte Rugby
in alluminio verniciato
m. 11 / m. 9,6 fuori terra
Rugby Goals
in painted aluminium

6730,00€

6370,00€

298,00€

324,00€

303,00€

Art. 993156 / 993157 / 993162
Protezione imbottita per palo porta rugby
h. cm. 200, modello quadrato oppure tondo
Soft Protection for rugby goal post, square and round shape, height 200 cm.



20,40€

Art. V71
Pallone mini-rugby Trial
in gomma monostrato
gr. 350 dim. cm.15/27
Trial rubber mini-rugby Ball
single stratum



Art. ULT71
Pallone mini-rugby Trial
in gomma doppio strato
gr. 350 dim. cm.15/27
Trial rubber mini-rugby Ball
double stratum

31,10€



Art. ULT70
Pallone rugby Trial
in gomma doppio strato
gr. 450 dim. cm.19/28
Trial rubber rugby Ball
double stratum

31,70€

pg.45



Art. W.MVP
Pallone football americano
in pelle sintetica
Wilson MVP ball

46,80€



80,70€

Art. 993164
Protezione copri bandierina
cm.10x10x100h.
Protection for rugby flag pole
10x10x100h. cm.





114,35€

Art. 993032
Scudo protezione
rugby cm.75x35x15
 Rugby Shield



275,00€

Art. 6M18
Confezione 100 Tacchetti rugby
mm.18 in alluminio
 Rugby aluminium studs
 18 mm. 100 piece pack

pg.45



372,60€

291,00€

Art. 993151 / 993153JR

Sacco placcaggio rugby h. cm.140 oppure
cm.120, diametro cm. 45 oppure cm. 35,
con 3 maniglie

Sac for tackling height 140 or 120 cm.
 diameter 45 or 35 cm. with 3 handles



36,50€

Art. PTI.RU

Lavagna Rugby bifacciale
magnetica e cancellabile
cm. 35x22
 Rugby tactical board
 35x22 cm.



36,50€

Art. PTI.FA

Lavagna Football
Americano bifacciale
magnetica e cancellabile
cm. 35x22
 American Football
 tactical board
 35x22 cm.

42,70€

Art. CFFST
Cintura Flag Football flag-a-tag
colori: rosso, blu, giallo, verde
 Flag Football flag-a-tag
 colors: red, blue, yellow, green



PISCINA - Swimming Pool



Art. E1901
Cuffia in poliester
(bicolore solo taglia adulto)
Polyester cap

1,45€



Art. E1903
Cuffia in lycra plus
Lycra cap

3,40€



Art. E1127
Cuffia in silicone
Silicone cap

4,30€



Art. E2607
Stringinaso con
cuscinetti in silicone
Silicone nose-clip

2,95€



Art. E2608
Tappi auricolari in silicone
automodellanti - Set da 4 pezzi
Silicone auricular plugs

2,95€



Art. E2620
Occhialini
da piscina Junior
Junior glasses

5,65€



Art. E2626
Occhialini
da piscina adulto antifog
monococca morbida
Senior antifog glasses

5,85€



Art. E2618
Occhialini da piscina adulto antifog
monococca morbida
custodia con cerniera
Senior antifog glasses
case with zip

9,95€



Art. E2622
Occhiale maschera
antifog monococca morbida
con custodia rigida
Mask glasses antifog with case

15,60€

pg.44

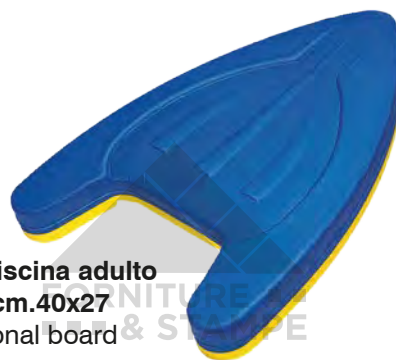

Art. E2639
Tavoletta per piscina adulto
professionale cm.40x27
Senior professional board

14,70€



Art. E2641
Ostacolatore monoblocco
cm.15x22x7,5
Swim hinder

11,20€



Art. E2650
Paio palette palmari forate
cm.21x16 (misura S, M, L)
Pair of perforated palm palettes

15,70€



Art. E2660
Copriscarpe in PVC
set da 2000 pezzi
misura unica
PVC shoe covers

202,50€



37,00€

Art. E848
Marsupio per nuoto potenziato
(ad esaurimento)
 Swimming pouch
 (until available)

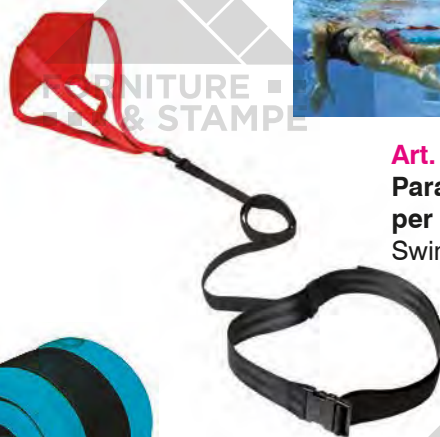

Art. E845 **31,50€**
Paracadute
per nuoto potenziato
 Swimming parachute



10,65€

Art. E482
Paio polsiere/cavigliere per aquagym
 mis. cm. 62x11x2
 Water aerobics
 wrist/ankle supports



32,15€

Art. E483
Paio manubri
per aquagym
 cm.30 - diam. cm.14
 Water aerobics
 dumbbells

pg.44

20,25€

Art. E488
Cintura per aquagym
 cm.72x24x4
 Water aerobics belt



119,90€

Art. E479/3
Zattera in espanso forata
 dim. cm.200x100x3
 Pierced mat



7,00€

Art. E2637/0
Paio manicotti arrotolabili
doppia valvola (3/6 anni)
 Brackets

9,55€

Art. E470
Cilindro
in materiale
espanso
per aquagym
 cm. 160 ø cm. 7
 Water aerobics bar

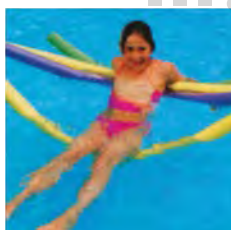

Art. E480/1
Connettore
per cilindro
 mis. cm.14 - 2 fori
 Bar connector

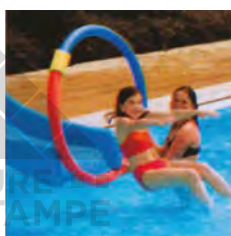

2,70€

New!



165,75€

Art. CMSAG
Step per aquagym
con ventose
 cm.67x35x17
 Water aerobics step
 67x35x17 cm.



PALLANUOTO - Waterpolo

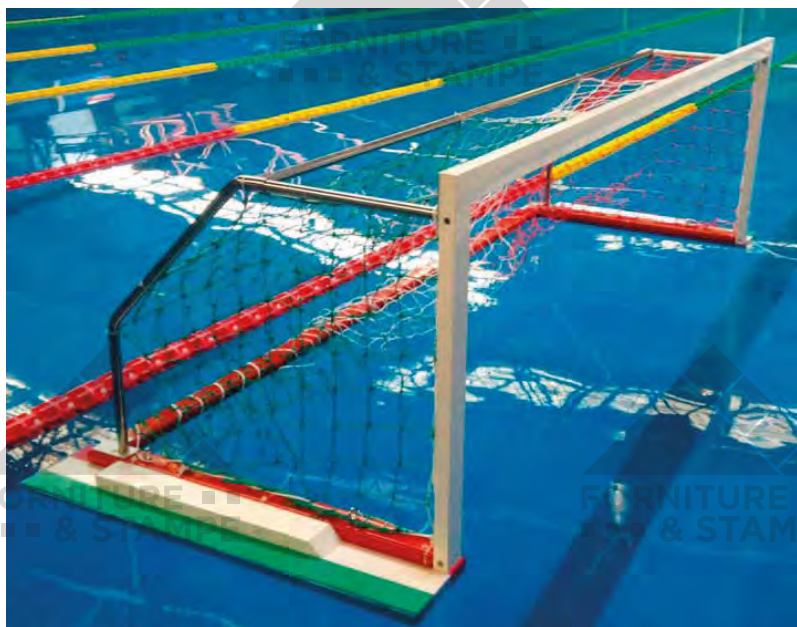

6335,00€

Art. PPNR

**Coppia Porte da pallanuoto
per partite ufficiali (reti incluse)**

Pair of Waterpolo Goals for official matches
(nets included)

- Realizzate a norma F.I.N.A.
- Luce interna specchio di porta m.3x0,90
- Ingombro totale m.3,50x0,975x1,25
- Specchio di porta tubolare alluminio mm.75x40x1,85 di colore bianco
- Base tubolare alluminio mm.80x40x3 colore rosso
- Accessori acciaio inox AISI 316
- Galleggianti schiuma espansa a cellule chiuse densità 350% - Peso kg.30

115,00€

Art. 175P

**Coppia reti per porte pallanuoto
Waterpolo Nets**

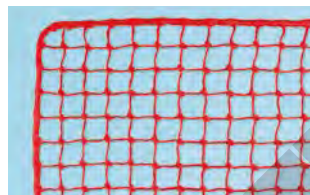

pg.44

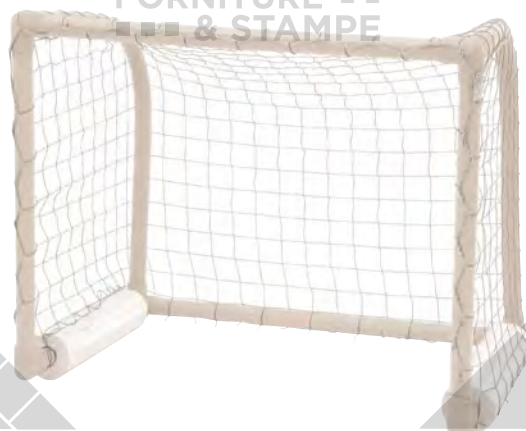

516,75€

Art. AQPP

**Coppia Miniporte
da pallanuoto in PVC m. 1,5x0,8
complete di reti**

Pair of Waterpolo PVC Mini-goals
1,5x0,8 m. nets included



19,90€

Art. E6890

**Pallone
pallanuoto
Waterpolo Ball**



Art. 30415

405,60€

**Set 13 cuffie pallanuoto
con numero**

colore bianco o blu

Set of 13 Waterpolo caps with numbers

BADMINTON



Art. P160
Rete
Badminton
cm. 610x70
Badminton Net

49,40€

V7700
538,00€

Impianto Badminton
professionale in acciaio verniciato
zavorrato, su ruote, con tendirete
(rete esclusa)
Pro Badminton set (net not included)



7,80€

Art. BT34327
Racchetta Badminton in acciaio/alluminio
Badminton Racket in steel/aluminium

pg.45



24,00€

Art. ASTF
Racchetta Badminton Torro Fighter Club
in acciaio/alluminio
Badminton Racket Torro Fighter Club
in steel/aluminium

22,60€



Art. BT33106
Confezione
6 Volani
Badminton
interamente
in plastica
Plastic
Shuttlecock
6 piece pack

5,85€



Art. AS85
Confezione
6 Volani
Badminton
con capsula
in sughero
Cork tip
Shuttlecock
6 piece pack



109,15€

Art. 013.SP
Impianto Mini Badminton cm. 450x170h. con rete e sacca
Mini Badminton set 4,5x1,7h. meter with net and bag

FURNITURE ■ ■ ■ ■
STAMPE

FORNITURE ■ ■ ■ ■
& STAMPE

BOXE

FORNITURE ■ ■ ■ ■
& STAMPE



173,00€

Art. 992030

Sacco Boxe in vinile Kg.30
Vinyl boxing bag kg.30



190,00€

Art. 992040

Sacco Boxe in vinile Kg.40
Vinyl boxing bag kg.40



220,00€

Art. 992050

Sacco Boxe in vinile Kg.50
Vinyl boxing bag kg.50



15,40€

Art. C3003S
Gancio a molla
ammortizzatore per
sacco boxe
Spring for boxing bag



Art. 993004
Supporto a muro
per sacco boxe
Iron wall support for
boxing bag

125,90€

FURNITURE ■ ■ ■ ■
STAMPE



534,00€

Art. 992840

Sacco Boxe basculante
h. cm. 170 zavorrato con
sacchi di sabbia (inclusi)
Self-straightening boxing bag
height 170 cm.



447,00€

Art. 992804

Sacco Fit Boxe con pedana
riempibile con acqua o sabbia,
altezza regolabile (max cm. 220)
Freestanding Fit Boxing bag
adjustable height



212,50€

Art. F350

Kit pera
su mensola
Pear for boxing

FURNITURE ■ ■ ■ ■
STAMPE

FORNITURE ■ ■ ■ ■
& STAMPE

FORNITURE ■ ■ ■ ■
& STAMPE



32,70€

Art. 42233A
Casco Boxe
misure S, M, L, XL
Boxing helmet



Art. 17211
Coppia Fasce Boxe
Boxing bandages

6,65€

40,50€

Art. 44613A
Set protezioni
parastinco +
parapiede
misure S, M, L, XL
Shin/foot protections

pg.53



Art. 54613A
Guanti da Sacco in PU
taglie S, M, L, XL
Bag gloves

22,05€



Art. 21796
Guanti Fit Boxe
taglie S, M, L, XL
Fit Boxing gloves

15,60€



Art. 74613A
Guanti MMA in PU
taglie S, M, L, XL
MMA gloves

26,30€



Art. 84613A
Guanti Boxe
per combattimento
non omologati
8/10/12 oz.
Boxing gloves

29,50€

pg.53



Art. GN083
Guanti Boxe
Leone Flash 10 oz.
Leone Boxing
gloves

57,90€

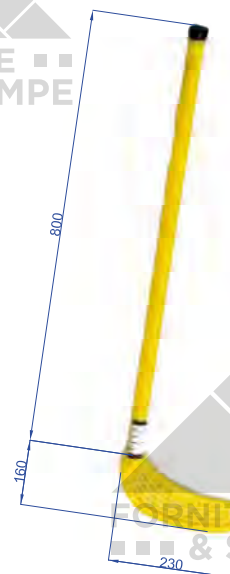

pg.44

Art. S05134

223,00€

Set Unihockey composto da 6+6 bastoni e 3 palline

Set Unihockey made of 6+6 sticks and 3 balls

4,70€

Art. PUH01
Pallina Unihockey
Unihockey ball



288,00€

Art. H1

Coppia RETI per porte da Hockey pista (indoor) in polipropilene maglia mm.45 cm.300x200x100x100

Pair of Track Hockey Goal nets

Art. H2

Coppia RETI per porte da Hockey ghiaccio in polipropilene complete di rete di sbarramento, maglia mm.20 - cm.193x122x75x120

Pair of Ice Hockey Goal nets

192,00€

Art. H3

Coppia RETI per porte da Hockey prato in polipropilene complete di rete di sbarramento, maglia mm.45 - cm.366x214x90x122

Pair of Field Hockey Goal nets

428,00€

Art. H4

Coppia RETI per porte da Hockey rotelle in polipropilene complete di rete di sbarramento, maglia mm.20 - cm.185x122x74x110

Pair of Roller Hockey Goal nets

207,50€



265,00€

Art. F806

Coppia porte Unihockey in acciaio verniciato con reti, dim. cm.150x110

Pair of Unihockey Goals in painted steel 150x110 cm.



65,60€

Art. TMB01
Mazza Baseball supersoft Trial
 lunghezza cm.71 diametro cm.4/5
 peso gr.460
 Supersoft Trial Baseball bat

BASEBALL



Art. S05152
Mazza Baseball regolamentare in legno
 Wooden Baseball bat

56,50€



16,50€

Art. S05156
Palla Baseball rivestita in pelle sintetica
 Baseball ball



69,00€

Art. S05158
Guantone Baseball in pelle sintetica
 misura senior
 Senior Baseball glove

pg.45

36,50€

Art. PTI.BB
Lavagna Baseball bifacciale, magnetica e cancellabile
 cm. 35x22
 Baseball tactical board
 35x22 cm.

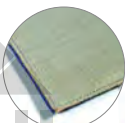

appoggio antiscivolo



imbottitura interna



166,20€

Art. P21006
Set basi didattiche antiscivolo colorate
 Set of didactic anti-skid bases



82,30€

Art. BSB.8
Set 7 Palle Baseball/Softball Trial in gomma super soft
 diametri e grammature assortiti
 Set of Trial Baseball/Softball balls



125,60€

Art. T21063
Batting tee Trial supersoft
 altezza regolabile da cm. 65 a cm. 86
 base diametro cm. 20,5
 peso Kg. 3
 Trial Batting tee adjustable height

FORNITURE ■ ■ ■ & STAMPE **MATERASSI - TAPPETI - Mats** ■ ■ ■ & STAMPE



Art. B2001/ ... /B2016

Materassi di caduta realizzati in gommapiuma di varie densità con fodera di rivestimento in PVC antimuffa, antibatterico, ignifugo Cl.2

(vedere listino per le dimensioni)

Mats of various dimensions and thickness

Materassi e fodere disponibili anche con fondo antiscivolo (dettagli sul listino prezzi)

Mats and covers also available with anti-skid bottom (details on price list)

● pg.46 ● pg.47

Art. B2033/ ... /B2047

Fodere di ricambio in PVC antimuffa, antibatterico, ignifugo Cl.2

(vedere listino per le dimensioni)

Spare covers for mats various dimensions



Particolare Art. B2014/ B2015/B2016

(i materassi cm.200x400 sono costituiti da due metà tagliate a 45° e tenute insieme da bande in velcro)

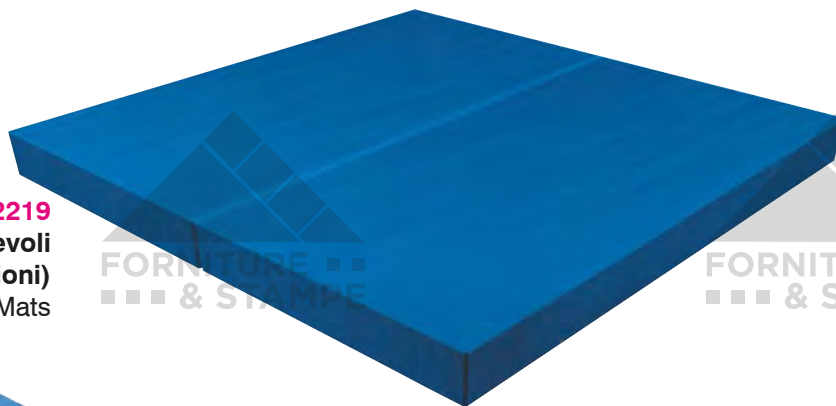

Art. B2214/ ... /B2219

Materassi di caduta pieghevoli (vedere listino per le dimensioni)

Foldable Mats



Più rigidi e compatti dei materassi in gommapiuma
Harder than foam rubber mats

Art. B2228/ ... /B2231

Tappeti Gym Mat dim. cm.200x100 spessore cm.3-4-5-6 ad alta densità in polietilene a cellule chiuse per uscita attrezzi
High density Gym Mats

Particolare Art. B2228/ ... /B2231

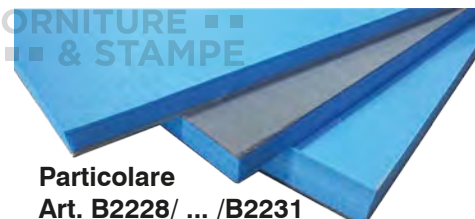

658,00€

Art. S00676

**Carrello porta materassi
cm. 200x100
in acciaio verniciato
mobile su ruote**

Mat Trolley in painted steel size
200x100 cm. on wheels

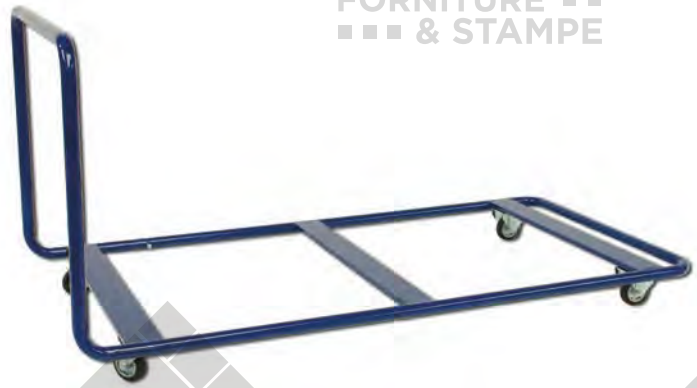

pg.47

1046,00€

Art. S00678

**Carrello porta materassi
in verticale cm. 250x105
in acciaio verniciato
mobile su ruote
(elastici inclusi)**

Vertical mat Trolley in painted
steel size 250x105 cm.
on wheels
(elastics included)



682,00€

Art. TEST.M

**Tappeto Mat Test cm.100x370
con scala centimetrata da 0 a cm. 300
Mat Test 100x370 cm.**

Per allenamento tuffi portieri ed acrobazie giocatori
For GK dive and players' acrobatic shooting training

pg.46

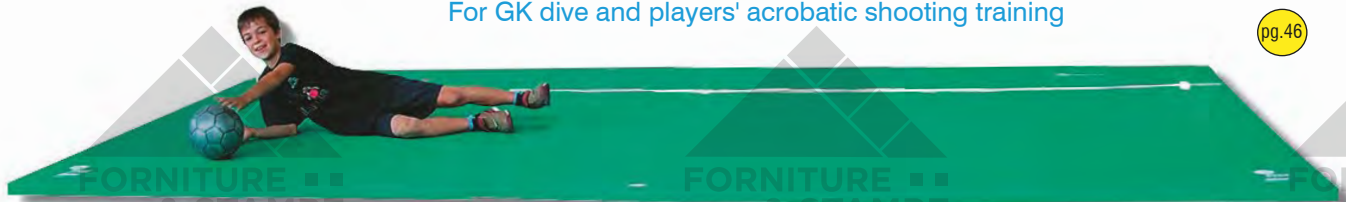

Art. BGAP13

**Tappeto ammortizzante pieghevole dimensioni cm. 200x450 spessore cm. 3,5
superficie in vinile, fondo antiscivolo, imbottitura in gommapiuma densità 40 Kg/mc
Foldable soft mat for goalkeeper and players' safe dives - size 200x450 cm. 3,5 cm. thick**

965,00€



ARTI MARZIALI- Martial Arts



60,25€

Art. 24772
Divisa judo con cintura
misure da 00 (cm.120)
a 7 (cm.200)
Judo strip with belt

pg.53



42,60€

Art. 24773
Divisa karate con cintura
misure da 00 (cm.120)
a 7 (cm.200)
Karate strip with belt



5,75€

Art. 23271
Cintura judo/karate 100% cotone
colori: nero, blu, arancio, marrone,
verde, giallo, rosso
misure da 1 a 7
Judo/Karate belt



8,70€

Art. 23271.B
Cintura judo/karate 100% cotone
bicolore: bianco/giallo, giallo/arancio,
arancio/verde, verde/blu,
blu/marrone - misure da 1 a 7
Bicoloured Judo/Karate belt

379,00€

Art. F150
Fight Timer da parete
cm.56x19x4 - kg.1,6
Fight Timer





Art. R10X **26,70€**

TATAMI ad incastro in EVA cm.100x100x1
colore blu con 4 bordi
superficie lavabile, antiscivolo
 EVA Tatami soft flooring 100x100x1 cm.

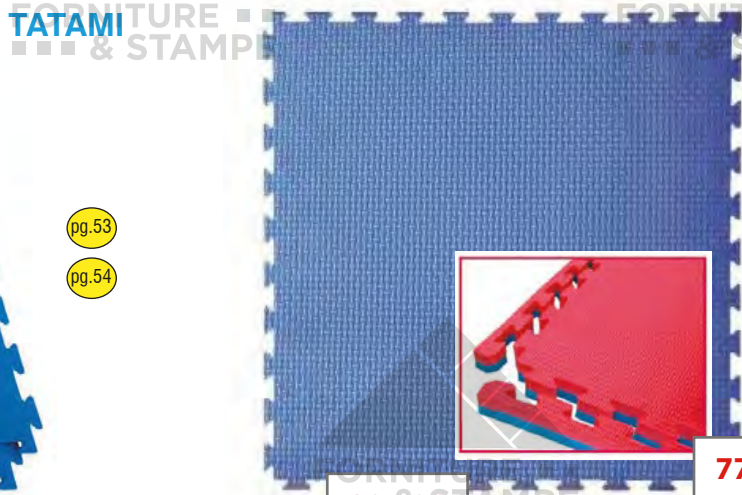

pg.53

pg.54

39,50€ Art. MAT02 / MAT04 **77,80€**

TATAMI ad incastro cm.100x100x2
o cm.100x100x4 rosso/blu con 4 bordi
superficie lavabile, antiscivolo, antifunghi,
antibatterica, anallergica, certificato EN71
 Tatami soft flooring 100x100x2 cm./100x100x4 cm.



58,10€ Art. TX-K20

TATAMI Karate K20
cm. 100x100x2 ad incastro, reversibile
in polietilene espanso reticolato
incluso bordo protettivo perimetrale
colori: verde/rosso, rosso/blu, giallo/blu
(ordine minimo 8 pezzi)
 TATAMI K20 100x100x2 cm.
 reversible, perimetric frame included
 colors: red/green, red/blue, yellow/blue
 (minimum order 8 pieces)

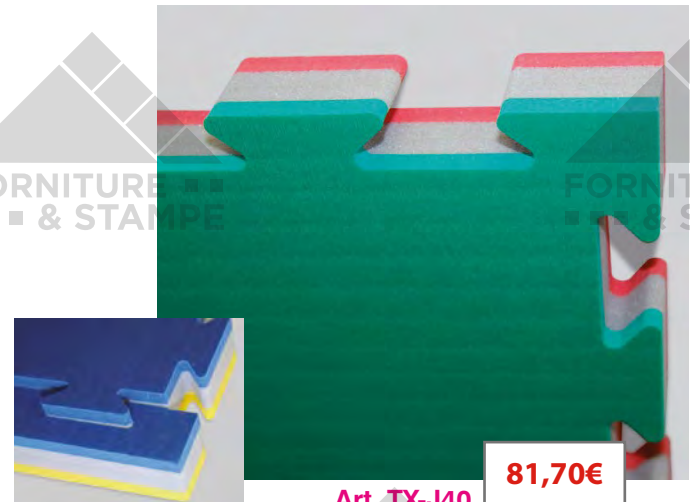

Art. TX-J40 **81,70€**

TATAMI Judo J40
cm. 100x100x4 ad incastro, reversibile
in polietilene espanso reticolato
incluso bordo protettivo perimetrale
colori: verde/bianco/rosso, giallo/bianco/blu
(ordine minimo 4 pezzi)
 TATAMI J40 100x100x4 cm. reversible,
 perimetric frame included
 colors: red/white/green, yellow/white/blue
 (minimum order 4 pieces)

243,00€

Art. TX-2010
TATAMI tradizionale
cm. 200x100x4 in PU
densità 230 Kg/mc
rivestito in PVC
con fondo antiscivolo
colori: blu, verde, rosso, giallo
(ordine minimo 4 pezzi)
 TATAMI 200x100x4 cm.
 in PU density 230 Kg/mc
 cover with anti-skid PVC stratum
 colors: blue, green, red, yellow
 (minimum order 4 pieces)

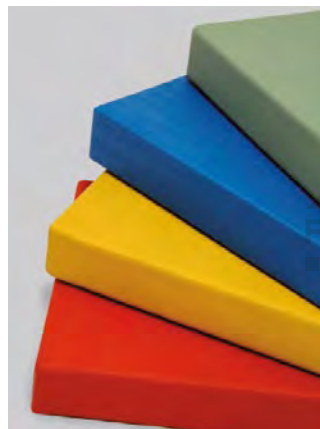

PROTEZIONI MURARIE E PER COLONNA - Wall protections



190,00€

190,00€

Art. B2085 / B2066

Protezioni murarie e per colonna in vari spessori sagomate su misura in EVA oppure in PE ad alta densità rivestito in PVC fissaggio tramite occhiellature perimetrali, velcro oppure colla per interno ed esterno

Customized wall and column protections various thickness for indoor and outdoor



pg.46

Art. PPVCI

190,00€

Protezione parasigolo in PVC ignifugo Cl.1 lunghezza cm. 200, spessore mm. 2 larghezza cm. 3,5+3,5 in vari colori
PVC edge protection length 200 cm. width 3,5+3,5 cm. 2 mm. thick

Si taglia facilmente alla misura desiderata e si applica rapidamente mediante normale silicone
it can be easily cut to the desired size and installed quickly with standard silicone

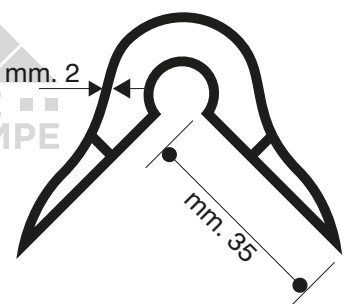



955,00€

Art. S00352

Armadio porta attrezzi a 4 ripiani in lamiera con vano portavalori dimensioni cm. 100x45x200h

Equipment locker with safe-deposit box



834,00€

Art. S00354

Armadio porta attrezzi a 4 ripiani in lamiera dimensioni cm. 100x45x200h

Equipment locker



1500,00€

Art. F406

Armadio porta attrezzi in acciaio zincato a pareti smontabili, con ruote dimensioni cm. 156x76x163h

Equipment locker in galvanized steel on wheels

pg.23



190,00€

Art. S00356

Armadio porta attrezzi in lamiera dimensioni cm. 120x45x200h a 4 ripiani e porte scorrevoli

Equipment locker with sliding doors

pg.48

190,00€

Art. S00362

Mobile porta attrezzi su ruote

Equipment trolley on wheels



FORNITURE ■ ■ ■
& STAMPE



61,15€

Art. CAGL

Coppia anelli in legno di faggio
con cinghie nylon regolabili

Pair of wooden rings with adjustable nylon belts

pg.48

Art. S00002
Coppia anelli
in legno lamellare
Pair of wooden rings

125,60€



40,80€

Art. S00018

Confezione da 8 pani
magnesio gr. 55
Chalk blocks



pg.48

188,50€

Art. S00512

Mensola porta clavette
Club wall holder



13,45€

28,25€

53,40€

Art. P00510/S00502/S00506

Coppia clavette in nylon,
in legno a collo lungo e collo corto
Wooden and plastic clubs



Art. E8000

Paio scarpette in pelle
per ginnastica ritmica
colore nero o bianco
taglie da 26 a 46

12,30€

Pair of shoes for rhythmic gym
color black or white



4,75€

Art. CS5

Corda salto
per ritmica
m. 3

Jumping rope



12,50€

Art. P01210

Nastro per ginnastica
ritmica m. 6

Rhythmic
gym streamer

pg.48



6,10€

Art. CS7

Corda salto
per ritmica
m. 3 piombata
Weighted jumping
rope



72,25€

Art. S01482

Tamburello
completo
di batacchio
Rhythmic
gym drum



637,00€

pg.49

Art. S01624

Specchio quadrettato
con cornice
in legno da fissare a parete
misure cm.200x100
Wall mirror with wooden frame

I numeri in giallo indicano la pagina di riferimento del Listino Prezzi 2024-2025

FORNITURE ■ ■ ■ ■ ■
& STAMPE



110,00€

Art. S01606
Supporto per sbarra regolabile da fissare a parete
Support for bar to be fixed on the wall

pg.49

41,00€

Art. S01602
Sbarra per danza in legno (pezzo unico fino a 4 metri)
Wooden bar

FORNITURE ■ ■ ■ ■ ■
& STAMPE



190,00€

Art. 1156TE
Supporto per sbarra regolabile da cm. 78 a cm. 140 in acciaio con base autoportante economica
Cheap freestanding support for bar



Art. S01608
Supporto per sbarra regolabile da fissare a terra
Support for bar to be fixed on the floor

330,00€



pg.48

19,50€

Art. S00304
Coppia ceppi Baumann in legno
Pair of Baumann blocks in wood



47,10€

Art. S00302
Coppia appoggi Baumann in legno
Pair of Baumann supports in wood

FORNITURE ■ ■ ■ ■ ■
& STAMPE

FORNITURE ■ ■ ■ ■ ■
& STAMPE

FORNITURE ■ ■ ■ ■ ■
& STAMPE



703,00€

758,00€

1759,00€

2214,00€

Art. S01052 / S01054 / S01060 / S01062
Scale ortopediche dritte o curve, a parete o trasportabili, lunghezza m. 3
Orthopaedic ladders 3 meter long

pg.49



Art. S00772/S00774
Fune per salita lunghezza m. 5/6
Climbing Rope length 5/6 m.

100,50€

109,90€



2365,00€

1092,00€

pg.48

Art. S00754 / S00756
Palchi di salita (dettagli sul listino prezzi)
Climbing apparatus



411,00€

637,00€

Art. S00792/2 - S00792/3
Sistema di sospensione ed accostamento a parete per attrezzi da arrampicata (funi, pertiche, scale)
Varnished steel frame for supporting and sliding climbing equipments to the wall, once not in use (ropes, poles and ladders)

Numbers in yellow show the relevant page on 2024-2025 Price List

I numeri in giallo indicano la pagina di riferimento del Listino Prezzi 2024-2025



509,00€ **652,00€** **426,00€** **447,00€**

30cm 5m **30/50cm 5m** **3m** **4m**

pg.48

Art. S00056 / S00058 / S00052 / S00054
Assi di equilibrio ad altezza fissa e graduabile
 Balance beams adjustable and fixed height

FORNITURE & STAMPE

FORNITURE & STAMPE pg.49



FISSA **REGOLABILE**
1340,00€ **2281,00€**

Art. S00060 / S00064
Trave di equilibrio in alluminio rivestito lunghezza mt.5 ad altezza regolabile (a norme F.I.G.) oppure ad altezza fissa
 Balance beam 5 meters adjustable height 50-120 cm. or fixed height



538,00€



606,00€

622,00€

758,00€

pg.49

Art. S00204 / S00206 / S00208 / S00210
Pedane elastiche con piano di battuta in legno, ricoperto in gomma, ricoperto in moquette o a doppio molleggio
 Springboards



1395,00€

Art. S00104
Cavallo regolamentare per volteggio rivestito in pelle sintetica altezza regolabile
 Vaulting buck adjustable height

pg.48



1012,00€

Art. V1168
Cavallina regolamentare rivestita in similpelle altezza regolabile da cm. 90 a cm.130
 Vaulting buck adjustable height



25/100 **15/200**
2545,00€ **3033,00€**

pg.49

Art. S00218 / S00220
Tappeto arrotolabile per pedana corpo libero in poliuretano e moquette, rotolo da m. 15/25 larghezza cm. 100/200
 Gymnastic moquette floor, roll 15/25 m. long 100/200 cm. wide



667,00€ **424,00€**

Art. S00914/S00918/S00920
Panche svedesi
 Swedish benches

pg.14



3,5m
673,00€

Numbers in yellow show the relevant page on 2024-2025 Price List

● I numeri in giallo indicano la pagina di riferimento del Listino Prezzi 2024-2025

FORNITURE ■ ■
■ ■ ■ & STAMPE

1875,00€

Art. S00252

**Sbarra orizzontale
per volteggi regolabile in
altezza, fissaggio
a terra con tiranti**
Vaulting bar adjustable height

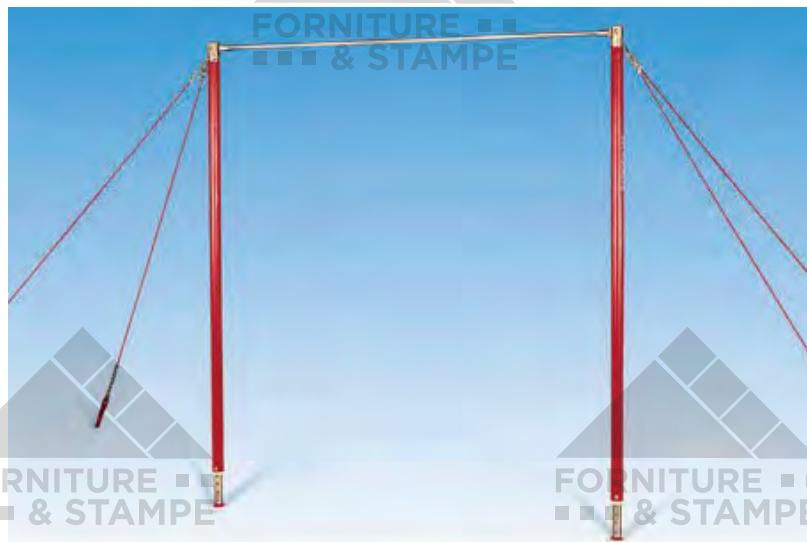

FORNITURE ■ ■
■ ■ ■ & STAMPE

FORNITURE ■ ■
■ ■ ■ & STAMPE

FORNITURE ■ ■
■ ■ ■ & STAMPE

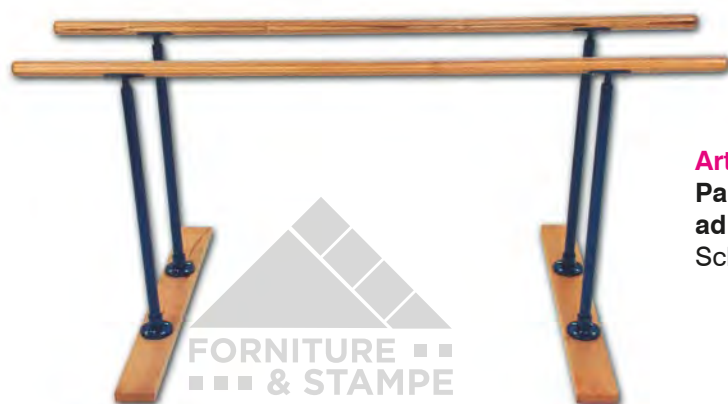

2032,00€

Art. S00160

**Parallela Scolastica a losanga
ad altezza fissa, staggi in legno lamellare**
School training parallel bars fixed height

FORNITURE ■ ■
■ ■ ■ & STAMPE

FORNITURE ■ ■
■ ■ ■ & STAMPE

FORNITURE ■ ■
■ ■ ■ & STAMPE

pg.49



4428,00€

Art. S00156

**Parallela Asimmetrica Femminile in acciaio verniciato
su basamento pesante, montanti graduabili,
staggi in legno lamellare regolabili in altezza e larghezza**
Asymmetrical parallel bars adjustable height

FORNITURE ■ ■
■ ■ ■ & STAMPE

FORNITURE ■ ■
■ ■ ■ & STAMPE

FORNITURE ■ ■
■ ■ ■ & STAMPE

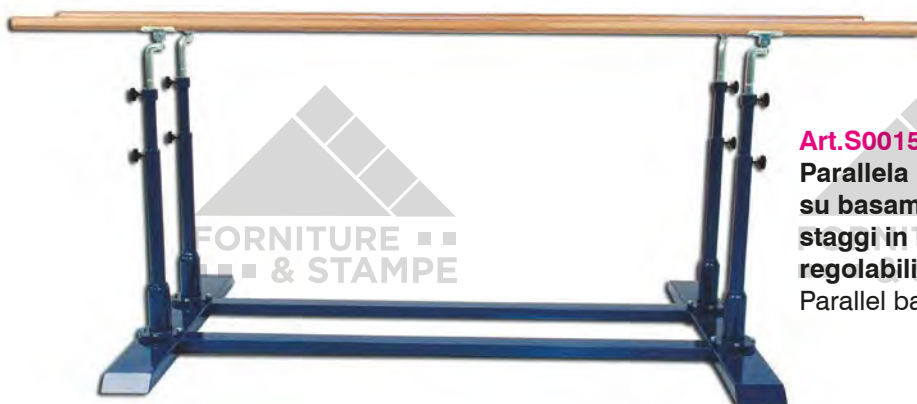

4131,00€

Art. S00152

**Parallela Maschile in acciaio verniciato
su basamento pesante, montanti graduabili,
staggi in legno lamellare
regolabili in altezza e larghezza**
Parallel bars adjustable height

FORNITURE ■ ■
■ ■ ■ & STAMPE

FORNITURE ■ ■
■ ■ ■ & STAMPE

● Numbers in yellow show the relevant page on 2024-2025 Price List

ATLETICA - Track & Field



209,30€

Art. PBS-SI

Blocco di partenza da allenamento
Polanik in acciaio zincato
Starting Blocks Polanik in galvanized steel

pg.49

62,15€

Art. BL01

Paio Blocchi di partenza in gomma per palestra
Pair of gym Starting Blocks in rubber for beginners

pg.50

1,10€

Art. TYVS

Pettorali in tyvek per gare atletica
cm.21x16h
personalizzabili
Numbers for competitions

BARRET®

1234



3,70€

Art. S02010/PPA38

Testimoni per staffetta
in PVC o omologati in alluminio
PVC or aluminium relay baton

13,90€



124,80€

Art. S02112

Megafono a transistor portatile
Handy megaphone

Art. F601

Ostacolo per Atletica in ferro zincato
graduabile cm. 50-60-76,2

109,00€

Adjustable height
hurdle in galvanized steel



157,75€

Art. S02126

Pistola a tamburo per starter
Starter's revolver gun

pg.50

778,00€

Art. PP1736A

Ostacolo per Atletica Polanik olimpionico da competizione
in alluminio anodizzato omologato W.A.

Adjustable height olympic hurdle in anodized aluminium according to W.A. standards



Art. F602

Ostacolo per Atletica in ferro zincato
graduabile cm. 76,2-84-91,4

113,00€

Adjustable height
hurdle in galvanized steel

Art. S02064

224,40€

Ostacolo per Atletica in acciaio zincato graduabile

cm. 76,2-84-91,4-100-106,7
Adjustable height hurdle in galvanized steel

Art. 6502U

386,00€

Ostacolo per Atletica Nordicsport olimpionico da competizione
in acciaio/alluminio omologato W.A.

Adjustable height olympic hurdle in steel/aluminium according to W.A. standards



ORNITURE ■ ■ ■ ■
■ ■ ■ ■ & STAMPE

ORNITURE ■ ■ ■ ■
■ ■ ■ ■ & STAMPE

ORNITURE ■ ■ ■ ■
■ ■ ■ ■ & STAMPE

346,00€



Art. S02552

Coppia ritti salto in alto scolastici altezza cm.200

Scholastic High Jump height 200 cm.

424,00€



Art. S02554

Coppia ritti salto in alto scolastici in acciaio zincato altezza cm.230

Scholastic High Jump height 230 cm.

712,60€



Art. S02556

Coppia ritti salto in alto in acciaio zincato periscopici h. cm.250

High Jump height 250 cm.

1016,00€



Art. S02558

Coppia ritti salto in alto in acciaio zincato periscopici da competizione h. cm.260

Competition High Jump height 260 cm.

(pg.52)

a moduli

Art. B2080/B2081

Zone di caduta salto in alto

High Jump landing mats

834,00€

583,00€



193,00€

Art. S02584

Piattaforma zincata di sostegno e sollevamento zona di caduta

Galvanized steel support platform for landing mats



67,90€

Art. S02566

Asta segnalimite per salto in alto in PTE

High Jump crossbar with soft PTE cylinders

172,50€

Art. S02570

Asticella segnalimite per salto in alto m. 4 in vetroresina

High Jump fiberglass crossbar



2515,00€

Art. PVS-CPTA

Coppia ritti per salto con l'asta in alluminio

graduabili fino a cm. 650

Pair of aluminium pole vault stands

690,00€

898,00€

a moduli

Art. B2077/B2078

Zone di caduta salto con l'asta

Pole vault landing mats

FORNITURE ■ ■ ■ ■
■ ■ ■ ■ & STAMPE



Art. TT09/ ... /VT15
Palle lancio
in gomma Trial
varie grammature
Trial rubber throwing balls

FORNITURE ■ ■ ■ ■
■ ■ ■ ■ & STAMPE



Art. VDL5/ ... /VDL72
Palle getto anelastiche
in gomma Trial
per indoor
varie grammature
Trial rubber shot balls
for indoor

FORNITURE ■ ■ ■ ■
■ ■ ■ ■ & STAMPE



Art. S02486/ ... /S02496
Palle getto in metallo verniciato
tarate, varie grammature
Metal shot balls



Art. S02510 **682,50€**
Pedana per lancio del peso
in acciaio zincato
Galvanized steel shot put throwing circle

pg.51



380,00€

Art. S02512
FermapiEDE getto del peso
in legno massiccio
Shot put toe board in wood

Art. STB-F100
FermapiEDE getto del peso
in vetroresina I.A.A.F.
Shot put toe board in fiberglass I.A.A.F.

485,00€



Art. CT6
Chiodo per scarpa
in acciaio mm.6 modello
Albero di Natale
(per corsa campestre)
Shoe steel stud 6 mm.

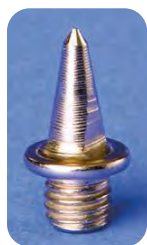

Art. P6 / P9 / P12
Chiodo per scarpa in acciaio
mm.6 - mm.9 - mm.12
modello Pyramid
(per pista)
Shoe steel stud 6 - 9 - 12 mm.

pg.50



Art. P15020
Pedana Lancio in neoprene espanso
per allenamento lancio del disco, giavellotto,
peso, martello e salto in lungo
Training toe board

67,50€



Art. LM0.5/ ... /LM5
Martelli sicuri supersoft
in gomma Trial
varie grammature
Supersoft Trial hammers

pg.52



Art. PM2/ ... /PM10
Martelli in acciaio da allenamento Polanik
Polanik steel hammers

I numeri gialli indicano la pagina di riferimento del Listino Prezzi 2012-2013



Art. DSK1/ ... /DSK2
Dischi in gomma Trial varie grammature
Discus in rubber Trial



Art. JET03 / JET05 / JET1
Dischi Jet in gomma Trial
Kg. 0,3/0,5/1
Jet discus in rubber Trial

pg.50

Dischi Jet speciali per avviamento al lancio con peso distribuito sulla parte esterna per favorire la penetrazione nell'aria
Special Jet discus with weight distributed mainly on the external perimeter in order to increase air penetration



Art. DT0.4/ ... /DT1
Dischi Trial a 3 impugnature in gomma approvati I.A.A.F. per attività scolastica
Trial discus approved by I.A.A.F. for school training

Art. W4T/ ... /W10T
Giavellotti Polanik in lega leggera con puntale in acciaio varie grammature
Polanik Javelins in light alloy with steel edge in various weights



Art. TPD075/ ... /TPD3
Dischi in plastica bordati in acciaio Polanik
Polanik discus in plastic-steel

Art. CPD1/ ... /CPD2
Dischi in plastica bordati in acciaio Polanik - omologati I.A.A.F.
I.A.A.F. Polanik discus in plastic-steel

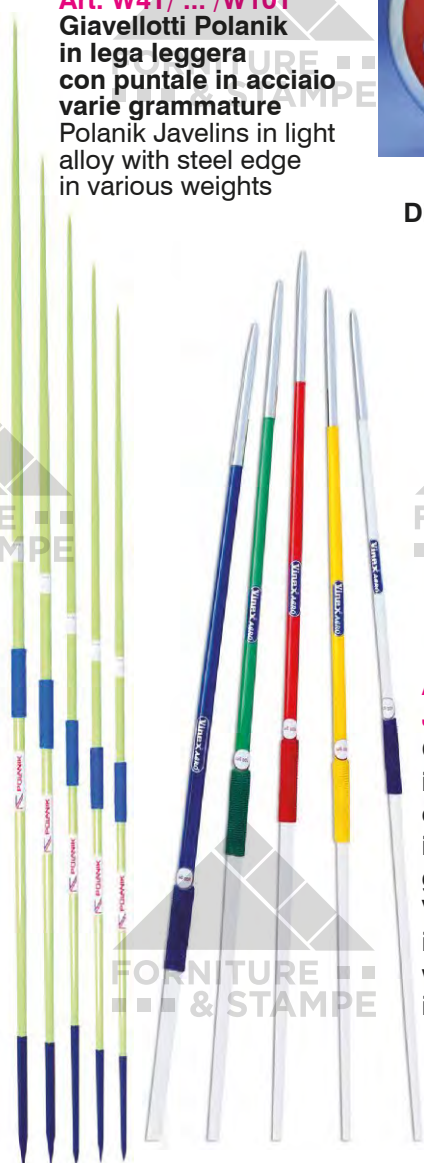

Art. TRTJ
42,40€
Turbo Jav per avviamento al lancio
Turbo Jav for throwing introduction

Art. P15262
34,25€
Junior Jav in polietilene espanso
cm. 88 gr. 50
Junior Jav

Art. JAL-C400/ ... / JAL-C800
Giavellotti Vinex in lega leggera con puntale in acciaio varie grammature
Vinex Javelins in light alloy with steel edge in various weights



Art. VMH
37,35€
Vortex per avviamento al lancio del giavellotto e per football americano
Vortex for throwing introduction



Art. VMH.J
25,75€
Mini Vortex gr. 40 lunghezza cm. 17
Mini Vortex

pg.50

pg.51

I numeri gialli indicano la pagina di riferimento del Listino Prezzi

I numeri in giallo indicano la pagina di riferimento del Listino Prezzi 2024-2025

PILATES



6,90€

Art. EVA.P

Mattoncino pilates in eva
cm.22,5x15x7,5h
Block for pilates



32,00€

Art. MPS30

Mattoncino pilates gonfiabile
Trial soft gr. 300 cm.12x24x3,5h
Inflatable block for pilates

Art. MPS50

Mattoncino pilates gonfiabile
Trial soft gr. 500 cm.11,3x24x5,5h
Inflatable block for pilates

34,20€



pg.54

6,90€

8,10€

Art. AHF-065/AHF-066

Sfera tonificante
verde kg.1 / viola kg.1,5
Toning balls

Art. AHF-045

Palla per yoga
ø cm.25
Yoga ball

5,65€



Art. BA4

31,00€

Palla tender per pilates
ø cm.20 - gr. 180
super soffice e sicura
Trial rubber tender ball
for pilates

17,75€

Art. TR38

Toning ring
Toning ring



Art. AHF-001

6,80€

Coppia sfere per massaggi
verde ø cm.7,5
viola ø cm.9
Massage balls

4,20€

Art. AHF-020

Power grip ball
Power grip ball

9,10€

10,35€

pg.21

Art. B55 / B75

Relax Ball Trial
ø cm.5,5 / 7,5
Relax Ball

Art. 995025

Cilindro pieno
Foam roll

35,50€

lunghezza cm. 90
ø cm.15
Foam roll not
inflatable



52,25€

Art. FY9512

Fitball roller
gonfiabile
ø cm.18
Fitball roller inflatable



18,20€

Art. 995025BIS

Mezzo cilindro
pieno Foam roll
lunghezza cm. 90
altezza cm.7,5
Half Foam roll
not inflatable

23,20€

Art. AHF-044

Rullo massaggio
lunghezza cm.33
ø cm.14
Massaging roll

16,50€

Art. AHF-111

Rullo massaggio
con impugnature
cm.53 ø cm.4,5
Massaging roll

110,20€

Art. TBSA/TBSB

Palla Boa autobilanciante in gomma Trial
oscilla ma torna al suo posto senza rotolare,
stabile, ideale per correggere la postura,
monocolore per adulti/bicolore per bambini
Trial rubber Boa Ball swings but comes back
to its original position - very good for postural
therapy for adults and children

PALLAPUGNO - BOCCE - TAMBURELLI



18,20€

Art. BA1

Air Ball Trial Ø cm. 12 gr. 100 morbida e rimbalzante (ideale anche per pallapugno)
Trial Air Ball

pg.54



7,30€

Art. M05010

Pallapugno FIPAP Ø cm. 14 gr. 65 FIPAP pallapugno

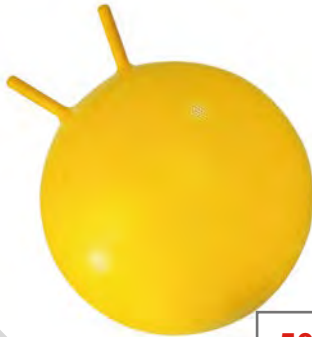

50,50€

Art. ST14

Palla Canguro Ø cm. 45
Trial Cangaroo Ball



61,25€

Art. ST15

Palla Canguro Ø cm. 55
Trial Cangaroo Ball



74,40€

Art. ST16

Palla Canguro Ø cm. 65
Trial Cangaroo Ball



91,10€

Art. ASKB

Set 8 bocce in legno laccato Ø mm. 100 con pallino Ø mm. 40
Set 8 wooden bowls

243,60€

Art. BTST12

Set 6+6 bocce supersoft con pallino e borsa
Set of 12 supersoft bowls with bag



pg.54

50,60€

Art. P18110

Tamburello indoor Ø cm. 26 (fino a 13 anni) omologato FIPT
FIPT indoor tamburello Ø cm. 26

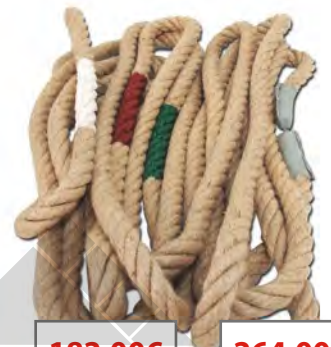

4,30€

Art. PT41

Pallina per tamburello depressurizzata indoor Ø cm. 6,5 gr. 40
Tamburello indoor depressurized ball



54,35€

Art. P18111

Tamburello indoor Ø cm. 28 omologato FIPT
FIPT indoor tamburello Ø cm. 28

182,00€

Art. S00552 / S00556
Fune per tiro alla fune lunghezza m. 15 / m. 25 con indicazioni colorate
Rope for tug of war length 15 m. / 25 m.

264,00€

I numeri in giallo indicano la pagina di riferimento del listino Prezzi 2024-2025



152,00€

Art. I-059

Set 10 mattoncini dritti
cm. 25x16x13h
Set of 10 straight bricks



152,00€

Art. I-060

Set 10 mattoncini curvi
cm. 22x16x13h
Set of 10 curved bricks



24,80€

Art. I-098

Blocco percorso
cm. 30x15x10h
Block for route



446,00€

Art. I-061

Percorso equilibrio composto da 5 assi + 6 mattoncini + 24 ventose
Balance route



PALLA
AVVELENATA
Dodgeball

19,60€

Art. TDB16

Palla per Dodgeball diametro cm. 16
peso gr. 210 colore arancio fluo
Dodgeball Ø 16 cm.

pg.54

Art. TDB20

Palla per Dodgeball diametro cm. 20
peso gr. 230 colore giallo fluo
Dodgeball Ø 20 cm.

20,35€

Special
Price

Numbers in yellow show the relevant page on 2024-2025 Price List

FORNITURE ■ ■ ■ ■ & STAMPE ■ ■ ■ ■ SKATEBOARD - PATTINI - MONOPATTINI - FRISBEE ■ ■ ■ ■ FORNITURE ■ ■ ■ ■ & STAMPE ■ ■ ■ ■



42,70€

Art. SKM2401 Skateboard Junior cm. 61
Junior Skateboard 61 cm.



55,80€

Art. SKM3103 Skateboard Senior cm. 77,5
Skateboard 77,5 cm.



34,50€

Art. F4-400
Casco Skate
taglie S, M, L
Skate helmet

ad esaurimento
until available

28,85€

Art. 681171
Set 3 protezioni Junior
Junior protections

31,80€

Art. 132171
Set 3 protezioni Senior
(misura S, M, L)
Senior protections



ad esaurimento
until available



pg.54

44,65€

Art. GDA20
Bersaglio elettronico
per il gioco delle
freccette (incluse 6
freccette e 40 punte di
ricambio)
Darts electronic target
(including 6 darts and 40
spare tips)

FORNITURE ■ ■ ■ ■ & STAMPE ■ ■ ■ ■

FORNITURE ■ ■ ■ ■ & STAMPE ■ ■ ■ ■

FORNITURE ■ ■ ■ ■ & STAMPE ■ ■ ■ ■



Art. SKJP-G

69,20€

Pattino in line
allungabile Junior
taglie: 30/33 - 34/37 - 38/41
In line skate adjustable size

ad esaurimento
until available



FORNITURE ■ ■ ■ ■ & STAMPE ■ ■ ■ ■

FORNITURE ■ ■ ■ ■ & STAMPE ■ ■ ■ ■

FORNITURE ■ ■ ■ ■ & STAMPE ■ ■ ■ ■



119,90€

Art. ML9200
Monopattino
pieghevole,
ruote Ø mm. 200
peso massimo
utilizzatore kg. 100
Scooter

pg.54

ad esaurimento
until available



Art. ML8125
Monopattino
pieghevole,
ruote Ø mm. 125
peso massimo
utilizzatore kg. 50
Junior Scooter

69,50€

32,15€

pg.54

Art. AHF-084
Bastoncini
Nordic
Walking
con altezza
regolabile da
65 a 135 cm.
(3 tipi di punte
incluse)
Nordic Walking
sticks with adjustable
height from
65 to 135 cm.
(3 types of tips included)



7,60€

Art. FRPPR
Frisbee
Ø cm. 27
gr. 110
Frisbee

INDICE ALFABETICO

Archi di precisione - Precision Arcs	pag.	47
Arredi spogliatoio ed infermeria - Locker and infirmary room	pag.	168-173
Arti marziali, Boxe - Boxing, Martial Arts	pag.	212-213;218
Atletica - Track and Field	pag.	226-229
Attrezzi speciali, Scalette e Bande elastiche - Special Training tools, Speed Ladders and Elastic Bands	pag.	72-88
Badminton	pag.	211
Bandierine e accessori per arbitro - Flags and referee's accessories	pag.	118-123
Barriera filtrante, Barriera con finestre - Reflex Training Device, Window Barrier	pag.	50
Basket	pag.	177-184
Beach Soccer	pag.	175
Beach Volley	pag.	192-193
Borse - Bags	pag.	136-137
Casacche, Pantaloncini, Calze - Mesh shirts, Shorts, Socks	pag.	100-101
Contenitori Portapalloni - Baskets for balls	pag.	135
Cross Training, Reti per calci di precisione - Cross Training, Precision shooting nets	pag.	152-153
Delimitatori e Birilli - Markers and Cones	pag.	30-34
Deviatori di traiettoria, Ball Playning - Deviators, Ball Playning	pag.	61-63
Fitness Equipment	pag.	90-98
Forche - Heading Trellises	pag.	48-49
Ghiaccio, Tape, Creme, Oli - Ice, Tape, Creams, Oils	pag.	114-115
Ginnastica - Gymnastic	pag.	221-225
Hockey, Baseball	pag.	214-215
Impianti Multifunzione - Multi purpose systems	pag.	196
Kit Calcio Tennis - Soccer Tennis kits	pag.	44-46
Kit tecnico Scuola Calcio - Soccer School kit	pag.	89
Lavagne Tattiche - Tactical Boards	pag.	110-113
Materassi, Protezioni Murarie - Mats, Wall Protections	pag.	216-217;220
Materassini, Borracce - Mats, Water Bottles	pag.	109;116-117
Minivolley, Superminivolley	pag.	191
Muri e Telai con rete - Rebounders and Iron Frames with net	pag.	51-60
Numeri Termosaldabili - Numbers for uniforms	pag.	108
Ostacoli ad altezza fissa e regolabile - Hurdles fixed and adjustable heights	pag.	29;35-43
Paletti Slalom - Slalom Poles	pag.	25-28
Pallamano - Handball	pag.	197
Palle Mediche, Ritmiche e Psicomotorie - Medicine, Rhythmic and Gym Balls	pag.	130-133
Palloni in pelle ed in gomma - Leather and rubber Balls	pag.	126-129
Panchine Allenatori - Trainers' Dug-outs	pag.	155-161
Parastinchi, Fasce Capitano, Guanti Portiere - Shinguards, Captain Armbands, GK Gloves	pag.	106-107
Pilates, Didattica Scolastica, Pattini e Skateboard - Pilates, School Products, Skates	pag.	230-233
Piscina, Pallanuoto - Swimming Pool, Waterpolo	pag.	208-210
Pompe, Compressore, Cronometro e Rotelle Metriche - Pumps, Inflator, Chronometer, Measuring Tapes	pag.	124-125
Porte regolamentari, ridotte, miniporte, porte bifrontali - Official goals, reduced goals, minigoals, 2 side goals	pag.	138-147
Protezioni - Protections	pag.	194-195
Reti di Protezione - Protection Nets	pag.	154
Reti regolamentari e ridotte - Nets all sizes	pag.	148-151
Rugby	pag.	206-207
Sagome e Barriere - Mannequins and Barriers	pag.	12-24
Sedute per gradinate e Tribune modulari per interno ed esterno - Stadium seats and Stands	pag.	165-167
Segnalatori manuali ed elettronici per cambio giocatori - Substitution Boards	pag.	122-123
Strutture instabili e Tavolette Propriocettive, Plinti - Equilibrium Boards	pag.	64-70
Tabelloni elettronici segnapunti - Electronic scoreboards	pag.	198-200
Tacchetti ed accessori per scarpe, Lavascarpe - Studs and shoe accessories, Shoe Washing Device	pag.	102-105
Tavoli calcetto - Soccer tables	pag.	176
Tennis Tavolo - Table Tennis	pag.	204-205
Tennis, Beach Tennis, Padel, Pickleball	pag.	201-203
Trampolini - Trampolines	pag.	71
Tunnel uscita spogliatoi - Stadium Tunnels	pag.	174
Vernice Segnacampo, Carrelli traccialinee - Ecological Paint, Line Markers	pag.	162-164
Volley	pag.	185-190



FORNITURE ■ ■ ■ ■
& STAMPE

FORNITURE ■ ■ ■ ■
& STAMPE

FORNITURE ■ ■ ■ ■
& STAMPE

FORNITURE ■ ■ ■ ■
& STAMPE

FORNITURE ■ ■ ■ ■
& STAMPE

FORNITURE ■ ■ ■ ■
& STAMPE

FORNITURE ■ ■ ■ ■
& STAMPE

FORNITURE ■ ■ ■ ■
& STAMPE

FORNITURE ■ ■ ■ ■
& STAMPE

FORNITURE ■ ■ ■ ■
& STAMPE

FORNITURE ■ ■ ■ ■
& STAMPE

FORNITURE ■ ■ ■ ■
& STAMPE

FORNITURE ■ ■ ■ ■
& STAMPE

FORNITURE ■ ■ ■ ■
& STAMPE

FORNITURE ■ ■ ■ ■
& STAMPE



NEW VIDEOS ON
WWW.BARRETSport.COM



ATTREZZATURE PER L'ALLENAMENTO DEI CAMPIONI
TRAINING TOOLS FOR CHAMPIONS



BARRET SRL
Via Marie Curie, 6/8
Zona Ind.le S. Pietro in Palazzi
57023 Cecina (LI) - Italy
tel. (+39) 0586 661215
fax (+39) 0586 662417
info@barretsport.com
www.barretsport.com



**catalogo
2024-2025
brochure**

GET READY FOR THE MATCH!